

# MASTOLOGY

*Official Journal of the Brazilian Society of Mastology*

Volume 30, 2020

ISSN 2594-5394



# MASTOLOGY

*Official Journal of the Brazilian Society of Mastology*

---

Volume 30, 2020

---

## **EDITOR-IN-CHIEF**

Gil Facina (São Paulo, SP, Brazil)

---

## **CO-EDITORS**

Francisco Pimentel Cavalcante (Fortaleza, CE, Brazil)

Régis Resende Paulinelli (Goiânia, GO, Brazil)

Rene Aloisio da Costa Vieira (Barretos, SP, Brazil)

## **SPECIALTY EDITORS: MASTOLOGY**

André Mattar (São Paulo, SP, Brazil)

Alfredo Carlos Simões Dornellas de Barros (São Paulo, SP, Brazil)

Antonio Luiz Frasson (Porto Alegre, RS, Brazil)

Benedito Borges da Silva (Teresina, PI, Brazil)

Cassio Cardoso Filho (Campinas, SP, Brazil)

César Cabello dos Santos (Campinas, SP, Brazil)

Cícero de Andrade Urban (Curitiba, PR, Brazil)

Daniel de Araújo Brito Buttros (Rio Claro, SP, Brazil)

Daniel Guimarães Tiezzi (Ribeirao Preto, SP, Brazil)

Délio Marques Conde (Goiania, GO, Brazil)

Eduardo Camargo Millen (Rio de Janeiro, RJ, Brazil)

Fabiana Baroni Makdissi (São Paulo, SP, Brazil)

Fábio Bagnoli (São Paulo, SP, Brazil)

Fabio Postiglione Mansani (Ponta Grossa, PR, Brazil)

Fabrizio Palermo Brenelli (Campinas, SP, Brazil)

Felipe Pereira Zerwes (Porto Alegre, RS, Brazil)

Gustavo Antonio de Souza (Campinas, SP, Brazil)

Gustavo Zucca-Matthes (Barretos, SP, Brazil)

José Luiz B Bevilacqua (São Paulo, SP, Brazil)

José Luiz Pedrini (Porto Alegre, RS, Brazil)

José Mauro Secco (Macapa, AP, Brazil)

José Roberto Filassi (São Paulo, SP, Brazil)

José Roberto Morales Piato (São Paulo, SP, Brazil)

Jurandyr Moreira de Andrade (Ribeirao Preto, SP, Brazil)

Luís Otávio Zanatta Sarian (Campinas, SP, Brazil)

Luiz Henrique Gebrim (São Paulo, SP, Brazil)

Marcelo Madeira (São Paulo, SP, Brazil)

Renato Zocchio Torresan (Campinas, SP, Brazil)

Roberto José S. Vieira (Rio de Janeiro, RJ, Brazil)

Rodrigo Gonçalves (São Paulo, SP, Brazil)

Rogério Fenile (São Paulo, SP, Brazil)

Rosemar Macedo Sousa Rahal (Goiania, GO, Brazil)

Ruffo de Freitas Júnior (Goiania, GO, Brazil)

Vinícius Milani Budel (Curitiba, PR, Brazil)

Vilmar Marques de Oliveira (São Paulo, SP, Brazil)

## **INTERNATIONAL ADVISORY BOARD**

Marcelo Cruz (Chicago, USA)  
Otto Metzger Filho (Boston, USA)  
Bejnamin Anderson (Seattle, USA)  
Eduardo González (Buenos Aires, Argentina)  
Gail Lebovic (Dallas, USA)  
Luciane Cavalli (Washington, USA)  
Luiz Javier Gallón (Medellín, Colombia)  
Jaime Letzkus Berríos (Santiago, Chile)  
Juan Enrique Bargallo Rocha (Mexico City, Mexico)  
Mahmoud El-Tamer (New York, USA)  
Maria João Cardoso (Lisbon, Portugal)  
Mario Rietjens (Milan, Italy)  
Matthew Ellis (Houston, USA)  
Melissa Bondy (Houston, USA)  
Richard Raisburry (London, UK)  
Rui Manuel Reis (Braga, Portugal)  
Vesna Bjelic Radisic (Vienna, Austria)  
Virgilio Sacchini (Milan, Italy)

## **SPECIALTY EDITORS: PATHOLOGY**

Ângela Flávia Logullo Waitzberg (São Paulo, SP, Brazil)  
Helenice Gobbi (Belo Horizonte, MG, Brazil)

## **SPECIALTY EDITOR: PHYSIOTHERAPY**

Anke Bergmann (Rio de Janeiro, RJ, Brazil)  
Samantha Karla Lopes de Almeida Rizzi (São Paulo, SP, Brazil)

## **SPECIALTY EDITOR: TRANSLATIONAL RESEARCH**

Gustavo Arantes Rosa Maciel (São Paulo, SP, Brazil)  
Tatiana Carvalho de Souza Bonetti (São Paulo, SP, Brazil)

## **SPECIALTY EDITORS: GENETICS**

José Cláudio Casali da Rocha (Curitiba, PR, Brazil)  
Maria Isabel Achatz (São Paulo, SP, Brazil)

## **SPECIALTY EDITORS: MEDICAL ONCOLOGY**

Carlos Barrios (Porto Alegre, RS, Brazil)  
Max Mano (São Paulo, SP, Brazil)  
Sérgio Simon (São Paulo, SP, Brazil)

## **SPECIALTY EDITORS: RADIOTHERAPY**

Nilceana Maya Aires Freitas (Goiânia GO Brazil)  
Rodrigo Souza Dias (São Paulo, SP, Brazil)  
Samir Abdallah Hanna (São Paulo, SP, Brazil)

## **SPECIALTY EDITORS: RADIOLOGY**

Helio Amâncio Camargo (São Paulo, SP, Brazil)  
Simone Elias Martinelli (São Paulo, SP, Brazil)

## **SPECIALTY EDITORS: EPIDEMIOLOGY AND PREVENTION**

Edesio Martins (Goiânia, GO, Brazil)  
Luiz Cláudio Santos Thuler (Rio de Janeiro, RJ, Brazil)

## FORMER PRESIDENTS

Alberto Lima de Morais Coutinho (1959–1961)  
Jorge de Marsillac (1962–1963)  
Eduardo Santos Machado (1964–1965)  
Carlos A. M. Zanotta (1966–1967)  
Alberto Lima de Morais Coutinho (1968–1969)  
Adayr Eiras de Araújo (1970–1971)  
João Luiz Campos Soares (1972–1973)  
Jorge de Marsillac (1974–1975)  
Alberto Lima de Morais Coutinho (1976–1977)  
João Sampaio Góis Jr. (1978–1982)  
Hiram Silveira Lucas (1983–1986)  
José Antonio Ribeiro Filho (1987–1989)  
Antônio S. S. Figueira Filho (1990–1992)  
Marconi Menezes Luna (1993–1995)  
Henrique Moraes Salvador Silva (1996–1998)  
Alfredo Carlos S. D. Barros (1999–2001)  
Ezio Novais Dias (2002–2004)  
Diógenes Luiz Basegio (2005–2007)  
Carlos Ricardo Chagas (2008–2010)  
Carlos Alberto Ruiz (2011–2013)  
Ruffo de Freitas Júnior (2014–2016)  
Antonio Luiz Frasson (2017-2019)



## BRAZILIAN SOCIETY OF MASTOLOGY

Praça Floriano, 55, sala 801, Centro – 20031-050 – Rio de Janeiro (RJ)  
Phone numbers: (21) 2220-7711 / (21) 2220-7111  
E-mail: [contact@mastology.org](mailto:contact@mastology.org)

## ABOUT

Mastology is a publication of the Brazilian Society of Mastology. The responsibility for concepts emitted in the articles is exclusive of its authors

The total or partial reproduction of the articles is allowed, provided the source is mentioned.

Founder: Antônio Figueira Filho

Submissions - mailing address: Praça Floriano, 55, sala 801, Centro – Rio de Janeiro (RJ) – 20031-050

National and international subscription and advertising: Brazilian Society of Mastology - Phone number: (21) 2220-7711 - Whatsapp (21) 98138-0034

## NATIONAL BOARD OF DIRECTORS OF SOCIEDADE BRASILEIRA DE MASTOLOGIA

### Triennium 2020-2022

#### Founder:

President	Alberto Lima de Morais Coutinho
National Vice President	Vilmar Marques de Oliveira
North Region Vice President	Vinicius Milani Budel
Northeast Region Vice President	Francianne Silva Rocha
South Region Vice President	Darley de Lima Ferreira Filho
Southeast Region Vice President	Jorge Villanova Biazus
Midwest Region Vice President	César Cabello dos Santos
General secretary	Carlos Marino Cabral Calvano Filho
Assistant Secretary	Rosemar Macedo Sousa Rahal
General Treasurer	Sandra Marques Silva Gioia
Assistant Treasurer	Felipe Eduardo Martins de Andrade
Mastology Editor	Aleksandr Salamanca Miyahira
Escola Brasileira de Mastologia Director	Gil Facina
Deliberative Council President	Fabio Postiglione Mansani
TEMa Committee	Antonio Luiz Frasson
Ethics Committee	Eduardo Camargo Millen
Scientific Committee	Clécio Ênio Murta de Lucena
	Alfredo Carlos Simões Dornellas de Barros

#### PRODUÇÃO EDITORIAL



Rua Bela Cintra, 178, Cerqueira César – São Paulo/SP – CEP 01415-000  
Tel: 55 11 2978-6686 – [www.zepellini.com.br](http://www.zepellini.com.br)

# Breast cancer care during the coronavirus pandemic

Gil Facina<sup>1\*</sup> , Vilmar Marques de Oliveira<sup>1</sup> 

The coronavirus disease 2019 (COVID-19) is caused by the virus SARS-CoV-2, a new coronavirus detected in December 2019 in Wuhan, China.<sup>1</sup> Due to its highly contagious nature, the disease quickly spread over the world, and, on March 11, 2020, the World Health Organization declared the infection outbreak as the first pandemic caused by a coronavirus.<sup>2</sup> On April 17, 2020, COVID-19 had reached 210 countries, infected over 2.2 million people, and caused more than 150 thousand deaths.<sup>3</sup> Most infected individuals develop mild to moderate respiratory symptoms; however, older adults or those with health conditions, such as diabetes mellitus, cardiovascular disease, hypertension, chronic respiratory disease, chronic kidney disease, and immunodepression, may present severe forms of COVID-19 and require intensive medical care, with hospitalization and clinical and ventilatory support. It is worth mentioning that cancer patients are more susceptible to infections, either by the immunosuppressed state inherent to the disease or the necessary antineoplastic treatment, such as chemotherapy, targeted therapy, and immunotherapy.<sup>1</sup>

In order to preserve and provide essential resources to fight the pandemic, public and private hospital services are forced to reduce the supply for routine care. Thus, patients and physicians must adapt to this new reality, seek protection against contamination in the work environment, and understand that the number of beds available for elective hospitalizations and emergency treatments is low. In addition, the cancer patient faces a higher risk of contamination by the new coronavirus in a saturated hospital environment. Yu et al. reviewed data from 1,525 cancer patients treated at a tertiary hospital in Wuhan, comparing the incidence of COVID-19 in these individuals with that of the general local population, and noted that the risk of infection by SARS-CoV-2 was significantly greater among the first group (odds ratio – OR=2.31; 95% confidence interval – 95%CI 1.89–3.02).<sup>4</sup>

In recent weeks, much has been discussed about adjustments to the care of cancer patients not infected by the new coronavirus during the pandemic to minimize the risk of contamination, without compromising the outcome of the disease. Some associations summarized recommendations that should be periodically

adapted, given the rapid dissemination of COVID-19 and the local availability of resources.<sup>4,5</sup>

## RECOMMENDATIONS FOR THE CARE OF BREAST CANCER PATIENTS DURING THE COVID-19 PANDEMIC

- Adopt the use of telemedicine (Office Letter from the Federal Council of Medicine no. 1.756/2020, March 19, 2020) on an exceptional basis during the fight against the COVID-19 for the remote instruction of patients in isolation, medical supervision of health parameters and/or disease, and exchange of information and opinions among physicians;<sup>6</sup>
- Schedule appointments with greater interval to reduce the contact between individuals in the waiting room;
- Decrease the number of companions in appointments;
- Keep a safe distance between the patient and health professionals;
- Do not make greeting gestures;
- Wash and sanitize the hands before and after the physical examination;
- Always use disposable gloves during the physical examination;
- Inform the patient about the signs and symptoms of COVID-19;
- Counsel the patient on social distancing and day-to-day hygiene;
- Offer the diagnostic test for the symptomatic patient;
- Postpone elective surgeries when possible. The decision should be individualized, based on common sense, multidisciplinary, and shared with the patient. The surgeries indicated must respect the hospital resources available, depending on the phase of the pandemic. In the initial phase (phase I) of the COVID-19 pandemic in a region, the hospital resources are still reasonable. Thus, patients who would have their survival impaired if not operated within the next three months should undergo surgery. Patients who have non-urgent surgeries postponed should be informed that the decisions were made by consensus and based on local resources, due to the prevalence of COVID-19, as well as the characteristics

<sup>1</sup>Escola Paulista de Medicina, Universidade Federal de São Paulo – São Paulo (SP), Brazil.

\*Corresponding author: facina@unifesp.br

Conflict of interests: nothing to declare.

Received on: 04/03/2020. Accepted on: 04/03/2020

of the tumor and the expected results related to the delay. All information and instructions must be included in the medical records. In the next phase (phase II), hospital resources are scarce, with a limited number of respirators and intensive care unit beds. Surgeries are restricted to patients who would not survive a few days if not operated. Among these conditions, abscess drainage, hematomas, and review of flap ischemia (reconstructions with autologous flaps must not be performed) stand out. In phase III, no respirators or beds are available for admission. Virtually all hospital resources are consumed. At this stage, the surgeries are restricted to patients who would not survive a few hours if not operated;

- Postpone, discontinue, or modify the radiotherapy, when possible, depending on the risk of contamination and the clinical indication;
- Individualize the systemic therapy, grounding the measure in the likelihood of recurrence. Some patients can receive home infusions or change intravenous for oral therapy to reduce the number of visits to hospital units.

In short, the pandemic caused by the new coronavirus SARS-CoV-2 has an uncertain trajectory and represents a great challenge both economically and emotionally.<sup>7</sup> It is the moment to learn and prepare for the huge impact that this outbreak might have on the appropriate support to cancer patients.

## REFERENCES

1. Shankar A, Saini D, Roy S, Mosavi Jarrahi A, Chakraborty A, Bharti SJ, et al. Cancer Care Delivery Challenges Amidst Coronavirus Disease - 19 (COVID-19) Outbreak: Specific Precautions for Cancer Patients and Cancer Care Providers to Prevent Spread. *Asian Pac J Cancer Prev*. 2020;21(3):569-73. <https://doi.org/10.31557/APJCP.2020.21.3.569>
2. World Health Organization. WHO Director-General's opening remarks at the media briefing on COVID-19 [Internet]. World Health Organization; 2020 [acessado em 2 abr. 2020]. Disponível em: <https://www.who.int/dg/speeches/detail/who-director-general-s-opening-remarks-at-the-media-briefing-on-covid-19--11-march-2020>
3. Worldometers. COVID-19 coronavirus pandemic [Internet]. Worldometers; 2020 [acessado em 2 abr. 2020]. Disponível em: <https://www.worldometers.info/coronavirus/>
4. Yu J, Ouyang W, Chua MLK, Xie C. SARS-CoV-2 Transmission in Patients With Cancer at a Tertiary Care Hospital in Wuhan, China. *JAMA Oncol*. 2020:e200980. <https://dx.doi.org/10.1001%2Fjamaoncol.2020.0980>
5. American College of Surgeons. COVID-19 Guidelines for Triage of Breast Cancer Patients. American College of Surgeons; 2020 [acessado em 2 abr. 2020]. Disponível em: <https://www.facs.org/covid-19/clinical-guidance/elective-case/breast-cancer>
6. Conselho Federal de Medicina. Ofício CFM nº 1756/2020 – COJUR. Conselho Federal de Medicina; 2020 [acessado em 3 abr. 2020]. Disponível em: [http://portal.cfm.org.br/images/PDF/2020\\_oficio\\_telemedicina.pdf](http://portal.cfm.org.br/images/PDF/2020_oficio_telemedicina.pdf)
7. Ueda M, Martins R, Hendrie PC, McDonnell T, Crews JR, Wong TL, et al. Managing Cancer Care During the COVID-19 Pandemic: Agility and Collaboration Toward a Common Goal. *J Natl Compr Canc Netw*. 2020;1-4. <https://doi.org/10.6004/jnccn.2020.7560>



# Looking back to 50 years of a surgeon's career: combining assistance, education, and research

Jean-Yves Petit<sup>1</sup> , Cicero Urban<sup>2</sup> 

A long time ago, I was sixteen and wanted to be an artist, a painter.

My father was a doctor, he wanted me to become a doctor, a surgeon like his father... He wanted to put me on the right family track! I did not resist so much. Being a surgeon was a prestigious job, in my opinion.

I was not the kind of intellectual nor very fond of reading books. I got my degrees working moderately at the university, impatient to become a surgical resident, despite the difficulty and the hard selection of the competitive examination.

As soon as I could start working at the hospital, I knew that my choice for this profession was right. Besides that, to confirm my likelihood of learning with practice more than with books, I remember learning my first surgical knowledge mostly in the operating room more than in the library.

What kinds of surgery? During my residency training, I experienced several specialties, such as visceral, cervico-facial, orthopedic... and, finally, plastic surgery. I was not interested

in the kind of patients usually looking for esthetic surgery as well as private practice, which is mostly performed in this specialty. I was mainly trained in a cancer institute (Gustave Roussy Cancer Institute), where I also acquired my competence in plastic surgery. In Gustave Roussy, I got the position of Head of the Department of Breast Cancer, including breast reconstructions and skin cancer treatments.

At this point of my surgical status, I should add a comment about this period of my life, which influenced my thoughts about society. First, I started to raise questions when I came back from a trip to China in 1966. Then, when I was chief resident in Gustave-Roussy Cancer Institute, the political events of 1968 were happening everywhere in France, and noisy demonstrations were surrounding the hospital. I could not help but being strongly committed to these events. I participated in a group whose purpose was to question the abuse of medical power over patients. We wanted to help patients to know more about their disease, and better understand and accept the type of surgical treatment required. Moreover, I participated as a committed fighter in favor of abortion freedom, as well as for the women's lib movement.

Coming back to my activities at Gustave Roussy Cancer Institute, I took the opportunity of combining my competence on both reconstructive surgery and breast surgery to develop the breast reconstructive activity. In 1975, it was the very beginning of breast reconstruction. The first trials of breast conserving surgery in breast cancer were just starting. Mastectomy was still the usual treatment. Therefore, the patients had a new demand for psychologic improvement after mastectomy. I started to perform reconstructions with silicone implants (already used at this time, in 1975, for esthetic surgery), keeping indications only for good prognostic patients, such as *in situ* cancers with at least several years of follow up without recurrences. Radiotherapy was also indicated, sometimes providing poor local tissue conditions. In the late seventies, John Bostwick proposed the use of a muscular flap: the latissimus dorsi transposition with an island of skin paddle to replace the radiated tissue. Several years



<sup>1</sup>Plastic Surgery Department, European Institute of Oncology – Milan, Italy.

<sup>2</sup>Breast Unit, Hospital Nossa Senhora das Graças – Curitiba (PR), Brazil.

\*Corresponding author: cicerourban@hotmail.com

Conflict of interests: nothing to declare.

Received on: 06/01/2020. Accepted on: 06/02/2020

later, Carl Hartrampf invented the TRAM flap reconstruction. I went to Atlanta to learn the technique. Carl was a very nice person and invited me to stay in the OR during his operation. Incidentally, we were two privileged surgeons to stay in the OR behind the camera for the video transmission to the course. Back then, my English was not so fluent and, when discussing with the other invited surgeon after not having understood his name, I was asking him where he was from, what was his position in LA, trying to be polite... and, finally, what was his name? He was Mac Kissok! One of the most famous plastic surgeons, the father of the worldwide well-known technique of reduction mammoplasty. Imagine how stupid I felt!

At Gustave Roussy Institute, the results of our trial on conservative treatment allowed us to include the technique in our protocol of breast cancer treatment in small tumors. In the early eighties, I started to propose techniques of oncoplastic for partial breast reconstruction with poor cosmetic results. It is interesting to show that progress in surgery can result from a combination of different specialties. Although extreme specialization should be required in microsurgical techniques, for instance, improvement of psychological results in breast cancer treatment could be obtained with the association of general cancer surgery and plastic surgery techniques.

Likewise, working in a cancer team was familiar to me as to the role of statistics to evaluate any kind of results. It helped me to write papers with more reliable results than those produced by pure plastic surgeons.

In October 1994, I got the opportunity to move to the European Institute of Oncology (EIO), a new cancer institute of Umberto Veronesi, in Milan. He took me on to become Head of the Plastic Surgery Department of the brand-new hospital, which had been open for two months only!

It was not so easy to change all my habits of daily work, especially with my very poor Italian. But there was great enthusiasm among all the new teams coming from different countries. We aimed to build a truly international institute.



I brought along my young Brazilian assistant, Mario Rietjens, who was working with me in Paris for many years. He truly helped me raise our new team. Then, we took on Cristina Garusi, a young Italian plastic surgeon. Mario and I were both trained in general and plastic surgery. The team grew slowly with the inclusion of Francesca De Lorenzi, who was also a pure plastic surgeon, and several other young assistants who came in.

At Gustave Roussy Institute, I was in charge of both the cancer and the reconstructive breast surgery, whereas in Milan, Veronesi asked me to limit my activity to reconstructive surgery, like it is done in the US.

I was very happy in Italy, thanks to the research dynamism implemented by Veronesi and the other teams. Among the other heads of different departments, most were internationally recognized oncologists. During the first years, we were greatly encouraged by this experience of an original European Cancer Institute. Veronesi pushed everyone to make research and publish. I did not spend so much time writing papers when I was in Paris...

Many young surgeons spent several months with us, specially to learn about immediate breast reconstruction. Among these fellows coming from abroad, one from Brazil became a big friend: Cicero Urban. He stayed almost one year (or more?) and since that time he remained in close connection both with Mario Rietjens and me. I remember the nice philosophical discussions we shared during dinner after working days. That was the start of a deep friendship between us.

It was a long time ago since I was performing immediate reconstructions in France, whereas the technique was barely known in Italy. Many patients came to the EIO to benefit from this new technique in the country<sup>1-3</sup>.

It was also the first time that patients were offered a possibility of partial breast reconstructions<sup>2</sup>. Symmetry procedures were also proposed to improve the final psychological status of patients. In the beginning, women were often reluctant to having their virgin breasts and we obviously always let them decide, except when there was some reason to check abnormalities, such as microcalcifications in a normal breast.

Microsurgical reconstruction was also introduced later in our protocols, thanks to the nice work of Cristina Garusi. She became an important international expert in microsurgical meetings.

The last technical evolution in my department was the introduction of fat grafting, which derived from the esthetic technique of liposuction<sup>2</sup>. The technique rapidly developed, especially for conservative treatment morphology improvement, but also to improve all kinds of total breast reconstructions. Finally, our purpose was to reconstruct the breast only with a fat graft. Good results were obtained, although requiring too many operating sessions.

My question remained focused on proving the oncologic innocuity of this technique. Experimental research was made in the EIO laboratory of Francesco Bertolini. On animal experiments,



he showed that the transposed fat was able to stimulate the growth of cancer cells and metastasis. Several clinical retrospective studies performed in our department did not confirm such recurrence risk in our patients. However, I set up a randomized trial including conservative treatment patients with immediate fat grafting to evaluate both the morphologic improvement and the cancer risk with a Chinese team two years ago, with whom I

was scientifically connected for many years. The results will be available in two or three years probably<sup>2</sup>.

Breast cancer treatment may no longer be invasive in the future, avoiding psychological disasters. Despite such hope, surgery remains one of the major resources against the disease, providing a higher percentage of cure when associated with other medical treatments, including radiotherapy.

## REFERENCES

1. Kaur N, Petit JY, Rietjens M, Maffini F, Luini A, Gatti G, et al. Comparative study of surgical margins in oncoplastic surgery and quadrantectomy in breast cancer. *Ann Surg Oncol*. 2005;12(7):539-45. <http://doi.org/10.1245/ASO.2005.12.046>
2. Petit JY, Clough K, Sarfati I, Lohsiriwat V, de Lorenzi F, Rietjens M. Lipofilling in breast cancer patients: from surgical technique to oncologic point of view. *Plast Reconstr Surg*. 2010;126(5):262e-3e. <http://doi.org/10.1097/PRS.0b013e3181ef94a8>
3. Petit JY, Veronesi U, Luini A, Orecchia R, Rey PC, Martella S, et al. When mastectomy becomes inevitable: the nipple-sparing approach. *Breast*. 2005;14(6):527-31. <http://doi.org/10.1016/j.breast.2005.08.028>



# COVID-19 and breast cancer: Should we change prevention, control, and treatment strategies or intelligently rationalize our practice?

Eduardo González<sup>1\*</sup> 

You will not be right or wrong because the crowd does not agree with you. You will be right because your data and reasoning are correct (Benjamín Graham).

On December 12<sup>th</sup>, 2019, the world was routinely normal and the news very briefly mentioned some cases of a rare viral pneumonia observed in Wuhan, Hubei province, China.

Between December 30<sup>th</sup> and January 3<sup>rd</sup>, 2020 everything changed drastically. A rare epidemic was first reported in a chat and was later denied in a document by the very same person who reported it, the Chinese ophthalmologist Li Weliang, under pressure from the country's government "accusing him of spreading false rumors"<sup>1</sup>.

Two days later, the World Health Organization (WHO) issued an alert regarding an outbreak of pneumonia of unknown etiology in Wuhan<sup>2</sup>, and only on January 7<sup>th</sup> did the Chinese authorities report having identified a new virus causing the new disease, 2019-nCoV<sup>3</sup>.

On February 6<sup>th</sup>, Li Weliang died of coronavirus. And then chaos was unleashed — cases multiplied, the disease spread to various countries and continents and the concept of "normal" life have probably changed forever.

The first test to show that the aggressive quarantine approach was the right way to go was published in late February by a WHO commission that visited several Chinese cities. Unfortunately, the Chinese example was not replicated in many countries<sup>4</sup>.

The final corollary of the start of this new global scenario occurs on March 11<sup>th</sup>, 2020, when the WHO declares that the outbreak of the disease, renamed COVID-19, is a Pandemic.

What is the purpose of this editorial? Indeed, one must accept that the concepts of private and social lives and medical practice, as we know it, will be no more, and not to accept it as it is would be foolish; but accepting it does not mean being submissive as a herd (later I will delve into this concept), given the overwhelming amount of information in our times, in dozens of scientific articles and recommendations published every day online (more

than 6,000 in PubMed) and on social networks, which combine solid data with rumors and fake news.

People are constantly stating that the human kind faces an unknown and threatening disease that is often severe and deadly, that health systems are overloaded, that there is no proven treatment to date, that vaccines will not be available in a short period of time, and that a situation like this has not occurred since the influenza pandemic in 1918.

Is this an unquestionable reality, though? Is it the same for all countries with different demographic densities, geographies, climates and health policies? Is it the same for all the provinces, cities, and counties of our country?

Now, pointedly regarding our specialty, how should we proceed in the face of this new challenge? Changing our diagnostic and therapeutic strategies? Changing our prevention strategies? Should we avoid under-treating tumors for fear of the pandemic? Should we put ourselves on the brinks of ethical conflict upon having to decide who should be controlled and/or treated and who should wait?

Provided we analyze the personal and the collective in our professional activities, how should we take care of ourselves? How to care for patients? What new legal conflicts can we face? How is this new scenario going to impact our mental health and quality of life? What precautions can and should we take?

Thus, I will honestly and modestly give you my impressions on these matters, based on more than 40 years of profession, most of which practicing Mastology, and having the same experience in the pandemic as all of you, practically nil, apart from solely information with levels of evidence 5. I am not an epidemiologist, nor an infectious disease physician or a pulmonologist. My role, as yours, is to treat my breast cancer patients in the most medically and ethically correct way and to avoid the work team's contagion.

In order to answer these questions, I need first to go back to the definition of the term "herd". It was used in this Pandemic to explain the policy of some countries such as the United

<sup>1</sup>Department of Mastology, Universidad de Buenos Aires – Buenos Aires, Argentina.

\*Corresponding author: egonzalez57@hotmail.com

Conflict of interests: nothing to declare.

Received on: 01/06/2020. Accepted on: 02/06/2020

Kingdom, where the Prime Minister introduced it to achieve “collective immunity” with widespread exposure of the majority of the population and to thus avoid future epidemics. It did not go well, to such an extent that he ended up in an intensive care unit as a victim of the disease and of his own strategy.

In fact, I would like to use another term for it, also conceptualized as “gregarious behavior”, which has to do with “the tendency to accept the reasoning or ideas of the majority as valid without analyzing whether they are logically correct”. To date, doctors are probably acting guided by many contradictory recommendations, or ones established for other realities, situations or institutions, and which are not rationalized by passing on through the filter of our experience and common sense.

The best way to avoid the “herd effect” is to ask ourselves: What data are we basing ourselves on? Is there a scientific study that confirms this? Is there a scientific study that denies it? Are these studies rigorous? Does it make sense from a logical point of view?

You have probably read the recommendations of various international organizations, consensus and even pieces published by SAM<sup>5-10</sup> on the management of breast cancer in this situation.

In general, they are all based on different scenarios and stages of the pandemic, so they only serve as models to be evaluated and adapted to each institution with its advantages and disadvantages, its estimation of supplies, availability of normal hospital beds, of feverish patients (COVID + or not) or intensive care ones, staff turnover, possibility of serial tests, infected quarantined staff with or without symptoms of the disease.

For example, systematic testing depends on a country’s or institution’s health possibilities and the risk groups included therein; however, these priority criteria have been expanded for various reasons. To date, the WHO has recommended all countries to massively perform diagnostic test.

Then, what should we do or prioritize with these recommendations? I believe there is only one answer: to rationalize them, and to do it personally and intelligently, contemplating the dynamics of the pandemic and our reality at the moment of taking action.

In relation to health personnel, the conduct is clear, we must rotate it, maintain independent work teams equipped with adequate prevention teams and staff, who can continue care in case of infections and treat according to the available means of routinely testing them, in addition to holding continuous multidisciplinary videoconference meetings for assistance and decision-making, information, physical prevention and individual and group psychological support<sup>11,12</sup>.

Regarding patients, the conduct should be telephone or e-mail assistance prioritizing control consultations to balance the cost-benefit of postponing the visit to lower the risk of contagion, mandatory triage, questioning about the history of possible exposure, indication and detailed information on the conduct decided by the multidisciplinary team of risks related to the treatments and the possible occurrence of COVID, prior testing of patients who will undergo surgical and/or chemotherapy treatments. It is

paramount to take into account the analysis of high-risk groups by age, associated morbidities or immunosuppression.

In relation to the diagnosis, control or screening studies in asymptomatic women and, in some situations, studies on previous injuries categorized as Birad 3, should probably be postponed. In the remainder of the situations, studies should be done considering each case individually.

As for treatment, the institution’s overall status and the stage of complexity of the pandemic should be assessed at all times, and if the two parameters are favorable, conventional treatments should be indicated, taking the previously mentioned safety precautions by both patients and surgical teams (screening, interview, testing, etc.). It should be noted that we are talking about oncological surgeries with or without previous neoadjuvant, favorable or advanced primary tumors that may include immediate reconstructions with expanders or prostheses or mastoplasty techniques that do not significantly increase surgical time nor increase the costs on essential supplies as well as any type of complication that needs to be resolved in the operating room. It makes no sense, at this time, to include treatments for benign pathologies, potential risk injuries, risk reduction surgeries, and delayed breast reconstructions.

A special paragraph should be dedicated to patients with asymptomatic COVID and breast cancer in relation to the actions to be taken. Although controversial, it is likely that the most prudent is take a “therapeutic time out” until the tests are negative and treatments can be started in a safer setting to avoid increased postoperative complications<sup>13</sup>.

The fundamentals of providing patients with detailed information about the implications of the pandemic, the safety measures being taken by us, and the multidisciplinary decision-making and its reasons, are never to be forgotten, but rather to be reported into the clinical history and informed consent for signature.

Within time, there are likely to be specific situations that will be analyzed legally in another context and the health team may find itself questioned for behaviors taken in an exceptional situation that generates this global health emergency.

The COVID epidemic started in December 2019. In many countries, the commotion generated by quarantining has faded, the number of infected people is decreasing, and measures on how to lift the blockade are being discussed. But are appearances misleading? Is a second wave approaching? If so, when would it occur? Science continues to advance. Soon, the first drug trials will pay off, and the first vaccines are already being tested.

Once the situation is resolved, what urgent steps will have to be taken in the breast cancer scenario? Will it be possible to return to the starting point?

We should try to quickly return to normality, while still taking advantage of the lessons learned from our personal and group experiences, and to elaborate and define precise contingency plans in case of outbreaks, until we can achieve the long-awaited goal of being able to immunize the entire population.

## REFERENCES

1. Covid Reference. Covid Reference International [Internet]. 2020 [acceso el mar. 2020]. Disponible en: [www.covidreference.com](http://www.covidreference.com)
2. World Health Organization. Pneumonia of unknown cause – China [Internet]. World Health Organization; 2020 [acceso el ene. 2020]. Disponible en: <https://www.who.int/csr/don/05-january-2020-pneumonia-of-unknown-cause-china/en/>
3. Zhu N, Zhang D, Wang W, Li X, Yang B, Song J, et al. A Novel Coronavirus from Patients with Pneumonia in China, 2019. *New Eng J Med*. 2020;382:727-33. <http://doi.org/10.1056/NEJMoa2001017>
4. World Health Organization. Report of the WHO-China Joint Mission on Coronavirus Disease 2019 (COVID-19) [Internet]. World Health Organization; 2020 [acceso el abr. 2020]. Disponible en: [www.who.int/publications-detail/report-of-the-who-china-joint-mission-on-coronavirus-disease-2019-\(COVID-19\)](http://www.who.int/publications-detail/report-of-the-who-china-joint-mission-on-coronavirus-disease-2019-(COVID-19))
5. Argentina. Ministerio de Salud. Recomendaciones para equipos de salud [Internet]. Argentina: Ministerio de Salud; 2020 [acceso el abr. 2020]. Disponible en: <https://www.argentina.gob.ar/coronavirus/equipos-salud>
6. Ueda M, Martins R, Hendrie PC, McDonnell T, Crews JR, Wong TL, et al. Managing Cancer Care During the COVID-19 Pandemic: Agility and Collaboration Toward a Common Goal. *J Natl Compr Canc Netw*. 2020;18(4):1-4. <http://doi.org/10.6004/jnccn.2020.7560>
7. Dietz JR. Recommendations for Prioritization, Treatment and Triage of Breast Cancer Patients During the COVID-19 Pandemic: Executive Summary Version 1.0. The COVID-19 Pandemic Breast Cancer Consortium. *The American Society of Breast Surgeons*; 2020.
8. Asociación Española de Cirujanos. Recomendaciones para la gestión de los pacientes con patología mamaria ante la pandemia por COVID-19 [Internet]. Asociación Española de Cirujanos; 2020 [acceso el mar. 2020]. Disponible en: [https://www.aecirujanos.es/files/noticias/152/documentos/Patologia\\_Mamaria\(3\).pdf](https://www.aecirujanos.es/files/noticias/152/documentos/Patologia_Mamaria(3).pdf)
9. Society of Surgical Oncology. Breast Cancer Management During COVID-19. Society of Surgical Oncology; 2020.
10. Sociedad Argentina de Mastología. Protocolos y normas terapéuticas operativas durante la Pandemia COVID-19 para profesionales de la salud. Argentina: Sociedad Argentina de Mastología; 2020.
11. National Comprehensive Cancer Network. Self-Care and Stress Management during the COVID-19 Crisis: Toolkit for Oncology Healthcare Professionals. National Comprehensive Cancer Network; 2020 [acceso el abr. 2020]. Disponible en: [NCCN.org/covid-19](https://www.nccn.org/covid-19)
12. Brat G, Hersey S, Chhabra K, Gupta A, Scott J. Protecting surgical teams during the COVID-19 outbreak: a narrative review and clinical considerations. *Ann Surg*. 2020. <https://doi.org/10.1097/sla.0000000000003926>
13. Lei S, Jiang F, Su W, Chen C, Chen J, Mei W, et al. Clinical characteristics and outcomes of patients undergoing surgeries during the incubation period of COVID-19 infection. *EClinicalMedicine*. 2020;21. <https://doi.org/10.1016/j.eclinm.2020.100331>



# Correlation between the proportion of healthy mammary tissue versus tumor size in breast-conserving surgeries

Gabriela Grando Pinson<sup>1</sup> , Julianes Pacheco<sup>1</sup> , Vanderlei Carlos Bertuol Júnior<sup>1\*</sup> , Fernando Vivian<sup>1</sup> 

## ABSTRACT

**Objective:** To evaluate the proportion of excised healthy tissue in breast-conserving surgeries and to identify possible tendency toward excision in healthy tissue beyond the ideal for oncological safety. **Methods:** Data from patients who underwent breast-conserving surgery at the Hospital Geral de Caxias do Sul from January 2010 to December 2016 were analyzed. For statistical purposes, means, standard deviations, Student's t-test, and linear regression were used for numerical variables. Risk estimate by odds ratio (OR) was performed through logistic regression with 95% CI. A significance level (alpha) of 5% was adopted. **Results:** A total of 124 cases were analyzed. The mean tumor size observed by ultrasonography was  $1.7 \pm 0.95$  cm. The tumor size by pathology was  $1.9 \pm 1.12$  cm. The mean size of the resected surgical specimens was  $7.8 \pm 3.4$  cm. When comparing the tumor size in the anatomopathological examination and the size in ultrasonography, the mean differences accounted for 0.6 cm (95%CI -0.10–0.44;  $p = 0.2$ ). Conversely, the difference in the size of the total surgical specimen versus tumor size in the anatomopathological examination was 5.8 cm (95%CI 5.2–6.5;  $p < 0.001$ ). There was no statistical difference regarding the tumor location nor size of the surgical specimen. **Conclusion:** It was observed that there is a tendency toward excising a large amount of healthy tissue in breast-conserving surgeries far beyond what is recommended in order to consider the oncological safety of excised margins.

**KEYWORDS:** mastectomy, segmental; margins of excision; breast neoplasms; treatment outcome; esthetics.

## INTRODUCTION

Breast cancer is the tumor that most affects women worldwide. In Brazil, breast cancer mortality rates remain high, probably because the disease is still diagnosed in advanced stages. Population screening programs enabled more diagnoses of early-stage injuries, reducing death cases and promoting less aggressive surgeries<sup>1</sup>. The José Alencar Gomes da Silva Brazilian National Cancer Institute (*Instituto Nacional de Câncer* – INCA) estimated 59,700 new cases of breast cancer in Brazil in 2018<sup>2</sup>. In Caxias do Sul, in the state of Rio Grande do Sul, 46 cases of death from breast cancer were identified in 2016<sup>3</sup>.

Surgical treatment of breast cancer has undergone significant changes in recent decades, and breast-conserving surgery is the standard treatment for the early stages of the disease nowadays<sup>4</sup>.

The radical mastectomy technique and its corresponding lymphatic drainage have been abandoned. The old Halstedian paradigm had been overcome, and conservative treatments, both for the excision of breast tissue and for the surgical approach of the armpit, have been increasingly employed<sup>5,6</sup>.

The theory proposed by Bernard Fisher, which defines breast cancer as a systemic disease, was the basis for the development of breast-conserving surgery, providing a new and much-less aggressive perspective to surgical therapy<sup>7-9</sup>.

Veronesi, author of the renowned *Milan I* study, conducted between 1973 and 1980, analyzed 701 cases of early-stage breast cancer and randomized a group to undergo breast-conserving surgery with radiotherapy and another group with radical mastectomy<sup>10</sup>. After 20 years of follow-up, the author observed that both

<sup>1</sup>Universidade de Caxias do Sul – Caxias do Sul (RS), Brazil.

\*Corresponding author: vanderlei.bertuol@gmail.com

Conflict of interests: nothing to declare.

Received on: 10/07/2019. Accepted on: 12/11/2019.

groups obtained the same long-term survival rates. This study revolutionized breast cancer treatment, making breast-conserving surgery a treatment chosen for early-stage cases<sup>11</sup>.

Nowadays, most patients in stages I and II of the disease are candidates for breast-conserving treatment, which consists of undergoing surgery with partial excision of the mammary gland (sectionectomy or quadrantectomy) followed by radiotherapy<sup>1</sup>. For this surgical decision, tumor size is not an exclusive limiting factor of conservative surgery. The tumor-to-breast volume ratio is the most important anatomical factor. Thus, breast-conserving surgery must always be the first option, provided that there are no contraindications to the procedure and that the tumor-to-breast volume ratio allows a surgical excision with satisfactory cosmetic outcome, according to oncological surgery concepts<sup>12</sup>.

Therefore, it is established that the aim of breast-conserving surgery is to completely remove the tumor with free margins, obtaining a good cosmetic result, but without compromising local recurrence rates<sup>1</sup>.

Prospective, randomized clinical trials have shown that there is no significant difference in distant disease-free survival or overall survival between patients treated with mastectomy and those treated with breast-conserving surgery and radiotherapy. This reinforces the indication of breast-conserving surgery as the best cosmetic alternative for most patients, since it provides the same cure rates without the aggressiveness and mutilation caused by mastectomy<sup>9,11</sup>. However, 4 to 20% of patients with early-stage breast cancer have local recurrence<sup>13</sup>.

The lack of adjuvant radiotherapy and positive surgical margins was associated with an increase in this recurrence<sup>13,14</sup>. In addition, it is known that local recurrence increases the risk of distant recurrence<sup>15,16</sup>. Compromised surgical margin is the most common indication of reexcision after breast-conserving surgery, and this approach can lead to worse cosmetic results, increased risk of infection, higher costs, and delay in early adjuvant treatment<sup>1</sup>.

There is an intense debate about surgical margins, although the 2010 International Consensus defines positive margin as ink on microscopic tumors in cases of invasive carcinomas and a 2-mm margin for carcinoma *in situ*<sup>16,17</sup>.

Factors, such as tumor biology and the availability of effective systemic therapy, are as important as the margin of microscopic residual disease in determining local control. The standard definition of negative margin as no ink on the tumor has the clear potential to decrease the indication for surgical reexcision, in addition to avoiding large resections that often require additional remodeling surgery of the affected breast and even of the contralateral breast for symmetry purposes<sup>17,18</sup>.

Over the years, the idea that the lower the volume of excised healthy tissue, the greater the probability of incomplete removal of the neoplasm has been promoted. Likewise, there would be a greater probability of local recurrence due to the growth of the

remaining neoplasm. However, the higher the volume of excised breast tissue, the lower the chances of obtaining more satisfactory cosmetic results<sup>12</sup>.

Waljee et al. conducted a study in which they evaluated the aesthetic effect perceived by patients after breast-conserving surgery, and demonstrated that large asymmetries were correlated with depressive symptoms and worsening in the psychosocial functioning and quality of life of these women<sup>19</sup>.

Thus, considering the importance of the theme, the present study aimed to identify possible tendencies toward excision in healthy tissue beyond the ideal for oncological safety. The results observed here can be used to produce recommendations regarding the volume of tissue to be excised, aiming at cosmesis and aesthetics without impairing the oncological conduct for breast surgeries.

## METHODS

This is a cross-sectional and retrospective study conducted at the Mastology Center of Hospital Geral de Caxias do Sul, in the state of Rio Grande do Sul, Brazil. The medical records of all patients who underwent breast-conserving surgery at the institution, from January 2010 to December 2016, were analyzed.

Eligibility criteria were considered for patients who underwent breast-conserving surgery (sectionectomy or quadrantectomy) and who had a diagnosis of cancer at the time of surgery or cases already confirmed prior to the procedure (prior biopsy).

Data on incomplete or dubious medical records, multicentric/multifocal tumors, and patients submitted to surgical reintervention to enlarge margins were deemed reasons for exclusion from the study.

Data were compiled and evaluated after surveying medical records by research members. The following categories were analyzed: age; menopausal status; tumor size on ultrasonography; tumor size on anatomopathological examination; size of the excised surgical specimen; excised healthy tissue; free or not surgical margin; number of compromised axillary lymph nodes; chemotherapy; tumor location; and histological and molecular characteristics.

Due to the heterogeneity of information in the medical records, the tumor size for the anteroposterior diameter in ultrasound and anatomopathological examination and the size of the excised tissue were considered for comparison purposes.

For patients undergoing neoadjuvant chemotherapy, the residual tumor size after chemotherapy treatment was taken into account.

In the analysis of surgical margin, the disease-free surgical margin was established as no ink on the tumor in cases of invasive tumors and margins greater than 2 mm in cases of tumors *in situ*.

## Data analysis

For statistical purposes, means, standard deviations, Student's t-test, and linear regression for numerical variables were used.

A risk estimate was carried out by odds ratio (OR) through logistic regression with a 95% confidence interval (95%CI). Significance level (alpha) of 5% was adopted.

The database was submitted to a double-entry process with inconsistency processing. Moreover, multivariate backward linear logistic regression was used, associating the new variable with those previously reported. P-value < 0.05 was deemed statistically significant. Analyses were performed using R 3.1.1 for Windows (R-Cran project), with the MASS package for Windows.

The study was submitted to and approved by the Research Ethics Committee of Universidade de Caxias do Sul (UCS).

## RESULTS

Of the total of 194 breast-conserving surgeries performed from January 2010 to December 2016, and according to the inclusion and exclusion criteria, 124 patients remained in the study. The other cases were excluded due to reexcisions, subsequent surgeries related to margin enlargement and multicentric or multifocal tumors, and those related to incomplete hospital data.

Table 1 summarizes the characteristics and results obtained in the present study. In the study group,  $56.9 \pm 11.7$  was the mean

**Table 1.** Clinical and demographic characteristics of patients included in the study (n = 124).

Characteristic	Value	N	(%)
Menopausal status	Premenopausal	33	26.6
	Postmenopausal	91	73.4
Axillary status	Negative	92	74.2
	1–3 positive	24	19.3
	> 4 positive	8	6.5
Histological type	NST	70 cases	56.5
	NST + DCIS	18 cases	14.5
	Special subtypes	14	11.3
	DCIS	DCIS	10.5
	10.5	5	4
	Other types	4	3.2
Immunohistochemistry	Luminal A	56	45
	Luminal B	48	39
	HER2	11	8.8
	Triple-negative	7	5.6
	No tests	2	1.6
Characteristic	Value (mean with SD)		
Age	$56.9 \pm 11.7$ years		
Tumor size in US	$1.7 \pm 0.95$ cm		
Tumor size in AP	$1.9 \pm 1.12$ cm		
Size of the surgical specimen	$7.8 \pm 3.4$ cm		

US: ultrasound; AP: anatomopathological examination; NST: invasive ductal carcinoma (of no special type); DCIS: ductal carcinoma *in situ*; ILC: invasive lobular carcinoma; HER2: human epidermal growth factor receptor 2; SD: standard deviation.

age in years. Considering menopausal status, 33 patients (26.6%) accounted for premenopausal status, and 91 of them (73.4%) accounted for postmenopausal status at the time of diagnosis.

Regarding the axillary status, 92 patients (74.2%) had negative axillary lymph nodes, 24 (19.3%) had 1-3 lymph nodes compromised by neoplasia, and 8 (6.5%) had more than four affected lymph nodes.

It was identified that 59 patients did not undergo chemotherapy. Of the 65 patients who did it, 48 were adjuvant and 17 were neoadjuvant.

Regarding the pathological characteristics of the tumors, 70 cases (56.5%) were of no special type (invasive ductal); 18 (14.5%) had invasive ductal carcinoma and concomitant *in situ*; 14 cases (11.3%) were of special subtypes (e.g., tubular, medullary, mucinous, papillary, etc.); 13 (10.5%), ductal carcinoma *in situ*; and 5 cases (4%) of invasive lobular carcinoma. Four (3.2%) tumors exhibited histological types other than those aforementioned.

As for molecular classification by immunohistochemistry, 56 tumors (45%) were of the type Luminal A; 48 (39%), Luminal B; 11 (8.8%), human epidermal growth factor receptor 2 (HER2); and 7 (5.6%), triple-negative breast cancer. In two cases, immunohistochemistry was not performed because they were non-epithelial tumors (1.6%).

In Table 2 and Graph 1, one may observe the distribution of tumors regarding the location in the breast and the mean of excised tissue. There was no statistical difference regarding tumor location and neither concerning the size of excised tissue in the surgical specimen.

The mean tumor size observed by ultrasonography was  $1.7 \pm 0.95$  cm. The tumor size in the anatomopathological examination was  $1.9 \pm 1.12$  cm. Conversely, the mean size of the excised surgical specimens was  $7.8 \pm 3.4$  cm.

Table 3 and Graph 2 show the amount of excised tissue according to tumor size (in the anatomopathological examination). When comparing groups 1, 2, and 3 with group 4, there was an increase in the resected tissue in group 4 with statistical difference ( $p < 0.01$ ).

When comparing the tumor size in the anatomopathological examination and the size in ultrasonography, the mean differences accounted for 0.6 cm (95%CI -0.10–0.44;  $p = 0.2$ ).

**Table 2.** Location of tumors and mean excised tissue.

Quadrants	N (%)	Excised size	95%CI
UOQ + JUQ	70 (56.5)	8.1 cm	7.5–9
LOQ + JOQ	21 (16.9)	6.7 cm	5.5–8.2
UIQ + JIQ	13 (10.5)	6.3 cm	4.5–8.2
LIQ + JLQ	17 (13.7)	8.4 cm	7–10.2
RA	3 (2.4)	5.6 cm	1.8–9.5

UOQ + JUQ: upper outer quadrant + junction of the upper quadrants; LOQ + JOQ: lower outer quadrant + junction of the outer quadrants; UIQ + JIQ: upper inner quadrant + junction of the inner quadrants; LIQ + JLQ: lower inner quadrant + junction of the lower quadrants; RA: retroareolar region; 95%CI: 95% confidence interval.

On the other hand, the ratio between the size of the total surgical specimen and the tumor size in the anatomopathological examination accounted for 5.8 cm (95%CI 5.2–6.5;  $p < 0.001$ ).

In all cases, free surgical margins were obtained, as established by the literature.

## DISCUSSION

Breast cancer is relatively rare before the age of 35, and its incidence progressively increases above this age, especially after 50 years of age<sup>2</sup>. The age group of patients in our study ranged from 27 to 77 years (mean of  $56.7 \pm 11.7$  years), and most (73.4%) were postmenopausal.

The development and evolution of the sentinel-lymph-node biopsy have positively affected the treatment of early-stage breast cancer. This procedure provides accurate diagnosis and prognostic information on patients with clinically negative lymph nodes and consists of a primary tool to guide surgical and adjuvant treatment. In many cases, sentinel-lymph-node biopsy has

replaced axillary dissection, and patients were spared of lymphedema and additional morbidity attributed to this procedure, thus improving their quality of life<sup>20</sup>.

In the present research, 92 patients (74.2%) had negative axillary lymph nodes; 24 (19.3%) had 1-3 lymph nodes compromised by neoplasia; and only 8 (6.5%) had more than four affected lymph nodes. Since this study only analyzed breast-conserving surgeries and, therefore, patients with early-stage cancer, most patients did not present lymph node metastases.

Veronesi et al. analyzed patients with tumors  $< 2$ -cm who were submitted to sentinel-lymph-node investigation, and found that 65% of them presented negative lymph nodes at the time of the surgery<sup>21</sup>.

A Korean study, whose authors analyzed 945 patients with breast cancer in stages I and II, showed that the molecular subtype is a prognostic factor as important as the compromise of lymph nodes<sup>22</sup>. In this same study, the most frequent subtypes, in order, were Luminal A (41%), Luminal B (29.1%), triple-negative (21.6%), and HER2 (8.3%). In our study, Luminal A and Luminal B were also the majority, but there were more cases of HER2 than triple-negative.

Invasive ductal carcinoma of no special type is the most common histological type, corresponding to 40–75% of breast carcinomas, depending on the series evaluated, and invasive lobular carcinoma accounts for 5–15% of invasive carcinomas<sup>23</sup>. The findings of this research showed that the invasive ductal carcinoma of no special type corresponded to 56.5% of cases, and the invasive lobular corresponded to 4%, corroborating data presented in other studies.

The authors identified 70 cases (56.6%) of tumors located in the upper outer quadrant or junction of the upper quadrants, which are quadrants where there is a higher volume of breast

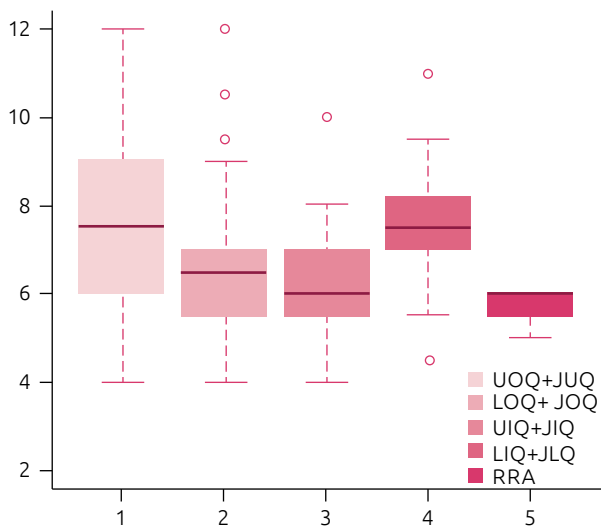

**Graphic 1.** Size of the surgical specimen *versus* tumor location. UOQ + JUQ: upper outer quadrant + junction of the upper quadrants; LOQ + JOQ: lower outer quadrant + junction of the outer quadrants; UIQ + JIQ: upper inner quadrant + junction of the inner quadrants; LIQ + JLQ: lower inner quadrant + junction of the lower quadrants; RA: retroareolar region.

**Table 3.** Tumor size *versus* excised tissue size.

Group	Tumor size	Excised size (mean)
1	< 1 cm	7.2 cm $\pm$ 0.55
2	1 to 2 cm	6.94 cm $\pm$ 0.71
3	> 2–3 cm	7.83 cm $\pm$ 0.81
4	> 3 cm	11.42 cm $\pm$ 1.0

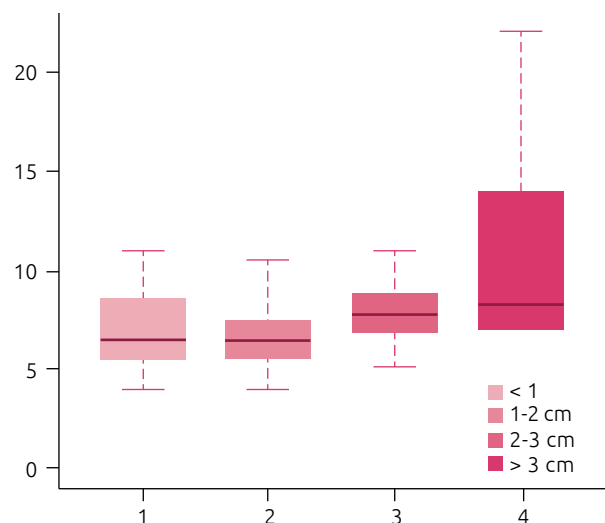

**Graphic 2.** Size of surgical specimen *versus* tumor size.



tissue and, therefore, are more likely to develop the neoplasm. There was no statistical difference regarding tumor location and neither concerning the size of excised tissue in the surgical specimen.

The mean tumor size was  $1.9 \pm 1.12$  cm, a result similar to that found in other studies whose authors analyzed patients with early-stage breast cancer<sup>24,25</sup>.

With the increased use of neoadjuvant chemotherapy and breast-conserving surgery, the accuracy of preoperative tumor size assessment has become important for assisting in the therapeutic decision. Tests such as ultrasound, mammography, and magnetic resonance imaging, can be used for this purpose. Studies have shown that ultrasound is better than mammography for estimating tumor size<sup>26</sup>. When comparing ultrasound and mammography with magnetic resonance imaging, the latter is the most accurate method<sup>27</sup>. When comparing tumor size in anatomopathological examinations and its size in ultrasonography, the mean difference of 0.6 cm (95%CI -0.10–0.44;  $p = 0.2$ ) was identified.

Authors of other studies have also observed differences, such as Shoma et al., who compared the evaluation of tumor size by physical examination, mammography, and ultrasound and found a mean difference of  $3.2 \pm 0.4$  mm<sup>28</sup> in size between ultrasound and anatomopathological examination.

It is clearly perceived that larger tumors dictate techniques that ultimately excise a greater amount of healthy tissue. When comparing groups 1, 2, and 3 with group 4, there was an increase in the size of excised tissue in group 4, with statistical difference ( $p < 0.01$ ). This shows the clear tendency of surgeons for being more aggressive, even in conserving surgeries, when operating tumors whose mean diameter is greater than 3 cm.

The tumor-to-breast volume ratio does not become an absolute contraindication to breast-conserving surgery, provided that it is possible to excise the tumor area, maintaining oncological safety, and causing no large asymmetries<sup>12</sup>. Taking this into consideration, patients with large tumors and small breasts are not likely to be submitted to breast-conserving surgery. Conversely, patients with more voluminous breasts consequently allow for greater tissue resection without major aesthetic impairments, which may justify our findings.

The difference in the size of the total surgical specimen and the tumor size in the anatomopathological examination accounted for 5.8 cm (95%CI 5.2–6.5;  $p < 0.001$ ). When performing simple linear regression, it was observed that every 1 cm of tumor in the anatomopathological examination corresponds to 6.7 cm of surgical tissue.

This finding demonstrates that excessive and unnecessary healthy tissue is being excised in order to obtain a disease-free surgical margin. One possible reason for explaining excessive

resection is the attempt to avoid subjecting the patient to a new surgical procedure to enlarge the margins, thus delaying the onset of adjuvant therapy.

The need to obtain disease-free surgical margins is due to the fact that this is the most important factor in reducing the risk of local recurrence<sup>29</sup>. It is known that  $\frac{1}{4}$  of patients undergoing breast-conserving surgery will require a new surgical procedure for margin enlargement<sup>30</sup>. The use of frozen section histology assists in identifying margins compromised during the intraoperative period, avoiding excessive tissue excision or other surgery, providing more comfort and agility to the surgeons, since they will have information on enlargement of margins in appropriate time for doing it so, which also enhances the chances for surgeries seeking to conserve more healthy tissues.

Nevertheless, this evaluation technique is not a standard procedure in all services, and some authors suggest that the tool may alter the pathological staging and is contraindicated in some cases, such as in small tumors. In addition, the definition of complete excision of the tumor with safety margins is only provided after a histological study of the surgical specimen embedded in paraffin<sup>12</sup>.

Another reason that could explain excessive excision of healthy tissue is the fact that patients with large breasts have greater possibility of wide resection with minor aesthetic defects; however, the purpose of this study was not to evaluate the preoperative breast volume.

## CONCLUSION

It was observed there is a tendency toward excising a large amount of healthy tissue in breast-conserving surgeries, far beyond what is recommended in order to consider the oncological safety of excised margins. The excessive excision of healthy tissue found in this study can bring severe deformities to the breast. An unfavorable aesthetic result may generate emotional impairment and compromise the patients' quality of life, thus opposing the main objective of breast-conserving surgery, which is to maintain cosmesis without harming the oncological conduct.

## AUTHORS' CONTRIBUTIONS

G.P.: Conceptualization, Data curations, Formal analysis, Funding acquisition, Investigation, Methodology, Project administration, Resources, Software, Supervision, Validation, Visualization, Writing - original draft, Writing - review & editing.

F.V.: Conceptualization, Funding acquisition, Methodology, Project administration, Supervision, Validation, Writing - review & editing.

V. B.: Data curation, Investigation, Visualization.

J. P.: Data curation, Investigation, Visualization.

## REFERENCES

- Silva JME, Marinho FMB, Tonello F, Giola SM, Monteiro SO, Bello MA, et al. Margens cirúrgicas no tratamento conservador do câncer de mama: revisão sistemática. 2014;24(3):70-5. <http://dx.doi.org/10.5327/Z201400030003RBM>
- Instituto Nacional de Câncer José Alencar Gomes da Silva. Estimativas câncer de mama. Brasil: Ministerio da Saúde; 2016.
- Caxias do Sul. Secretaria Municipal da Saúde. Óbitos por Neoplasias de Residentes de Caxias do Sul. Caxias do Sul: Secretaria Municipal da Saúde; 2016.
- Luini A, Gatti G, Galimberti V, Zurrada S, Intra M, Gentilini O, et al. Conservative treatment of breast cancer: its evolution. *Breast Cancer Res Treat.* 2005;94(3):195-8. <https://doi.org/10.1007/s10549-004-7376-0>
- Halsted WSI. The Results of Radical Operations for the Cure of Carcinoma of the Breast. *Ann Surg.* 1907;46(1):1-19. <https://dx.doi.org/10.1097%2F00000658-190707000-00001>
- Halsted WSI. The Results of Operations for the Cure of Cancer of the Breast Performed at the Johns Hopkins Hospital from June, 1889, to January, 1894. *Ann Surg.* 1894;20(5):497-555. <https://dx.doi.org/10.1097%2F00000658-189407000-00075>
- Fisher B. Biological and clinical considerations regarding the use of surgery and chemotherapy in the treatment of primary breast cancer. *Cancer.* 1977;40(1 Supl.):574-87. [https://doi.org/10.1002/1097-0142\(197707\)40:1+%3C574::aid-cncr2820400724%3E3.0.co;2-o](https://doi.org/10.1002/1097-0142(197707)40:1+%3C574::aid-cncr2820400724%3E3.0.co;2-o)
- Fisher B, Jeong JH, Anderson S, Bryant J, Fisher ER, Wolmark N. Twenty-five-year follow-up of a randomized trial comparing radical mastectomy, total mastectomy, and total mastectomy followed by irradiation. *N Engl J Med.* 2002;347(8):567-75. <https://doi.org/10.1056/NEJMoa020128>
- Fisher B, Anderson S, Bryant J, Margolese RG, Deutsch M, Fisher ER, et al. Twenty-year follow-up of a randomized trial comparing total mastectomy, lumpectomy, and lumpectomy plus irradiation for the treatment of invasive breast cancer. *N Engl J Med.* 2002;347(16):1233-41. <https://doi.org/10.1056/NEJMoa022152>
- Veronesi U, Saccozzi R, Del Vecchio M, Banfi A, Clemente C, De Lena M, et al. Comparing radical mastectomy with quadrantectomy, axillary dissection, and radiotherapy in patients with small cancers of the breast. *N Engl J Med.* 1981;305(1):6-11. <https://doi.org/10.1056/NEJM198107023050102>
- Veronesi U, Cascinelli N, Mariani L, Greco M, Saccozzi R, Luini A, et al. Twenty-year follow-up of a randomized study comparing breast-conserving surgery with radical mastectomy for early breast cancer. *N Engl J Med.* 2002;347(16):1227-32. <https://doi.org/10.1056/NEJMoa020989>
- Tiezzi DG. Cirurgia conservadora no câncer de mama: Rev Bras Ginecol Obstet. 2007;29(8):428-34. <http://dx.doi.org/10.1590/S0100-72032007000800008>
- Gage I, Schnitt SJ, Nixon AJ, Silver B, Recht A, Troyan SL, et al. Pathologic margin involvement and the risk of recurrence in patients treated with breast-conserving therapy. *Cancer.* 1996;78(9):1921-8. [https://doi.org/10.1002/\(sici\)1097-0142\(19961101\)78:9%3C1921::aid-cncr12%3E3.0.co;2-#](https://doi.org/10.1002/(sici)1097-0142(19961101)78:9%3C1921::aid-cncr12%3E3.0.co;2-#)
- Mirza NQ, Vlastos G, Meric F, Buchholz TA, Esnaola N, Singletary SE, et al. Predictors of locoregional recurrence among patients with early-stage breast cancer treated with breast-conserving therapy. *Ann Surg Oncol.* 2002;9(3):256-65. <https://doi.org/10.1007/bf02573063>
- Vicini FA, Kestin L, Huang R, Martinez A. Does local recurrence affect the rate of distant metastases and survival in patients with early-stage breast carcinoma treated with breast-conserving therapy? *Cancer.* 2003;97(4):910-9. <https://doi.org/10.1002/cncr.11143>
- Kaufmann M, Morrow M, Von Minckwitz G, Harris JR. Locoregional treatment of primary breast cancer: consensus recommendations from an International Expert Panel. *Cancer.* 2010;116(5):1184-91. <https://doi.org/10.1002/cncr.24874>
- Houssami N, Morrow M. Margins in breast conservation: a clinician's perspective and what the literature tells us. *J Surg Oncol.* 2014;110(1):2-7. <https://doi.org/10.1002/jso.23594>
- Moran MS, Schnitt SJ, Giuliano AE, Harris JR, Khan SA, Horton J, et al. Society of Surgical Oncology-American Society for Radiation Oncology consensus guideline on margins for breast-conserving surgery with whole-breast irradiation in stages I and II invasive breast cancer. *Int J Radiat Oncol Biol Phys.* 2014;88(3):553-64. <https://doi.org/10.1016/j.ijrobp.2013.11.012>
- Waljee JF, Hu ES, Ubel PA, Smith DM, Newman LA, Aldeman AK. Effect of esthetic outcome after breast-conserving surgery on psychosocial functioning and quality of life. *J Clin Oncol.* 2008;26(20):3331-7. <https://doi.org/10.1200/JCO.2007.13.1375>
- Valero MG, Golshan M. Management of the Axilla in Early Breast Cancer. *Cancer Treat Res.* 2018;173:39-52. [https://doi.org/10.1007/978-3-319-70197-4\\_4](https://doi.org/10.1007/978-3-319-70197-4_4)
- Veronesi U, Paganelli G, Viale G, Luini A, Zurrada S, Galimberti V, et al. Sentinel-lymph-node biopsy as a staging procedure in breast cancer: update of a randomised controlled study. *Lancet Oncol.* 2006;7(12):983-90. [https://doi.org/10.1016/S1470-2045\(06\)70947-0](https://doi.org/10.1016/S1470-2045(06)70947-0)
- Kim H, Cho J, Kwon SY, Kang SH. Biologic subtype is a more important prognostic factor than nodal involvement in patients with stages I and II breast carcinoma. *Ann Surg Treat Res.* 2016;90(1):1-9. <https://doi.org/10.4174/ast.2016.90.1.1>
- Van Bogaert, L. J. Recent progress in the histological typing of human breast tumours. *Diagn Histopathol.* 1981;4(4):349-53.
- Gurleyik G, Karagulle H, Eris E, Aker F, Ustaalioglu BO. Oncoplastic surgery; volume displacement techniques for breast conserving surgery in patients with breast cancer. *Acta Chir Belg.* 2017;117(3):169-75. <https://doi.org/10.1080/00015458.2016.1272916>
- Kondov B, Isijanovska R, Milenkovicj Z, Petruveska G, Jovanovski-Srceva M, Bogdanovska-Todorovska M. et al. Impact of Size of the Tumour, Persistence of Estrogen Receptors, Progesterone Receptors, HER2Neu Receptors and Ki67 Values on Positivity of Axillary Lymph Nodes in Patients with Early Breast Cancer with Clinically Negative Axillary Examination. *Open Access Maced J Med Sci.* 2017;5(7):825-30. <https://doi.org/10.3889/oamjms.2017.213>

26. Hieken TJ, Harrison J, Herreros J, Velasco JM. Correlating sonography, mammography, and pathology in the assessment of breast cancer size. *Am J Surg.* 2001;182(4):351-4. [https://doi.org/10.1016/s0002-9610\(01\)00726-7](https://doi.org/10.1016/s0002-9610(01)00726-7)
27. Davis PL, Staiger MJ, Harris KB, Ganott MA, Klementaviciene J, McCarty KS Jr., et al. Breast cancer measurements with magnetic resonance imaging, ultrasonography, and mammography. *Breast Cancer Res Treat.* 1996;37(1):1-9. <https://doi.org/10.1007/bf01806626>
28. Shoma A, Moutamed A, Ameen M, Abdelwahab A. Ultrasound for accurate measurement of invasive breast cancer tumor size. *Breast J.* 2006;12(3):252-6. <https://doi.org/10.1111/j.1075-122X.2006.00249.x>
29. DiBiase SJ, Komarnicky LT, Schwartz GF, Xie Y, Mansfield CM. The number of positive margins influences the outcome of women treated with breast preservation for early stage breast carcinoma. *Cancer.* 1998;82(11):2212-20.
30. Butler-Henderson K, Lee AH, Price RI, Waring K. Intraoperative assessment of margins in breast conserving therapy: a systematic review. *Breast.* 2014;23(2):112-9. <https://doi.org/10.1016/j.breast.2014.01.002>



# Main prognostic and predictive immunohistochemical factors in breast cancer: a retrospective cohort study

Diogo Ferreira Ducatti<sup>1\*</sup> , Cláudio Galleano Zettler<sup>1</sup> 

## ABSTRACT

**Introduction:** Breast cancer is a constant focus of studies on prevention and treatment. Immunohistochemistry is a useful tool for defining the conducts toward the treatment of this disease. **Objective:** To evaluate patients' survival according to prognostic and predictive immunohistochemical factors. **Method:** This is a retrospective cohort study. Medical reports of 787 patients were analyzed, which contained parts of surgical specimens of the mastectomy or quadrantectomy procedures. A total of 404 patients were eligible for the study. **Results:** The mean age at diagnosis of the disease was 55.4 years. The main diagnosis was infiltrating ductal carcinoma (80.7%). Of the total, 45% of the patients had tumors of up to 2 cm in diameter, and 32.9% had lymph node involvement. Among the patients, and according to luminal molecular classification, 48.3% were classified as luminal A, 27% were luminal B, 12.1% were recipient of human epidermal growth factor type 2 (HER2), and 12.6% were triple-negative. Furthermore, of 23.3% patients with tumor recurrence, 12.6% of them died. The 1% increase in Ki-67 values increases the risk of death and recurrence by 2% and 1%, respectively. The presence of lymph node metastasis increases, on average, 4.78 times and 2.63 times the risk of death and recurrence, respectively. **Conclusion:** The triple negative molecular classification had the lowest overall survival and the greatest risk of recurrence. The luminal A classification presented the best prognosis. Tumor size, lymph node metastasis, skin invasion, and presence of Ki-67 were shown to be the prognostic and predictive factors that most influenced the patients' survival.

**KEYWORDS:** breast cancer; immunohistochemistry; prognosis; survival; recurrence.

## INTRODUCTION

Breast cancer is the most common malignant neoplasm found in Southern Brazil, with the exception of non-melanoma skin cancer. In 2018 alone, there were 56.33 cases per 100,000 women, which corresponds to more than 20% of all types of cancer<sup>1</sup>.

Breast cancer is the leading cause of death among women worldwide, accounting for 522,000 deaths in 2012 alone, equivalent to 14.7% of all deaths in that year. The incidence of breast cancer has virtually increased worldwide, but in developed countries, this number has decreased in the last 10 years. Moreover, there has been a reduction in the death rate related to breast cancer due to adequate screening, early detection, and effective therapy<sup>2</sup>.

Breast neoplasm does not indicate clinical uniformity and is characterized according to the morphology of the disease, thus existing different molecular forms and subtypes. Instead, it should be stated that breast cancer consists of a range of distinct

neoplasms, which are all classified as breast cancer. These varied forms of the disease enable the evaluation and development of prognosis based on their evolution, making it possible to prescribe specific treatments according to the development and characteristics of each type. Acknowledging this is important due to the need for defining the prognosis and the appropriate approach, aiming at avoiding to unnecessarily submit patients to aggressive treatments such as chemotherapy<sup>3</sup>.

Immunohistochemical examination and anatomopathological analysis are paramount to define the disease approach and the prognosis of the patient. Immunohistochemistry is a technique used to identify biological characteristics of tumors, including breast-related ones. Molecular technology with biomarkers allows identifying and classifying breast cancer into different subtypes that, consequently, exhibit different behaviors. Biomarkers are often used for determining the best therapy to be provided and

<sup>1</sup>Universidade Federal de Ciências da Saúde de Porto Alegre – Porto Alegre (RS), Brazil.

\*Corresponding author: diogoducatti@hotmail.com

Conflict of interest: nothing to declare.

Received on: 10/16/2019. Accepted on: 12/25/2019

for other decisions concerning treatment approaches, including the confirmation of metastases. This technology has proved to be an important diagnosis tool, since it is a simple, practical, and versatile instrument<sup>4</sup>.

## PROGNOSTIC FACTORS

Prognostic factors consist of aspects that may interfere with the clinical evolution of the disease at the time of diagnosis. The main parameters for determining the therapeutic planning of breast cancer are age, tumor size, lymph node involvement, and molecular subtype<sup>5</sup>.

Age is among the three main prognostic factors that are prominent when it comes to survival in breast cancer. It carries a considerable weight to decisions to be made at two moments during the course of the disease: first, at diagnosis and, secondly, at the definition of the treatment to be provided, being older age directly related to the worst outcome of breast cancer.<sup>6</sup> Older women and those in menopause have fewer recurrences and deaths from breast cancer, usually because they feature less aggressive molecular classification, though they are affected by age-related issues, and the presence of aging-related comorbidities, which limit therapies or their responses, are common. Conversely, younger women develop larger tumors, high histologic grade, increased vascular invasion, and lymph node involvement, even when submitted to more aggressive treatments<sup>7-9</sup>.

Tumor size has key importance in the survival of breast cancer patients. Survival is proportionally inferior to tumor size. That is, tumors with larger diameters are associated with lymph node involvement, higher mortality, and lower disease-free survival<sup>8-12</sup>.

Breast tumors manifest responses to the provided therapies and disease evolution in a very varied way. This is because breast tumors have complex genome variation. These variations allow such tumors to present very different evolutions and biological behaviors, although they are all classified as breast cancer. Molecular classification allows identifying, with a high degree of accuracy, different types of the disease based on profiles. Thus, if a metastasis, whether distant or in a lymph node, is related to a certain tumor, it will present the same pattern of genes as if it were a sample of the main tumor<sup>13</sup>.

## PREDICTIVE FACTORS

Lymph node involvement is the predictive factor that mostly influences therapeutic approaches. Based on this involvement, the breast volume that will be exposed to radiation in radiotherapy treatment can determine, in addition to whether there shall be lymph node clearance of the axillary region, which can cause important side and aesthetic effects on the quality of life of patients under treatment<sup>14</sup>. This factor greatly influences the outcome of breast cancer, especially when there is involvement

of axillary lymph nodes, since they have a strong impact on overall survival and disease-free survival in a 10-year period<sup>8,9</sup>. Lymph node involvement indicates that, in addition to breast cancer being aggressive, it is already in a dimension that will interfere with disease-free and overall survival rates, regardless of the provided therapy<sup>15</sup>.

Hence, lymph node invasion is a predictive factor for metastatic dissemination of breast cancer, contributing to a worsened evolution of the disease<sup>16</sup>.

The most commonly used biomarkers in determining the treatment for breast cancer are estrogen and progesterone hormone receptors<sup>17</sup>.

The human epidermal growth factor receptor type 2 (HER2) performs specific functions of cell differentiation, regulation, and proliferation. Its overexpression occurs in 15% of breast tumors. Mostly, it features negative hormone receptors and is related to a more aggressive type of the disease and worse prognosis. Its advantage is the current existence of target molecular therapy for tumors manifesting this overexpressed factor<sup>18,19</sup>.

The Ki-67 proliferation index indicates cell multiplication. It is present in all active phases of the cell cycle, with the exception of the G0 phase<sup>20</sup>, being routinely evaluated in immunohistochemical tests for breast cancer as it is responsible for the differentiation between tumors of luminal types A and B. Ki-67 is directly associated with tumor aggressiveness and poor prognosis<sup>21</sup>. It represents high histologic grade and high speed of tumor growth, providing reliable, easy-to-analyze, and low-cost information, being paramount for determining the clinical conduct<sup>22</sup>.

Breast tumor cells have many structural differences, even when they are very similar according to microscope images. Immunophenotyping allowed the creation of gene expression profiling, which can be used to identify tumor evolution based on its molecular phenotype<sup>7</sup>.

The aim of this study was to compare the main pathological prognostic and predictive factors with the outcome of patients who underwent treatments for breast carcinoma. Disease-free survival time was related to prognostic factors of tumor size, age, and lymph node involvement; in addition, disease-free survival time according to predictive factors of molecular classification by immunophenotyping were evaluated.

## METHODOLOGY

A survey on all female patients who had their surgical specimens of breast carcinoma analyzed in the Pathology Laboratory of *Hospital Santa Rita da Irmandade da Santa-Casa de Misericórdia de Porto Alegre* (ISCMPA), from 2008 to 2012, was performed. Then, each of the medical reports were read, leading to the selection of those in which the specimens derived from a surgical procedure of mastectomy or quadrantectomy. Each of the medical reports was cataloged and transformed into a number, aiming to ensure the

patients' anonymity. Date of diagnosis, age of the patient, size of the surgical specimen, tumor grade, immunohistochemical classification, surgical margins, lymph node involvement, presence of carcinoma *in situ*, date of recurrence (when is the case), and date of the last follow-up were used to import data into a spreadsheet in the Excel computer program® for the analysis.

In some cases, there were divergences between the immunohistochemical classification of the biopsy and the subsequent analysis of the surgical specimen. This is due to biopsies being performed on a small portion of the tumor. On the other hand, the surgical specimen is analyzed in the so-called "hot spot," where the highest concentration of tumor cells is found. Since it is deemed the most reliable analysis, a real classification was considered as that performed after the analysis of the specimen by the Pathology Laboratory. The deadline for updating each patient's outcome was December 31<sup>st</sup>, 2018.

Death was measured and validated in the study only when it occurred within the institution and it was recorded in the electronic medical reports of each patient.

Patients who had undergone any procedure other than mastectomy or quadrantectomy, those with a history of previous neoplasms, or whose pathological examinations proved the emergence of new primary lesions were excluded from the study.

We followed the ethical precepts of Resolution No. 466/2012 of the National Health Council (*Conselho Nacional de Saúde* – CNS), respecting the confidentiality of the participating subjects. Data were anonymously managed, without any nominal identification or other information that allowed identifying the participants.

The project was approved by the Research Ethics Committee of ISCMPA, under Opinion no. 2.324.152.

## STATISTICAL ANALYSIS

Quantitative variables were described by mean and standard deviation or by median and interquartile range, and categorical variables, by absolute and relative frequencies (Table 1).

Overall survival and disease-free survival curves were estimated by the Kaplan-Meier method<sup>22</sup> (Figures 1 and 2). To evaluate factors associated with outcomes, the univariate and the multivariate Cox proportional hazards regression models<sup>23</sup> were applied (Table 2). All variables that presented  $p < 0.20$  in the univariate analysis were inserted in the multivariate model (Table 3); in the final model, only variables presenting  $p < 0.10$  remained.

The adopted significance level was 5%, and analyses were performed in the Statistical Package for the Social Sciences (SPSS) program, version 21.0.

## RESULTS

In total, the medical reports of 787 patients that comprised immunohistochemical and anatomopathological analyses of

the mastectomy or quadrantectomy procedures were directly analyzed. After applying the eligibility criteria, the reports of 404 patients were eligible for the study. The mean age of the

**Table 1.** Characterization of the sample.

Variables	n=404
Age at diagnosis (years) – mean±SD	55.4±12.3
Current age (years) – mean±SD	61.8±12.6
Diagnosis – n (%)	
Infiltrating ductal carcinoma	326 (80.7)
Infiltrating lobular carcinoma	39 (9.7)
Infiltrating ductal and lobular carcinoma	8 (2.0)
Carcinoma <i>in situ</i>	31 (7.7)
Tumor size – n (%)	
Up to 2 cm in diameter	182 (45.0)
Between 2 and 5 cm in diameter	164 (40.6)
Over 5 cm in diameter	29 (7.2)
Any tumor size with chest wall or skin invasion	29 (7.2)
Histologic grade – n (%)	
G I	55 (13.6)
G II	204 (50.6)
G III	144 (35.7)
Lymph nodes – n (%)	
Lymph node metastasis (S)	133 (32.9)
No lymph node metastasis	271 (67.1)
Type of surgery – n (%)	
Quadrantectomy	284 (70.3)
Mastectomy	120 (29.7)
Skin invasion – n (%)	
Nipple invasion – n (%)	15 (3.7)
Solitary nodule – n (%)	352 (87.1)
Presence of carcinomas <i>in situ</i> – n (%)	
Tumor-free surgical margin – median (P25–P75)	0.3 (0.1–0.8)
Presence of inflammatory infiltrate – n (%)	
Estrogen receptor – median (P25–P75)	90 (62.5–90)
Progesterone receptor – median (P25–P75)	40 (0–80)
HER2>30% – n (%)	50 (12.4)
Ki-67 – median (P25–P75)	10 (5–30)
Molecular classification – n (%)	
Luminal A	195 (48.3)
Luminal B	109 (27.0)
HER2	49 (12.1)
Triple negative	51 (12.6)
Death – n (%)	
Recurrence – n (%)	94 (23.3)

SD: standard deviation; HER2: human epidermal growth factor receptor type 2.

patients at the time of diagnosis was 55.4 years, with a standard deviation of 12.3. The mean age at the end of the analysis of the medical reports, on December 31<sup>st</sup>, 2018, was 61.8 years, with a standard deviation of 12.6. The diagnosis of greatest predominance was infiltrating ductal carcinoma, accounting for an 80.7% occurrence, followed by infiltrating lobular carcinoma, with 9.7%, and carcinoma *in situ*, with 7.7%. Taken together, the presence of ductal carcinoma and lobular carcinoma occurred in 2% of the sample.

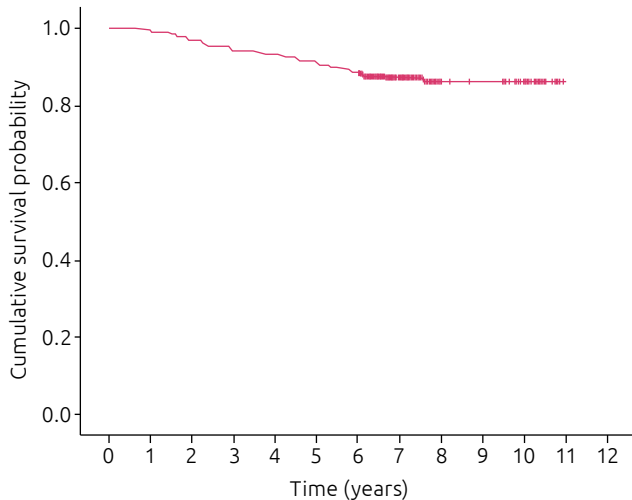

Patients at risk	404	402	393	381	377	368	258	213	83	83	83	83
Survival rate (%)	100	99.5	97.3	94.3	93.3	91.1	88.6	87.4	86.4	86.4	86.4	86.4

Figure 1. Survival curve according to the Kaplan-Meier method.

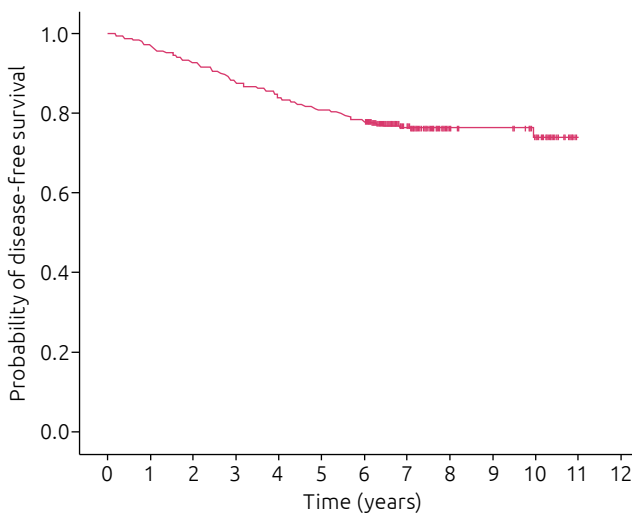

Patients at risk	404	393	374	354	338	325	313	157	157	157	35	35
Event-free survival rate (%)	100	97.3	92.8	87.9	84.1	80.9	77.9	76.8	76.8	76.8	74.2	74.2

Figure 2. Disease-free survival curve according to the Kaplan-Meier method.

Variables with overall survival were associated with virtually all variables, except carcinomas *in situ*, tumor-free surgical margin, inflammatory infiltrate, and HER2. These same variables, in addition to the multinodal variable, were not significantly associated with disease-free survival.

To control confounding factors, the multivariate Cox regression model was performed (Table 3). After adjustment, current age, tumor size, lymph node metastasis, and Ki-67 remained associated with both overall survival and disease-free survival.

Molecular classification showed no significant relevance in the multivariate analysis.

The most frequent tumor size, according to the international classification system validated by the American Joint Committee on Cancer (AJCC) and by the Union for International Cancer Control (UICC), used as a tool in the staging of neoplasms, namely the TNM, was classified as T1, with tumors of up to 2 cm in diameter and occurrence of 45% in the analyses. Tumors between 2 and 5 cm in diameter, classified as T2, corresponded to 40.6% of the sample. Tumors classified as T3 and T4 stages corresponded to the remaining 14.4%. Among tumors classified as T4, the most present invasion was the skin one, with a 5.9% occurrence. Nipple invasion had a frequency of 3.7% of the sample.

According to the histologic grading modified by Elston and Ellis<sup>22</sup>, the most frequent histologic grade was II, with 50.6%, corresponding to moderately differentiated tissues; followed by grade III, with badly differentiated tissues in 35.7% of the sample; and finally grade I, with well-differentiated tissues in 13.6% of the sample. Regarding lymph node involvement, 32.9% of patients presented lymph node metastases.

The use of neoadjuvant chemotherapy and the evolution of adequate staging and surgical techniques enabled to perform much more breast-conserving surgeries in the treatment of breast cancer. Thus, the most frequent surgical procedure in the study was the quadrantectomy, corresponding to 70.3% of the surgical profile identified in the sample. In this profile, the median of 0.3 cm of the surgical margin was maintained. A total of 53.2% of patients presented carcinoma *in situ*. Inflammatory infiltrate was present in 33.7% of the analyses. When there was presence of hormonal receptors, estrogen and progesterone, they represented a median of 90 and 40%, respectively. HER2 $\geq$ 30% occurred in 12.4% of the analyses. The Ki-67 proliferation index had a median of 10%.

The most frequent molecular classification was luminal A (48.3%), followed by luminal B (27%), HER2, and triple-negative (both with 12.6% each). The sample accounted for 12.6% of death and a total of 23.3% of recurrences.

## DISCUSSION

As described in the literature<sup>25</sup>, no statistically positive difference or evidence was found between the outcome of patients

who underwent quadrantectomy instead of mastectomy. In this sense, patients who underwent mastectomies had 2.06 times more deaths and 1.67 times more recurrences than patients treated with breast-conserving surgeries. Surgeries for the treatment of breast cancer have developed in such a way that major mutilating surgeries are being replaced with minimal surgical resections without impacts on the patients' prognosis<sup>11</sup>.

Carcinoma *in situ* showed no statistical significance for the study, nor did the 33.7% of patients with inflammatory infiltrate.

In the univariate Cox regression analysis to evaluate factors, such as overall and disease-free survival rates, almost all factors were significantly associated. The mean age at the time of diagnosis was 55.4 years, which is similar to the mean of 56.8 years reported in other studies<sup>8,9</sup>. According to the regression analysis, age was associated with a 0.95 risk of death or recurrence. According to the univariate analysis, tumors classified as T2 increase the possibility of death by 2.31 times, and the possibility of recurrence by 1.7 times. Tumors with more than 5 cm in diameter, classified as T3, worsen the overall and

**Table 2.** Univariate Cox regression analysis to evaluate factors associated with overall survival and disease-free survival.

Variables	Overall survival		Disease-free survival	
	Hazard ratio (95%CI)	P	Hazard ratio (95%CI)	P
Age at diagnosis (years)	0.97 (0.95–0.99)	0.005	0.97 (0.95–0.99)	0.001
Current age (years)	0.95 (0.92–0.97)	<0.001	0.95 (0.92–0.97)	<0.001
<b>Tumor size</b>				
Up to 2 cm in diameter	1.00	–	1.00	–
Between 2 and 5 cm in diameter	2.31 (1.08–4.93)	0.031	1.70 (1.03–2.81)	0.038
Over 5 cm in diameter	6.61 (2.69–16.3)	<0.001	4.08 (2.10–7.96)	<0.001
Any tumor size with chest wall or skin invasion	9.56 (4.13–22.2)	<0.001	6.55 (3.58–11.9)	<0.001
<b>Histologic grade</b>				
G I / G II	1.00	–	1.00	–
G III	3.27 (1.85–5.78)	<0.001	2.11 (1.41–3.17)	<0.001
<b>Lymph nodes</b>				
Lymph node metastasis (S)	6.81 (3.63–12.8)	<0.001	3.67 (2.43–5.55)	<0.001
No lymph node metastasis	1.00	–	1.00	–
<b>Type of surgery</b>				
Quadrantectomy	1.00	–	1.00	–
Mastectomy	2.06 (1.19–3.57)	0.010	1.67 (1.10–2.53)	0.015
Skin invasion	5.38 (2.76–10.5)	<0.001	4.87 (2.83–8.36)	<0.001
Nipple invasion	5.11 (2.29–11.4)	<0.001	4.49 (2.33–8.68)	<0.001
Multinodular	1.97 (1.01–3.83)	0.047	1.39 (0.80–2.42)	0.242
Presence of carcinomas <i>in situ</i>	1.16 (0.66–2.01)	0.608	1.17 (0.78–1.76)	0.456
Tumor-free surgical margin	0.65 (0.34–1.25)	0.199	0.84 (0.54–1.32)	0.449
Presence of inflammatory infiltrate	1.17 (0.66–2.06)	0.590	1.29 (0.86–1.96)	0.221
Estrogen receptor	0.99 (0.98–0.99)	<0.001	0.99 (0.99–1.00)	0.001
Progesterone receptor	0.98 (0.97–0.99)	<0.001	0.99 (0.99–1.00)	0.011
HER2>30%	1.37 (0.64–2.91)	0.417	1.20 (0.67–2.16)	0.535
Ki-67	1.03 (1.02–1.04)	<0.001	1.02 (1.01–1.03)	<0.001
<b>Molecular classification</b>				
Luminal A	1.00	–	1.00	–
Luminal B	3.23 (1.54–6.79)	0.002	2.01 (1.23–3.26)	0.005
HER2	3.12 (1.26–7.76)	0.014	1.80 (0.95–3.43)	0.073
Triple negative	5.37 (2.41–11.9)	<0.001	2.26 (1.24–4.13)	0.008

95%CI: 95% confidence interval; HER2: human epidermal growth factor receptor type 2.



disease-free survival rates by 6.61 and 4.08 times, respectively, when compared to tumors smaller than 2 cm. Regarding T4 tumors, according to the univariate analysis, these tumors can worsen the overall and disease-free survival rates by 9.56 and 6.55 times, respectively. One fact that reinforces this statement is that skin invasion represented an increase of 5.38 times in the death rate and 4.87 times in the possibility of recurrence. Likewise, as T4 tumors, nipple invasion had a slightly more modest probability, with an increase in the possibility of death by 5.11 times and in the possibility of recurrence by 4.49 times. Tumor size compromises the favorable prognosis in larger lesions (>2 cm), mainly due to the impairment of more than 70% of the local lymphatic system<sup>10,26,27</sup>.

The 1% increase in Ki-67 values raises, on average, by 2% and 1% the risk of death and recurrence, respectively. This factor is inversely proportional to the survival of patients with breast cancer<sup>21</sup>. The increase in Ki-67 is not only related to the proliferation of tumor cells, but also to the proliferation of blood vessels key to tumor growth and the metastasis process, since a neoplasm would not exceed 2–3 mm without a minimally adequate vascular network<sup>10,28</sup>. Tumor cell proliferation is related to prognosis in many tumors. The recognized aggressiveness of tumors classified as luminal B, when compared to luminal A ones, is probably related to Ki-67. It consists of a nuclear antigen present in the active phases of the entire cell cycle, with the exception of the G0 phase (resting phase). Although Ki-67 is essentially recognized for determining prognosis, it cannot be used as a basic criterion, since breast cancer is related to many factors that, together, determine the prognosis of each patient<sup>20</sup>.

Only tumors classified as histologic grade III presented significant values of death or recurrence, accounting for 3.27 and 2.11 times, respectively, which occurs due to the ease of induction to post-chemotherapy cell apoptosis in breast cancer cells of histologic grades I and II<sup>29</sup>.

According to the univariate analysis, the presence of lymph node metastasis increases death probability by 6.81 times and the risk of recurrence by 3.67 times.

Death probability was only statistically higher in triple-negative tumors, with a probability 5.37 times higher for death and 2.26 times higher for recurrence in patients within this classification. Although the triple-negative tumor, in many cases, presents a complete pathological response, this does not translate into better survival<sup>20</sup>. This finding corroborates the statement that triple-negative breast cancer has the worst prognosis, with disease-free survival between 14 and 17.8 months. Its guarded prognosis is closely related to the fact that this grade of breast neoplasia has no specific target therapy<sup>30</sup>.

The luminal B subtype represented the second-worst prognosis in the univariate analysis, with a 3.23 times higher probability of death and a 2.01 times higher probability of recurrence when compared with luminal A — data that negatively outweigh even HER2 tumors, which presented overall survival 3.12 times worse and disease-free survival 1.80 times worse when compared to luminal A. The prognosis of HER2 tumors was better when compared to luminal B. This fact may be related to the treatment provided to HER2 patients, since HER2 tumors demonstrate

**Table 3.** Multivariate Cox regression analysis to evaluate factors associated with overall survival and disease-free survival.

Variables	Overall survival		Disease-free survival	
	Hazard ratio (95%CI)	P	Hazard ratio (95%CI)	P
Current age (years)	0.96 (0.94–0.98)	<0.001	0.96 (0.95–0.98)	<0.001
Tumor size				
Up to 2 cm in diameter	1.00	–	1.00	–
Between 2 and 5 cm in diameter	1.21 (0.54–2.69)	0.642	1.25 (0.74–2.10)	0.410
Over 5 cm in diameter	3.40 (1.32–8.75)	0.011	3.09 (1.53–6.23)	0.002
Any tumor size with chest wall or skin invasion	3.56 (1.41–8.99)	0.007	4.34 (2.25–8.36)	<0.001
Lymph nodes				
Lymph node metastasis (S)	4.11 (2.06–8.21)	<0.001	2.58 (1.64–4.08)	<0.001
No lymph node metastasis	1.00	–	1.00	–
Progesterone receptor	0.99 (0.98–1.00)	0.043	–	–
Ki-67	1.02 (1.01–1.03)	0.002	1.01 (1.00–1.02)	0.008
Molecular classification				
Luminal A	1.00	–	1.00	–
Luminal B	0.90 (0.40–2.02)	0.793	0.81 (0.45–1.45)	0.478
HER2	1.20 (0.44–3.25)	0.722	1.06 (0.53–2.13)	0.865
Triple negative	1.24 (0.44–3.47)	0.679	1.08 (0.50–2.33)	0.843

95%CI: 95% confidence interval; HER2: human epidermal growth factor receptor type 2.

more satisfactory results when aggressive neoadjuvant treatments are administered, which benefit patients classified with this type of breast cancer<sup>29</sup>.

Luminal A classification accounted for the best prognosis, which is probably related to the presence of the progesterone receptor. This receptor presented a positive relationship with a better prognosis, proving to be an independently associated factor, and its increase reduced the risk of death by 1%. This corroborates the results of recent studies whose authors report the association of prognoses significantly favorable to tumors with positive estrogen receptors<sup>10,28,30</sup>.

In the multivariate analysis, no statistical relevance was found in the molecular classification.

Moreover, in this analysis, the one-year increase in age reduces the probability of death or recurrence, on average, by 4%. Death within a 10-year period is directly related to the presence of two factors: lymph node involvement and the age group of 60 years old or older<sup>9</sup>.

Tumors of more than 5 cm in diameter and classified as T3, when analyzed in the multivariate analysis, increase the risk of death or recurrence by 3.5 times.

According to the same analysis, the presence of metastasis in lymph nodes increases the risk of death and recurrence by 4.78 and 2.63 times, respectively, differing from what is reported in the literature<sup>10</sup>.

## CONCLUSION

According to the molecular classification, among the predictive factors, the triple-negative tumor has the worst overall survival and the highest risk of recurrence, and luminal A classification presents the best survival. The increased presence of Ki-67 proved to be a reference factor for worse prognosis. Luminal B molecular classification accounted for the second worst prognosis, surpassing HER2 tumors. Among prognostic factors, tumor size, lymph node metastasis, and skin invasion were deemed reference factors for worse prognosis and lower overall and disease-free survival rates. Further studies and investigation of new markers are required in order to contribute to determining even more reliable prognoses.

## AUTHORS' CONTRIBUTION

D. D.: Conceptualization, Data curation, Formal analysis, Funding acquisition, Investigation, Methodology, Project administration, Software, Visualization, Writing – original draft, Writing – review and editing.

C. Z.: Conceptualization, Investigation, Methodology, Project administration, Resources, Validation, Supervision, Writing – review and editing.







## REFERENCES

1. Instituto Nacional de Câncer José Alencar Gomes da Silva. Estatísticas do câncer [Internet]. Rio de Janeiro: INCA; 2019 [acessado em 15 jan. 2019]. Disponível em: <https://www.inca.gov.br/numeros-de-cancer>
2. Stewart BW, Wild CP. World Cancer Report. 2014. v. 3. p. 16-54.
3. Tavassoli FA. Challenges in breast pathology: new twists on old problems. Arch Pathol Lab Med. 2009;133(6):852-4. <https://doi.org/10.1043/1543-2165-133.6.852>
4. Zaha DC. Significance of immunohistochemistry in breast cancer. World J Clin Oncol. 2014;5(3):382-92. <https://dx.doi.org/10.5306%2Fwjco.v5.i3.382>
5. Freitas Junior R, Nunes RD, Martins E, Curado MP, Freitas NAMA, Soares LR, et al. Fatores prognósticos do câncer de mama e sobrevida global em cinco e dez anos na cidade de Goiânia, Brasil: estudo de base populacional. Rev Col Bras Cir. 2017;44(5):435-43. <http://dx.doi.org/10.1590/0100-69912017005003>
6. Anderson WF, Jatoi I, Devesa SS. Distinct breast cancer incidence and prognostic patterns in the NCI's SEER program: suggesting a possible link between etiology and outcome. Breast Cancer Res Treat. 2005;90(2):127-37. <https://doi.org/10.1007/s10549-004-3777-3>
7. Dutra MC, Rezende MA, Andrade VP, Soares FA, Ribeiro MV, Paula EC, et al. Imunofenótipo e evolução do câncer de mama: entre mulheres muito jovens e mulheres na pós-menopausa. Rev Bras Ginecol Obstet. 2009;31(2):54-60. <http://dx.doi.org/10.1590/S0100-72032009000200002>
8. Aquino RGF, Pinheiro LGP, Ferreira MVP, Cavalcanti DIM, Oliveira ALS, Gomes NN, et al. Ductal carcinoma of the breast: morphological aspects according to the age. J Bras Patol Med Lab. 2015;51(4):252-7. <http://dx.doi.org/10.5935/1676-2444.20150042>
9. Ayala ALM, Anjos JC, Cassol GA, Höfelmann DA. Sobrevida em 10 anos em mulheres com câncer de mama: coorte história de 2000-2014. Ciênc Saúde Coletiva. 2019;24(4):1537-50. <http://dx.doi.org/10.1590/1413-81232018244.16722017>
10. Agarwal S, Singh A, Bagga PK. Immunohistochemical evaluation of lymphovascular invasion in carcinoma breast with CD34 and D2-40 and its correlation with other prognostic markers. Indian J Pathol Microbiol. 2018;61(1):39-44. [https://doi.org/10.4103/IJPM.IJPM\\_791\\_16](https://doi.org/10.4103/IJPM.IJPM_791_16)
11. Oliveira Filho HR, Dória MT, Piatto JRM, Soares Junior JM, Filassi JR, Baracat EC, et al. Criteria for prediction of metastatic axillary lymph nodes in early-stage breast cancer. Rev Bras Ginecol Obstet. 2015;37(7):308-13. <http://dx.doi.org/10.1590/S0100-720320150005343>
12. Tabar L, Vitak B, Chen HH, Duffy SW, Yen MF, Chiang CF, et al. The Swedish Two-county trial twenty years later. Updated mortality results and new insights from long-term follow-up. Radiol Clin North Am. 2000;38(4):625-51. [https://doi.org/10.1016/s0033-8389\(05\)70191-3](https://doi.org/10.1016/s0033-8389(05)70191-3)

13. Perou CM, Sorlie MB, Eisen MB, Rijn MV, Jeffrey SS, Rees CA, et al. Molecular portraits of human breast tumours. *Nature*. 2000;406(6797):747-52. <https://doi.org/10.1038/35021093>
14. Ricci MD, Junqueira PAA. Marcadores moleculares em câncer de mama preditivos de metástases axilares. *Rev Assoc Med Bras*. 2008;54(3):189-201. <http://dx.doi.org/10.1590/S0104-42302008000300001>
15. Aquino RGF, Vasques PHD, Cavalcante DIM, Oliveira ALS, Oliveira BMK, Pinheiro LGP. Carcinoma ductal invasor: relação de características anatomopatológicas com a presença de metástases axilares em 220 casos. *Rev Col Bras Cir*. 2017;44(2):163-70. <http://dx.doi.org/10.1590/0100-69912017002010>
16. Hwang KT, Kim YA, Kim J, Chu AJ, Chang JH, Oh SW, et al. The influences of peritumoral lymphatic invasion and vascular invasion on the survival and recurrence according to the molecular subtypes of breast cancer. *Breast Cancer Res Treat*. 2017;163(1):71-82. <https://doi.org/10.1007/s10549-017-4153-4>
17. Buitrago F, Uemura G, Sena MCF. Fatores prognósticos em câncer de mama. *Com Ciências Saúde*. 2011;22(Supl. 1):S69-82.
18. Cheang MC, Chia SK, Voduc D, Gao D, Leung S, Snider J, et al. Ki-67 Index, HER2 status, and prognosis of patients with luminal B breast cancer. *J Natl Cancer Inst*. 2009;101(10):736-50. <https://doi.org/10.1093/jnci/djp082>
19. Shen S, Wu G, Xiao G, Du R, Hu N, Xia X, et al. Prediction model of lymphovascular invasion based on clinicopathological factors in Chinese patients with invasive breast cancer. *Medicine*. 2018;97(43):e12973. <https://doi.org/10.1097/MD.00000000000012973>
20. Wang RX, Chen S, Huang L, Shao ZM. Predictive value and prognosis of matrix metalloproteinase MMP -9 in neoadjuvant chemotherapy for patients with triple-negative breast cancer. *BMC Cancer*. 2018;18:1-8. <https://doi.org/10.1186/s12885-018-4822-7>
21. Marwah N, Batra A, Marwah S, Gupta V, Shakya S, Sen R. Correlation of proliferative index with various clinicopathologic prognostic parameters in primary breast carcinoma: A study from North India. *J Cancer Res Ther*. 2018;14(3):537-42. <https://doi.org/10.4103/0973-1482.167614>
22. Elston CW, Ellis IO. Pathological prognostic factors in breast cancer. The value of histological grade in breast cancer: experience from a large study with long-term follow-up. *Histopathology*. 2002;41(3A):154-61.
23. Bhatti ABH, Jamshed A, Khan A, Siddiqui N, Muzaffar N, Shah MA. Comparison between Early and Late Onset Breast Cancer in Pakistani Women Undergoing Breast Conservative Therapy: is There any Difference? *Asian Pac J Cancer Prev*. 2014;15(13):5331-6. <https://doi.org/10.7314/apjcp.2014.15.13.5331>
24. Rosa LM, Radünz V. Taxa de sobrevida na mulher com câncer de mama: Estudo de Revisão. *Texto Contexto Enferm*. 2012;21(4):980-9.
25. Costa Neto OF, Castro RB, Oliveira CV, Feitosa TVN, Alves Junior JJ, Cavalcante FP, et al. Fatores preditivos de metástases axilares em pacientes com câncer de mama e biópsia de linfonodo sentinela positivo. *Rev Col Bras Cir*. 2017;44(4):391-6. <http://dx.doi.org/10.1590/0100-69912017004014>
26. Bujor IS, Cioca A, Ceausu RA, Veaceslav F, Nica C, Cîmpean AM, et al. Evaluation of Vascular Proliferation in Molecular Subtypes of Breast Cancer. *In Vivo*. 2018;32(1):79-83. <https://doi.org/10.21873/invivo.11207>
27. Pluta P, Jesionek-Kupnicka D, Kubicka-Wolkowska J, Pluta A, Brzozowski K, Potemski P. SMAc protein expression as a potent favorable prognostic factor in locally advanced breast Cancer. *Pol J Pathol*. 2018;69(1):33-41. <https://doi.org/10.5114/pjp.2018.75334>
28. Jafarian A, Tasbandi A, Gilan H, Sheikhi M, Roshan N. Evaluation of CD30/CD4/CD8 in triple-negative invasive ductal carcinoma of breast in association with clinicopathological prognostic factors. *Indian J Pathol Microbiol*. 2018;61(4):500-4. [https://doi.org/10.4103/IJPM.IJPM\\_67\\_18](https://doi.org/10.4103/IJPM.IJPM_67_18)
29. Cheang MCU, Rijn MVD, Nielsen TO. Gene expression. Profiling of breast cancer. *Annu Rev Pathol*. 2008;3:67-97. <https://doi.org/10.1146/annurev.pathmechdis.3.121806.151505>
30. Kraby MR, Valla M, Opdahl S, Haugen OA, Sawicka JE, Engstrom MJ, et al. The prognostic value of androgen receptors in breast cancer subtypes. *Breast Cancer Res Treat*. 2018;172(2):283-96. <https://doi.org/10.1007/s10549-018-4904-x>



# Histopathological and immunohistochemical parameters of breast cancer cases analyzed in a reference laboratory

Marina Crespo Soares<sup>1</sup> , Isabela Juliana Manfredo Rodrigues<sup>1</sup> , Igor Cerejo Tavares da Silva de Almeida<sup>1</sup> , João Victor Pereira Assunção<sup>1</sup> , Andrew Moraes Monteiro<sup>1</sup> , Leônidas Braga Dias Júnior<sup>1</sup> 

## ABSTRACT

**Objective:** To determine the histopathological and immunohistochemical parameters of breast cancer cases treated in Belém, state of Pará, Brazil. **Method:** This is a cross-sectional, retrospective and observational study in which samples from 278 patients were analyzed. In the histopathological analysis were considered, among other factors, the differentiation and histopathological classification of the tumor, based on the WHO classification. As for immunohistochemistry, the presence and intensity of expression of the cell proliferation antigen Ki-67, gene product of HER2, and estrogen and progesterone receptors were evaluated. Then, the tumors were classified into luminal A, luminal B, luminal hybrid, HER2 group, and basal-like. **Results:** The most common histological subtypes were invasive carcinoma of no special type (88.7%), carcinoma *in situ* (5.5%), and invasive mucinous carcinoma (2.9%). The most common immunohistochemical subtypes were luminal A (26.1%), basal-like (23.6%), and luminal B (23.2%). We also found a statistically significant inversely proportional relationship ( $p < 0.01$ ) of hormone receptor expression with nuclear grade. **Conclusion:** The results show the importance of immunohistochemical analysis for staging, as well as for the therapeutic decision of each patient. However, further studies with a larger sample must be performed for more effective analysis of the general population.

**KEYWORDS:** breast cancer; immunohistochemistry; pathology.

## INTRODUCTION

Breast cancer is a heterogeneous disease composed of multiple subgroups associated with distinct biological and histological characteristics, with different forms of clinical manifestation and patterns of response to current therapies. Histologically, invasive tumors are classified as invasive carcinoma of no special type (identified in medical practice as invasive ductal carcinoma — IDC), which corresponds to 70% of cases and is defined as a breast invasive epithelial neoplasm that does not meet the criteria for any special type, constituting a very heterogeneous group of tumors; and as the so-called histological special types, which are more homogeneous, with stricter diagnostic criteria, of which the invasive lobular carcinoma (ILC) is the most prevalent<sup>1</sup>. Histopathological parameters are traditionally used to evaluate tumor evolution by the Brazilian Society of Pathology (*Sociedade Brasileira de Patologia*).

Thus, the analysis of lesion size, axillary lymph node status, nuclear grade, and histological subtype are the basic aspects for

defining primary prognostic factors. Histopathological characteristics of the lesion demonstrate different types of biological behavior of breast tumors<sup>2</sup>.

However, the histological classification of breast cancer has weaknesses. In addition to the subjectivity of the diagnostic criteria, when applying such classification, about 85% of the cases end up belonging to the two main categories of IDC or ILC. Therefore, the system fails to group tumors with a broad biological spectrum and clinical behavior in the same categories, making histologic grading and the immunohistochemical evaluation of estrogen receptor (ER), progesterone receptor (PR), HER2, and the Ki-67 proliferation index to play a key role in increasing the discriminatory value among the different cases of breast carcinoma<sup>3</sup>.

The presence of hormone receptors (HR) is associated with a more favorable prognosis. Therefore, patients with PR-positive tumors have longer disease-free survival and longer survival. Similarly, ER-positive tumors are associated with increased disease-free survival and also with a higher probability of response

<sup>1</sup>Department of Medicine, Universidade do Estado do Pará – Belém (PA), Brazil.

\*Corresponding author: cvuepa@gmail.com

Conflict of interest: nothing to declare.

Received on: 11/12/2019. Accepted on: 12/30/2019.

to hormone therapy. Conversely, patients with negativity for both receptors (ER and PR) showed worse prognosis than those with negativity for only one of the receptors<sup>4</sup>.

Another important tumor marker is the HER2 proto-oncogene, which is responsible for the production of a protein that transmits signals for the growth of epithelial cells, whose expression is often increased in breast cancer. HER2 overexpression results in a more aggressive clinical behavior of the tumor, and the analysis of the marker status is an important factor in detecting types of cancer with a worse prognosis<sup>5,6</sup>.

Tumors with high rates of cell proliferation are predominantly those with a high degree of malignancy. Thus, the evaluation of the mitotic activity is of paramount importance for assessing breast cancer. To that end, the cell proliferation index Ki-67 is used, a monoclonal antibody that detects a nuclear antigen, expressing cells entering the cell cycle and measuring the fraction of cell growth, thus enabling to detect tumors of a worse prognosis<sup>5</sup>.

## METHOD

### Ethical aspects

Patients of the present research were studied according to the precepts of the Declaration of Helsinki and the Nuremberg Code, respecting the Ethical Standards for Research Involving Human Beings (Resolution No. 466/12), of the National Health Council. The investigation started after the submission and approval of the project by the Research Ethics Committee of *Universidade do Estado do Pará* and was authorized by the director in charge of the Paulo C. Azevedo Laboratory (*Laboratório Paulo C. Azevedo*) and the advisor responsible for the research.

### Type of study, study population, and research site

This is a cross-sectional, retrospective, and observational study conducted at the Paulo C. Azevedo Laboratory, from March to June 2017. We evaluated medical reports of the histopathological and immunohistochemical examinations of breast tumors performed in the laboratory from January 2016 to January 2017. A sample of 278 patients was considered, whose size was calculated based on a universe of 1,000 patients.

In order to define this sample size, a formula was used to calculate samples with a universe of less than 100,000, according to Equation 1:

$$N = d^2 \cdot p \cdot q \cdot U / e^2 (U-1) + d^2 \cdot p \cdot q \quad (1)$$

where the universe (U) of y, success rate of 50%, failure rate of 50%, standard deviation (d) of 2, and margin of error of 5% were adopted.

### Inclusion and exclusion criteria

The sample included female patients over 18 years of age, whose medical reports of both histopathological and immunohistochemical examinations were stored in the archives of the Paulo C. Azevedo Laboratory, and who agreed to participate in the research by signing of the Informed Consent Form. All patients who presented only one of the required tests available and those who did not accept to participate in the study were excluded.

In the investigation protocol, the following data were collected: age, variables related to histopathological examination, and variables related to immunohistochemical examination.

Regarding histopathological aspects, the following were analyzed: tumor size; histologic/nuclear grade (differentiation grade); lymph nodes involvement and angiovascular invasion; presence of peritumoral inflammation; appropriate surgical margins; and histopathological classification of the tumor (IDC and ILC). As for immunohistochemical parameters, the following were evaluated: presence and intensity of expression of cell proliferation antigen (Ki-67); product of HER2 oncogene; and intensity of expression and presence of ER and PR (% percentage / + score).

After this evaluation, tumors were classified as: luminal A (ER+ and/or PR+ HER2 — and KI-67<14%); luminal B (ER+ and/or PR+ HER2 — and KI-67≥14%); luminal hybrid (ER+ and/or PR+ HER2+); HER2 group (ER-, PR- HER2+); and basal-like (triple-negative cancer ER-, PR- and HER2-).

Tumor size was classified into four types, according to the TNM classification updated by the American Joint Committee on Cancer<sup>7</sup>:

- T1: tumor size less than or equal to 2 cm in diameter;
- T2: tumor size greater than 2 cm, but less than or equal to 5 cm in its largest dimension;
- T3: tumor size greater than 5 cm in its largest dimension;
- T4: tumor of any size with extension to the chest wall or skin.

For the histological classification of invasive breast carcinoma, the World Health Organization (WHO)<sup>8</sup> proposal was considered, according to Table 1.

### Data analysis

Data were structured in the Microsoft Office Excel 2007 program and analyzed through the IBM Statistical Package for the Social Sciences (SPSS) program, software version 17.0. Descriptive analysis of the number of cases of breast cancer was performed as well as that of absolute and relative frequencies of each subtype of immunohistochemical and histopathological classification. Descriptive statistics of the age of patients affected by cancer were performed considering mean, standard deviation, median, and minimum and maximum values, in addition to the representation of this variable by classification according to menopausal status (cut-off point=50 years of age).

Variables related to immunohistochemical analysis (ER, PR, product of HER2 oncogene, and cell proliferation antigen Ki-67) were cross-checked with the nuclear grade variable in order to verify correlations between them through Spearman's Correlation Coefficient, for ordinal variables, and Pearson's Correlation Coefficient, for scale variables.

Such immunohistochemical variables were also cross-checked with the presence of vascular invasion through the Mann-Whitney U test. The  $p < 0.05$  value was considered in all tests with the cut-off point for statistical significance.

## DISCUSSION

Of the 278 cases of breast cancer analyzed at the laboratory in 2016, 26.1% were of the luminal A subtype; 23.6%, basal-like or triple-negative; and 23.2%, luminal B, as observed in Table 2. The results differ from those found by Cintra et al.<sup>5</sup>, in whose study 41.8% of cases were classified as luminal B. However, the percentage of triple-negative subtypes was 24.2%, similar to that of the present study. Pérez-Rodríguez<sup>9</sup>, in a study with 1,380 Mexican women, achieved similar results: luminal A was the most prevalent subtype, though with the most expressive percentage, of 65%, followed by the triple-negative (14%), and luminal B (12%). Mendoza del Solar et al.<sup>10</sup> found frequency of the triple-negative

subtype in 30% of their sample, a number in line with our data. The triple-negative subtype is associated with more aggressiveness and worse survival<sup>10</sup>.

It is worth highlighting a key point in the research conducted by Pérez-Rodríguez<sup>9</sup>: the luminal B subtype was classified according to the positivity of ER, PR, and HER2, which represents the luminal hybrid subtype of our study. This fact may explain the most expressive percentage of the luminal A subtype, since we considered cases with positivity for ER and PR in this subtype, and disregarded the percentage and the expression of the Ki-67 marker, which are generally used to distinguish luminal A and luminal B subtypes<sup>11</sup>.

The fourth most frequent subtype was the luminal hybrid (13.8%) (ER+ and/or PR+ HER2+), a subtype poorly considered in similar research. The HER2+ subtype represented 10.1% of the cases analyzed in the period, a slightly higher value than the 8.92% perceived by Cherbal et al.<sup>12</sup> Southeast and South regions, with a higher percentage of European ancestry and higher socioeconomic status, tend to have a higher percentage of luminal tumors. The Northern Region presented more aggressive subtypes (HER2+ and triple-negative), whereas in the Midwest cases of triple-positive carcinomas prevailed. The Northeast, a region with a high percentage of African ancestry, presented intermediate frequency<sup>13</sup>. This observation by Carvalho et al.<sup>13</sup> may partly explain why, in the present study, lower percentages of luminal carcinomas and higher percentages

**Table 1.** Histological classification of invasive breast carcinoma.

Histological types
Invasive carcinoma of no special type
Invasive lobular carcinoma
Tubular carcinoma
Cribiform carcinoma
Carcinoma with medullary features
Metaplastic carcinoma
Carcinoma with apocrine differentiation
Adenoid cystic carcinoma
Mucoepidermoid carcinoma
Polymorphous adenocarcinoma
Mucinous carcinoma and signet ring cell carcinoma
Carcinoma with neuroendocrine features
Invasive papillary carcinoma
Invasive micropapillary carcinoma
Secretory carcinoma
Oncocytic carcinoma
Sebaceous carcinoma
Lipid-rich carcinoma
Glycogen-rich clear cell carcinoma
Acinar cell carcinoma

Source: WHO<sup>8</sup>.

**Table 2.** Prevalence of breast cancer in a laboratory at Belém (PA), Brazil, in 2016, according to histopathological and immunohistochemical classifications.

Tumor subtypes	Frequency	
	N	%
Histopathological subtypes		
Squamous cell carcinoma	2	0.7
Carcinoma <i>in situ</i>	15	5.5
Signet ring cell carcinoma	1	0.4
Invasive carcinoma of no special type	244	88.7
Invasive lobular carcinoma	3	1.1
Invasive mucinous carcinoma	8	2.9
Invasive papillary carcinoma	2	0.7
Molecular subtypes		
Luminal A	72	26.1
Luminal B	64	23.2
Luminal hybrid	38	13.8
HER2	28	10.1
Basal-like	65	23.6
Unspecified	9	3.2

of triple-negative carcinomas were found when compared with those in the global literature.

Sánchez-Muñoz et al.<sup>14</sup>, in a study with Spanish women, found a higher prevalence of luminal B subtype (51%), followed by luminal A (19%) and basal-like (5%) subtypes. Fourati et al.<sup>15</sup> identified a higher prevalence of luminal A (50.7%), followed by triple-negative (22.5%), and luminal B (13.4%) tumor subtypes. These variations are due to differences between the analyzed populations and also the use of different classification parameters, in addition to the immunohistochemistry itself<sup>16</sup>.

The mean age at diagnosis was 53 years ( $\pm 13.1$ ), an age very similar to that surveyed by Pérez-Rodríguez<sup>9</sup>, which was 53.3 years, and slightly below the mean of 57.5 years observed by Meattini et al.<sup>17</sup> However, the mean age observed by our study is slightly above that obtained by Cherbal et al.<sup>12</sup> These differences may occur due to the heterogeneous variety of women analyzed in these studies.

Regarding the histological classification of breast cancer cases, the most frequent type found in the present study was invasive carcinoma of no special type (88.7%), followed by carcinoma *in situ* (5.5%), and invasive mucinous carcinoma (2.9%). The frequency of invasive carcinomas of no special type in this study was higher than that identified by Caldarella et al.<sup>18</sup>, of 58.5%. Meattini et al.<sup>17</sup> found IDC as the most common histological subtype (64%). Considering the new classification of invasive breast carcinomas according to the WHO<sup>8</sup>, this subtype is included in the group of invasive carcinoma of no special type. The other histological types found were: ILC (1.4%), invasive papillary carcinoma (0.7%), and squamous cell carcinoma (0.7%). These data partly differ from the literature, especially when considering the low prevalence of ILC, which is generally responsible for 15% of breast cancer cases<sup>8</sup>.

In a study conducted in Brazil, Smaniotto et al.<sup>19</sup> identified 70.49% of patients (n=86) with the IDC type. The second most frequent lesion was ILC, in 9.84% of cases (n=12). Furthermore, the authors pointed out 7.38% of cases of ductal carcinoma *in situ* (n=9). There was an incidence of 12.29% (n=15) for other types such as infiltrating ductal carcinoma, well-differentiated adenocarcinoma, invasive mucinous carcinoma, undifferentiated metaplastic carcinoma, and absence of carcinoma after neo-adjuvant chemotherapy. These data partially corroborate the results of our study, especially when considering the high frequency of IDC; nevertheless, they differ regarding percentages of invasive lobular carcinoma and carcinoma *in situ*, which, in the first study, are higher.

According to Table 3, it can be observed that the expression of ER and PR was inversely proportional to the nuclear grade. Therefore, the highest expression of HR (ER and PR) was related to the lower nuclear grade. This inverse correlation proved to be statistically significant ( $p < 0.01$ ), similar to the findings of Dayal et al.<sup>20</sup>, according to which when ER expression was

null, the incidence of nuclear grade 3 was higher than 50%. Conversely, when the expression of ER was 3+, there was a higher incidence of nuclear grade 1. In a similar study conducted in Asia<sup>21</sup>, ER positivity was observed in 70% of grade I carcinomas; in 48.2% of grade II; and in 3.5% of grade III ( $p < 0.001$ ). Likewise, PR positivity was perceived in 70% of grade I carcinomas; in 36.14% of grade II; and in 1.75% of grade III ( $p < 0.001$ ), which corroborates our results. Thus, we can perceive that better-differentiated tumors (lower nuclear grade) are more likely to be ER and PR positive, in addition to having a relatively better prognosis, since it is known that the presence of HR (ER and PR) in the tumor tissue is well correlated with the response to hormone therapy and chemotherapy<sup>22</sup>.

On the other hand, we observed that the increased expression of Ki-67 was related to a higher incidence of high nuclear grade, since we found a positive and statistically significant correlation. This shows that high cell proliferation, demonstrated in the overexpression of Ki-67, is mainly present in carcinomas of higher histologic grade, being a marker of tumor progression and worse prognosis<sup>23</sup>. Such a result is in line with the findings of Narbe et al.<sup>24</sup>, who also verified a significant positive correlation between Ki-67 and histologic grade ( $p < 0.001$ ), observing grade III tumors and Ki-67 mean value of 23.2%.

Moreover, Table 3 illustrates that HER2, although not statistically significant ( $p > 0.211$ ), presented the same trend as Ki-67 in relation to the histologic grade. A similar result was found by Arantes Júnior<sup>25</sup>, who did not observe a statistically significant correlation, although he pointed out that the overexpression of HER2 was related to high nuclear grade ( $p$ -value ranging from 0.113 to 0.451). Thus, we found that the overexpression of HER2 seems to be an independent marker of biological aggressiveness, since it has no statistical significance when related to different levels of nuclear grade. Its overexpression in breast cancer indicates decreased survival due to poor prognosis and low response to tamoxifen (hormone therapy)<sup>22</sup>.

Concerning tumor size, the mean size in patients with ER-positive tumors was 3.52 cm *versus* 3.73 cm in patients with ER-negative tumors, according to Table 4. Similarly, in patients with PR-positive tumors, the mean tumor size was 3.51 *versus* 3.72 cm in patients with PR-negative tumors; however, no significant correlation was established between tumor size and HR expression ( $p = 0.714$  and  $p = 0.698$ , respectively). A similar result was found by Dayal et al.<sup>20</sup> and Ariga et al.<sup>26</sup>

It is known that lymph node status is important for determining breast cancer staging and treatment options. It is noteworthy that lymph node status consists of the most relevant factor in the prognosis of patients with breast cancer, since, as the number of positive axillary lymph nodes and the recurrence rate increase, the survival rate decreases. According to previous studies<sup>20,27,28</sup>, there is a statistically significant correlation between HER2 expression and lymph node involvement and

vascular invasion, which has not been demonstrated for ER and PR. Nevertheless, this correlation was not found for any of these biomarkers in the present study.

### CONCLUSION

Breast cancer is complex and heterogeneous, in addition to having a high prevalence in the female population. Hence, its correct classification is paramount for the best staging of the disease as well as for choosing the most appropriate therapeutic option. Therefore, immunohistochemical evaluation is key for the best diagnostic accuracy when associated with the tumor histopathological examination.

The present study aimed to evaluate the expression of ER and PR, the presence of HER2 oncogene, and proliferation antigen Ki-67, correlating them with the nuclear grade of the tumor. A higher prevalence of luminal A subtype was perceived, in addition to an inversely proportional relationship between the presence of HR and the nuclear grade of the tumor, with statistical relevance ( $p < 0.01$ ). Moreover, an important relationship was observed between the expression of the antigen Ki-67 and lower

nuclear grade, i.e., with a lower differentiation grade and, consequently, worse prognosis.

**Table 4.** Distribution of the intensity of expression of hormone receptors according to tumor size.

Expression of hormone receptors	N	Tumor size		
		Mean $\pm$ standard deviation	Pearson's Correlation	P
<b>Estrogen receptor</b>				
Absent	96	3.79 $\pm$ 3.03	-0.52	0.55
1+	27	3.87 $\pm$ 2.68		
2+	32	3.55 $\pm$ 2.20		
3+	120	3.47 $\pm$ 3.01		
<b>Progesterone receptor</b>				
Absent	115	3.77 $\pm$ 2.95	-0.61	0.49
1+	28	3.60 $\pm$ 1.96		
2+	17	4.91 $\pm$ 3.58		
3+	115	3.34 $\pm$ 2.95		

**Table 3.** Correlation between intensity of expression of hormonal receptors, HER2 score, and Ki-67 product according to nuclear grade.

Expression intensity	Nuclear grade						Mean $\pm$ standard deviation	Spearman's Correlation Coefficient
	1		2		3			
	N	%	N	%	N	%		
<b>Estrogen receptor</b>								
Absent	0	0.0	41	54.7	34	45.3	2.45 $\pm$ 0.50	-0.278*
1+	2	9.1	13	59.1	7	31.8	2.22 $\pm$ 0.61	
2+	0	0.0	20	83.3	4	16.7	2.16 $\pm$ 0.38	
3+	9	8.7	74	71.8	20	19.4	2.10 $\pm$ 0.52	
<b>Progesterone receptor</b>								
Absent	1	1.1	51	55.4	40	43.5	2.42 $\pm$ 0.51	-0.312*
1+	2	9.1	15	68.2	5	22.7	2.13 $\pm$ 0.56	
2+	0	0.0	8	53.3	7	46.7	2.46 $\pm$ 0.51	
3+	8	8.4	74	77.9	13	13.7	2.05 $\pm$ 0.46	
<b>HER2 Product</b>								
Absent	4	4.7	56	65.9	25	29.4	2.24 $\pm$ 0.53	0.084
1+	6	7.9	56	73.7	14	18.4	2.10 $\pm$ 0.50	
2+	0	0.0	6	85.7	1	14.3	2.14 $\pm$ 0.37	
3+	2	3.5	30	52.6	25	43.9	2.40 $\pm$ 0.56	
<b>Ki-67 product score</b>								
[0.0–25.0%]	10	9.1	84	76.4	16	14.5	2.05 $\pm$ 0.48	0.367*
[25.0–50.0%]	1	2.2	30	65.2	15	32.6	2.30 $\pm$ 0.51	
[50.1–75%]	0	0.0	14	48.3	15	51.7	2.51 $\pm$ 0.50	
>75.0%	0	0.0	19	50.0	19	50.0	2.50 $\pm$ 0.50	

\*Statistically significant difference ( $p < 0.01$ ) according to Spearman's Correlation Coefficient.



These results demonstrate the importance of tumor analysis performed according to immunohistochemistry and associated with histopathology. However, it is worth emphasizing that our research has limitations, especially due to the sample, and should be complemented with further studies addressing a larger number of patients.

## AUTHORS' CONTRIBUTION

M.C.S.: wrote the original draft; I.J.M.R wrote the original draft.  
I.C.T.S.A.: wrote the original draft.  
J.V.P.A.: wrote the original draft.  
A.M.M.: wrote the original draft.  
L.B.D.J.: supervised and wrote the original draft.

## REFERENCES

- Geyer FC, De Nigro MV. Tipos histológicos especiais de câncer de mama. *Rev Onco&*. 2013;15:28-32.
- Goldhirsch A, Winer EP, Coates AS, Gelber RD, Piccart-Gebhart M, Thürlimann B, et al. Personalizing the treatment of women with early breast cancer: highlights of the St Gallen International Expert Consensus on the Primary Therapy of Early Breast Cancer 2013. *Ann Oncol*. 2013;24(9):2206-23. <https://doi.org/10.1093/annonc/mdt303>
- Viale G. The current state of breast cancer classification. *Ann Oncol*. 2012;23(Supl. 10):x207-10. <https://doi.org/10.1093/annonc/mds326>
- Pachnicki JPA, Czezczko NG, Tuon F, Cavalcanti TS, Malafaia AB, Tuleski AM. Avaliação imunoistoquímica dos receptores de estrogênio e progesterona no câncer de mama, pré e pós-quimioterapia neoadjuvante. *Rev Col Bras*. 2012;39(2):86-92. <http://dx.doi.org/10.1590/S0100-69912012000200002>
- Cintra JRD, Teixeira MTB, Diniz RW, Gonçalves Junior H, Florentino TM, Freitas GF, et al. Perfil imuno-histoquímico e variáveis clinicopatológicas no câncer de mama. *Rev Assoc Med Bras*. 2012;58(2):178-87. <http://dx.doi.org/10.1590/S0104-42302012000200013>
- Becker RG, Galia CR, Morini S, Viana CR. Expressão imuno-histoquímica das proteínas vegf e her-2 em biópsias de osteossarcoma. *Acta Ortop Bras*. 2013;21(4):233-83.
- American Joint Committee on Cancer (AJCC). *Cancer Staging Manual*. 6ª ed. AJCC; 2002.
- Lebeau A, Kriegsmann M, Burandt E, Sinn HP. [Invasive breast cancer: the current WHO classification]. *Pathologe*. 2014;35(1):7-17. <https://doi.org/10.1007/s00292-013-1841-7>
- Pérez-Rodríguez G. Prevalence of breast cancer sub-types by immunohistochemistry in patients in the Regional General Hospital 72, Instituto Mexicano del Seguro Social. *Cir Cir*. 2015;83(3):193-8. <https://doi.org/10.1016/j.circir.2015.05.003>
- Mendoza del Solar G, Echegaray A, Caso C. Perfil imunohistoquímico del cáncer de mama en pacientes de un hospital general de Arequipa, Perú. *Rev Med Hered*. 2015;26(1):31-4.
- Hammond MEH, Hayes DF, Dowsett M, Allred DC, Hagerty KL, Badve S, et al. American Society of Clinical Oncology/College of American Pathologists guideline recommendations for immunohistochemical testing of estrogen and progesterone receptors in breast cancer. *J Clin Oncol*. 2010;28(16):2784-95. <https://doi.org/10.1200/JCO.2009.25.6529>
- Cherbal F, Gaceb H, Mehemmai C, Saiah I, Bakour R, Rouis AO, et al. Distribution of molecular breast cancer subtypes among Algerian women and correlation with clinical and tumor characteristics: a population-based study. *Breast Dis*. 2015;35(2):95-102. <https://doi.org/10.3233/BD-150398>
- Carvalho FM, Bacchi LM, Pincerato KM, Van de Rijn M, Bacchi CE. Geographic differences in the distribution of molecular subtypes of breast cancer in Brazil. *BMC Womens Health*. 2014;14:102. <https://doi.org/10.1186/1472-6874-14-102>
- Sánchez-Muñoz A, Román-Jobacho A, Pérez-Villa L, Sánchez-Rovira P, Miramón J, Pérez D, et al. Male breast cancer: immunohistochemical subtypes and clinical outcome characterization. *Oncology*. 2012;83(4):228-33. <https://doi.org/10.1159/000341537>
- Fourati A, Boussen H, El May MV, Goucha A, Dabbabi B, Gamoudi A, et al. Descriptive analysis of molecular subtypes in Tunisian breast cancer. *Asia Pac J Clin Oncol*. 2014;10(2):e69-74. <https://doi.org/10.1111/ajco.12034>
- Hagemann IS. *Molecular Testing in Breast Cancer: A Guide to Current Practices*. *Arch Pathol Lab Med*. 2016;140(8):815-24. <https://doi.org/10.5858/arpa.2016-0051-RA>
- Meattini I, Bicchierai G, Saieva C, De Benedetto D, Desideri I, Becherini C, et al. Impact of molecular subtypes classification concordance between preoperative core needle biopsy and surgical specimen on early breast cancer management: Single-institution experience and review of published literature. *Eur J Surg Oncol*. 2017;43(4):642-8. <https://doi.org/10.1016/j.ejso.2016.10.025>
- Caldarella A, Buzzoni C, Crocetti E, Bianchi S, Vezzosi V, Apicella P, et al. Invasive breast cancer: a significant correlation between histological types and molecular subgroups. *J Cancer Res Clin Oncol*. 2013;139(4):617-23. <https://doi.org/10.1007/s00432-012-1365-1>
- Smaniotta ACR, Oliveira HR, Botogoski SR, Nalevaiko JZ, Costa L, Damião N. Perfil clínico, histológico e biológico de pacientes submetidos à biópsia do linfonodo sentinela por câncer de mama. *Arq Med Hosp Fac Cienc Med Santa Casa São Paulo*. 2013;58(3):121-6.
- Dayal A, Shah JR, Kothari S, Patel SM. Correlation of Her-2/neu Status With Estrogen, Progesterone Receptors and Histologic Features in Breast Carcinoma. *Ann Pathol Laboratory Medicine*. 2016;3(5 Supl.):477-83.

21. Azizun-Nisa, Bhurgri Y, Raza F, Kayani N. Comparison of ER, PR & HER-2/neu (C-erb B 2) Reactivity Pattern with Histologic Grade, Tumor Size and Lymph Node Status in Breast Cancer. *Asian Pac J Cancer Prev*. 2008;9(4):553-6.
22. Siadati S, Sharbatdaran M, Nikbakhsh N, Ghaemian N. Correlation of ER, PR and HER-2/Neu with other Prognostic Factors in Infiltrating Ductal Carcinoma of Breast. *Iran J Pathol*. 2015;10(3):221-6.
23. Wang B, Wang X, Wang J, Xuan L, Wang Z, Wang X, et al. Expression of Ki67 and clinicopathological features in breast cancer. *Zhonghua Zhong Liu Za Zhi*. 2014;36(4):273-5.
24. Narbe U, Bendahl PO, Grabau D, Rydén L, Ingvar C, Fernö M. Invasive lobular carcinoma of the breast: long-term prognostic value of Ki67 and histological grade, alone and in combination with estrogen receptor. *SpringerPlus*. 2014;3:70. <https://doi.org/10.1186/2193-1801-3-70>
25. Arantes Júnior JC. Perfis Histopatológico e Imunohistoquímico do câncer de mama: Comparação entre lesões palpáveis e não-palpáveis [tese]. Botucatu: Universidade Estadual Paulista "Júlio de Mesquita Filho"; 2006.
26. Ariga R, Zarif A, Korasick J, Reddy V, Siziopikou K, Gattuso P. Correlation of Her-2/neu gene amplification with other prognostic and predictive factors in female breast carcinoma. *Breast J*. 2005;11(4):278-80. <https://doi.org/10.1111/j.1075-122x.2005.21463.x>
27. Tokatli F, Altaner S, Uzal C, Ture M, Kocak Z, Uygun K, et al. Association of HER-2 over expression with the number of involved axillary lymph nodes in human receptor positive breast cancer patients. *Exp Oncol*. 2005;27(2):145-9.
28. Abdollahi A, Sheikhabaei S, Safinejad S, Jahanzad I. Correlation of ER, PR, HER- 2 and P53 Immunoreactions with Clinico-Pathological Features in Breast Cancer. *Iran J Pathol*. 2013;8(3):147-52.



# Factors related to non-mammographic visualization in locally advanced breast carcinoma

Anapaula Hidemi Uema Watanabe<sup>1</sup>, Marcio Mitsugui Saito<sup>1</sup>,  
Bruno Eduardo Fernandes Cabral<sup>1</sup>, René Aloisio da Costa Vieira<sup>1,2,3</sup> 

## ABSTRACT

**Objective:** To determine the rate and factors related to non-visualization of locally advanced breast cancer (LABC) by mammography. **Method:** Prospective, cross-sectional study, conducted in a cohort of consecutive patients with LABC treated at a tertiary cancer hospital. All patients were systematically examined and underwent high-resolution mammography (conventional equipment) in two views (craniocaudal and mediolateral oblique). A blind study was performed in which mammograms were mixed with routine and where radiologists were unaware of the clinical data. Three radiologists evaluated the examinations. In the patients in whom the findings were negative, the possible causes responsible for not identifying the tumor on mammography were evaluated. After the radiological report, the examinations were reviewed, and the radiological data were added to the standard form, making up the database of the present study. Descriptive statistics were used to compare factors related to non-visualization of tumors, namely the chi-square test and the Mann-Whitney test. **Result:** Eighty-five patients were evaluated. The average size of the tumors was 6.96 cm, and 20% of cases were not identified on mammography. Among the causes, 76.4% had dense parenchyma, 17.6% were not visible on examination, and in 5.8%, the lesion was not noticed by the radiologist (false negative examination). The only factor found when LABC was not identified was the type of breast parenchyma ( $p=0.04$ ). **Conclusion:** Clinical history and changes in physical examination should be considered in the report to the radiologist. High breast density was the major obstacle to mammography diagnosis.

**KEYWORDS:** breast neoplasms; mammography; predictive value of tests; diagnostic errors.

## INTRODUCTION

Mammography is one of the main radiological modalities for the diagnosis of breast lesions. It is related to the reduction of breast cancer mortality<sup>1,2</sup>. However, about 10 to 30% of breast cancers may not be diagnosed on mammography, the possible causes being: dense breast parenchyma, errors in perception, incorrect interpretation of suspicious findings, tenuous characteristics of malignancy and slow growth of a lesion<sup>3-6</sup>.

In Brazil, there are several problems in mammographic screening, in which many patients, even if symptomatic, use mammographic screening campaigns of diagnostic task force to obtain diagnostic mammography.

Associated with this fact is that there is a delay in diagnosis along with the lack of appreciation of clinical complaints, and limitations of the health system, either because of the delay in

mammographic results, associated with the quality of the mammography, or errors in the mammographic diagnosis process<sup>7,8</sup>. In patients who have gotten a mammogram properly, there can be issues such as interval tumors and the regular use of non-digital mammography<sup>7</sup>. Thus, many factors can lead to a negative finding, which can have medico-legal implications.

Locally advanced breast cancer (LABC) is still common in our country<sup>9</sup>, mainly due to the lack of regular mammography, apart from difficulties in patient navigation to all diagnostic examinations<sup>10</sup>.

There is a lack of studies that assess the percentage of lesions that are not identifiable by mammography. The identification of the factors associated with the non-visualization of tumors, even in LABC, is of utmost importance, aiming at a better understanding of the late diagnosis and the underestimation of potential radiological findings, justifying the present investigation.

<sup>1</sup>Barretos Cancer Hospital – Barretos (SP), Brazil.

<sup>2</sup>Botucatu School of Medicine – Botucatu (SP), Brazil.

<sup>3</sup>Muriae Cancer Hospital – Muriae (MG), Brazil.

\*Corresponding author: posgrad@hcancerbarretos.com.br

Conflict of interests: nothing to declare.

Received on: 03/30/2019. Accepted on: 12/11/2019

## METHOD

We conducted a prospective, controlled study in patients with LABC, seen at a tertiary oncology hospital of the Unified Health System (SUS); the study was approved by the Research Ethics Committee No. 135/2008, which was registered at [www.clinicaltrials.gov](http://www.clinicaltrials.gov), NCT 00820690. Patients with non-metastatic LABC were evaluated. Data were collected from June 2008 to December 2009.

All patients with stage III breast cancer were submitted to a diagnostic delay questionnaire, systematically being directed to clinical examination, new mammography and breast ultrasound.

The inclusion criteria were:

- Patients with LABC, non-metastatic, stage III;
- Eastern Cooperative Oncology Group (ECOG scale) 0 or I;
- Confirmed diagnosis of invasive ductal or lobular carcinoma.

The exclusion criteria were:

- Patients with extensive *peau d'orange*;
- Pregnant women;
- Primary inflammatory carcinoma;
- Ulcerated tumor;
- Failure to sign the informed consent form.

The patients underwent high-resolution mammography using computerized radiography equipment in two views (craniocaudal and mediolateral). The images were sent blindly and independently to three radiologists with extensive experience who were unaware of patient data and physical examination. In addition, these patients underwent ultrasound with dedicated high-frequency transducers; this was to assess the correlation between clinical examination and imaging examination. The density of the parenchyma was divided into four categories: breast almost entirely fat, breast with scattering of fibroglandular tissues, breast heterogeneously dense, and breast extremely dense; this is the new classification by the Breast Imaging-Reporting and Data System (BI-RADS). In patients with negative findings, the possible causes responsible for the failure to identify the tumor on mammography were evaluated. After the radiological report, and later, the data related to the radiological findings were added to the form, making up the database of the present study.

The data were recorded on a standard form and digitized for evaluation using the IBM Statistical Package for the Social Sciences (SPSS) for Mac, version 22. Descriptive statistics of the patients and mammographic findings are presented in Tables 1 and 2. We tried to group the main findings and compare them with non-identification in the mammographic examination, aiming to evaluate potential causes for the lack of identification of the lesion (Table 3). The  $\chi^2$  test was used to compare factors related to the non-visualization of tumors, and Fisher's test was used with values below 5. Continuous variables were assessed using the Mann-Whitney test. Values below 5% were considered significant.

## RESULTS

Eighty-five patients, diagnosed with LABC, were evaluated. The main clinical findings are shown in Table 1. Mean age was 46.4 years (from 21.5 to 68.4 years). All patients were symptomatic and had a mean ( $\pm$  SD) complaint time and tumor size of  $12.2 \pm 11.6$  months and  $6.9 \pm 2.5$  cm (2 to 15 cm), respectively. Of the total, 97.6% had unilateral involvement. Evaluating the clinical staging, 56.5% had stage IIIA, and 62.4% were T3, 72.9% N1 and 86.9% invasive ductal carcinoma.

Mammographic findings (Table 2) showed that 25.8% of patients had a dense or heterogeneous breast parenchyma. The main mammographic findings were the presence of a nodule (82.4%), microcalcifications (38.8%) and suspect lymph nodes (34.1%).

Of the patients, 81 (96.4%) underwent breast ultrasound. According to the echogenicity of the parenchyma, most were heterogeneous (45.7%), showing an irregular nodule (77.8%), with a hypoechoic pattern (93.8%) and shadow (61.7%) or posterior reinforcement (12.3%).

Of the lesions identified on physical examination, 20% (n=17) were not diagnosed on mammography (Table 1). Among the causes, 76.4% had dense parenchyma, 17.6% were not visible on examination, and in 6%, the lesion was not noticed by the radiologist (false negative). Figure 1 exemplifies a LABC case in which the tumor was not seen on mammography in a patient with a dense breast. Comparing the age group and the grouping of the main radiological findings, we found that the only and main factor associated with the non-identification of LABC was the type of breast parenchyma ( $p = 0.04$ ; Table 3). Multivariate calculations were not performed because a single factor was identified with  $p < 0.10$ .

## DISCUSSION

In general, the mammography examination in asymptomatic women is associated with a rate of non-visualization of lesions of around 10%. The findings of this study are noteworthy, in which 20% of symptomatic patients with confirmed biopsy had a normal mammography examination. This fact denotes the importance of the clinical data (asymptomatic/symptomatic) associated with the mammographic examination, as well as the inclusion of clinical information<sup>8</sup>, since the radiological evaluation occurred blindly and since the radiologists were unaware of the patients' data.

There are barriers related to delayed diagnosis<sup>11</sup> relating to the health system, which can lead to an increase in the time between examinations; these can be problems related to the quality of radiological examinations, socioeconomic status, and distance from the referral service. In places where there is a limitation for the performance of a mammogram by SUS, in the presence of joint efforts or in opportunistic screening, the patient is able to get a radiological breast assessment, with the aim of reaching the referral service faster<sup>8,12</sup>. This fact is associated with problems in the patient's navigation, that is, in undergoing additional

tests until the definitive diagnosis of the neoplasm<sup>13</sup>, which is common in our country, where patients take a long time from the onset of symptoms to diagnosis, often requiring additional tests and then being sent to the referral service for treatment<sup>14</sup>. Evaluating factors against the patient, there may be radiological characteristics that hinder the clear mammographic visualization of the lesion and tumor doubling time<sup>15</sup>. In this case series, only patients with LABC were included. Although LABC may be associated with smaller tumors, with extensive axillary involvement (N2/N3), this portion represented only 20% of the sample, and the tumor size and lymph node involvement were not associated with non-visualization.

**Table 1.** Clinical parameters and main mammographic findings.

Clinical finding	Parameter	Value (%)
Size	Mean (cm)	6.9±2.5
Age range	<40	25 (29.4)
	40 to 49	29 (34.1)
	≥50	31 (36.5)
Side	Right	29 (34)
	Left	56 (66)
Laterality	Unilateral	83 (97.6)
	Bilateral	2 (2.4)
T-TNM stage	T2	1 (1.2)
	T3	53 (62.4)
	T4	31 (36.5)
N-TNM stage	N0	6 (7.1)
	N1	62 (72.9)
	N2	14 (16.5)
	N3	3 (3.5)
TNM stage	IIIA	48 (56.5)
	IIIB	33 (38.8)
	IIIC	4 (4.7)
Histology	IDC	73 (86.9)
	ILC	5 (5.9)
	Others	7 (8.3)
<b>Tumor in mammogram</b>		
Size	Mean (cm)	6.2±1.9
Visualization	Two views	64 (75.3)
	One view	3 (3.5)
	Not visualized	17 (20)
Reason for non-visualization of tumors	Dense parenchyma	13 (76.4)
	Not visible on examination	3 (17.6)
	Lack of perception	1 (6)

TNM: TNM staging system; IDC: invasive ductal carcinoma; ILC: invasive lobular carcinoma

The literature notes that mammography screening is performed in women over 40 years of age<sup>2</sup>. This study included women in a higher age group, but all had clinical evidence of a breast tumor, and the objective was to evaluate aspects associated with the non-visualization of tumors in the mammographic examination, demonstrating that breast density is an important factor, which is associated with age; however, age group was not seen to be an important factor here.

Several factors can influence non-visualization of tumors on mammography, and they can be grouped into four main ones<sup>3-6</sup>:

**Table 2.** Radiological mammography findings.

Radiological finding	Parameter	Value (%)
Parechyma	Lipo-substituted (0–25%)	30 (35.3)
	Partially lipo-substituted (25–50%)	33 (38.8)
	Heterogeneously dense (51–75%)	15 (17.6)
	Dense (>75%)	7 (8.2)
Skin	Normal	33 (38.8)
	Retracted	26 (30.6)
	Thickened	20 (23.5)
	Thickened + retracted	6 (7.1)
Nodule	Spiculated	27 (31.8)
	Irregular	24 (28.2)
	Lobulated	12 (14.1)
	No nodule	15 (17.6)
	Regular	7 (8.2)
Nodule border	Irregular	44 (51.8)
	Lobulated	25 (29.4)
	Not visible	14 (16.5)
Microcalcifications	Regular	2 (2.4)
	Absent	52 (61.2)
	Pleomorphic	11 (12.9)
Microcalcification distribution	Other	22 (25.9)
	Absent	52 (61.2)
	Grouped	19 (22.4)
	Segmented	9 (10.6)
Asymmetry	Ductal	5 (5.9)
	Absent	72 (84.7)
	Focal	9 (10.6)
Lymph node	Diffuse	4 (4.7)
	Not visualized	30 (35.3)
	Normal	26 (30.6)
	Dense	17 (20)
	Others	12 (14.1)

- patient (inherent or acquired dense breasts);
- tumor factors (minimal carcinoma, multifocal carcinoma and multicentric carcinoma);
- factors associated with the mammography technique (inadequate exposure factors, poorly positioned breasts and poor processing quality);

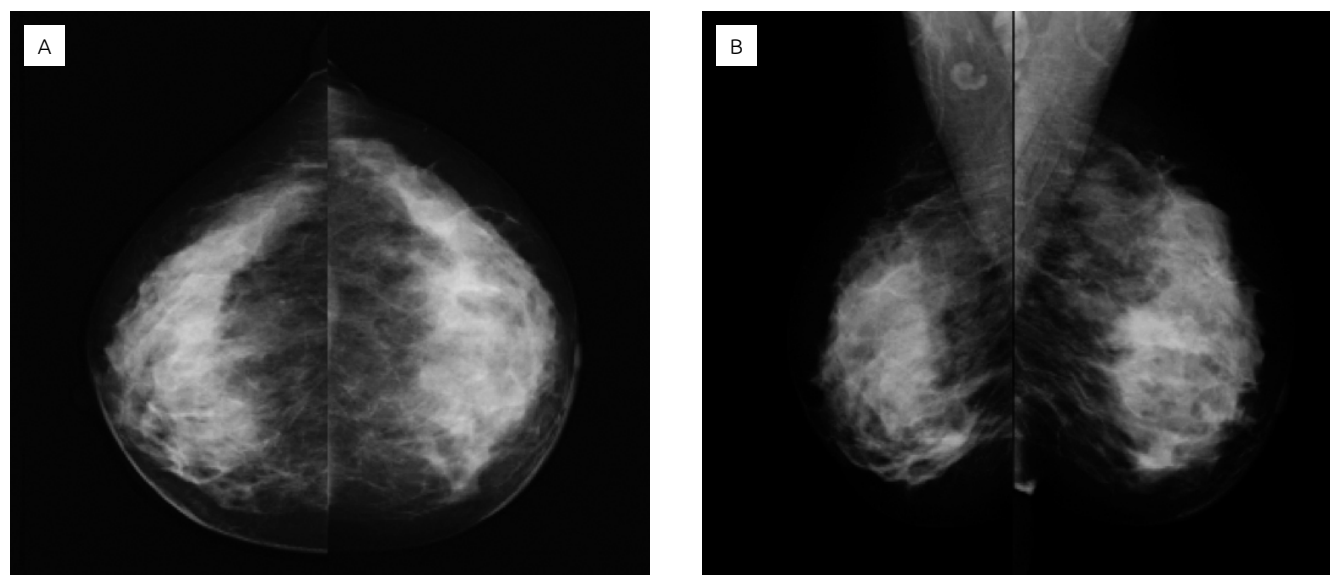

**Figure 1.** Mammography with no visible finding of tumor. Invasive ductal carcinoma in the left breast, T2N2M0 (stage IIIA).

**Table 3.** Factors related to non-identification of locally advanced breast cancer by mammography.

Category	Variable	Not identified n (%)	Identified n (%)	p
Clinical				
Size	Mean±SD	7.3±3.2	6.8±2.3	0.83
Age group	<40	5 (20)	20 (80)	0.74
	40 to 49	7 (24.1)	22 (75.9)	
	≥50	5 (16.1)	26 (83.9)	
Histology	IDC	16 (21.9)	57 (78.1)	0.46
	ILC	0	5 (100)	
	Others	1 (14.3)	6 (85.7)	
N-TNM	N0-1	13 (19.1)	55 (80.9)	0.74
	N2-3	4 (23.5)	13 (76.5)	
Mammography				
Parenchyma	0–25%	3 (10)	27 (90)	0.04
	51–75%	6 (40)	9 (60)	
	>75%	3 (42.9)	4 (57.1)	
Skin	Normal	5 (15.2)	28 (84.8)	0.42
	Anormal	12 (70.6)	40 (76.9)	
Nodule	No nodule	5 (33.3)	10 (66.7)	0.17
	Nodule	12 (17.1)	58 (82.9)	
Microcalcification	Absent	12 (23.1)	40 (76.9)	0.42
	Pathological	5 (15.2)	28 (80)	
Lymph node	Absent/not visualized	13 (23.2)	43 (76.8)	0.40
	Altered	4 (13.8)	25 (86.2)	

N-TNM: nodal TNM stage; SD: standard deviation; IDC: invasive ductal carcinoma; ILC: invasive lobular carcinoma

- factors related to mammographic evaluation (poor perception and misinterpretation).

Even in the presence of negative radiological findings, mammographic screening is associated with the presence of interval tumors, which can be divided into true tumors, minimal findings and false negative tests (underestimation of radiological findings), making additional examinations and systematic clinical evaluation necessary, a fact that should determine the search for a professional, with the aim of repeating the examinations or combination of complementary examinations<sup>16</sup>. Microcalcifications and asymmetries can go unnoticed, needing attention<sup>17</sup>.

Regular audits are needed to improve the technical quality of the radiological examination, minimizing potential causes of false negatives<sup>18</sup>. All patients, despite having undergone previous mammography, were systematically submitted to a new mammography examination at the service, which adheres to strict radiological quality programs, being accredited by the Brazilian Society of Radiology and, more recently, having undergone an international audit.

The type of equipment used can influence radiological findings, thereby interfering with the addition of radiological assessment software. Computer-aided detection (CAD)<sup>19</sup> raises sensitivity by 10%, for example. Mammographic screening studies were performed using conventional mammography, but digital mammography allows better visualization, although it has not been shown to be superior in mammographic screening<sup>20</sup>. Also, it decreases the incidence of interval tumors<sup>21</sup>.

Two technologies are increasingly present in our daily lives: tomosynthesis<sup>19</sup>, which improves sensitivity mainly in dense breasts; and spectral mammography, which increases sensitivity and specificity in relation to digital mammography (86.2–94.1% versus 53.4–85.9%)<sup>22</sup>. In this study, all mammograms were analog, and the examinations were evaluated by three radiologists with experience in mammographic screening, which enhances the importance of the findings presented here. Double-reading mammographic evaluation and evaluation by a senior radiologist decrease the rates of false negatives, compared to simple reading. Double-reading minimizes potential errors in perception and interpretation. In this sense, there is discussion regarding the possibility of simple reading with tomosynthesis<sup>5</sup>, where the negative points would be the increase in radiation of the breast and the cost of the equipment.

Some radiological findings are associated with non-visualization of tumors on mammography, such as architectural distortion, asymmetries, unsuspected densities, anatomical location, lobular carcinoma, dense breast and lesion size<sup>3,23</sup>. In this study, the only factor that was associated with failure to identify the tumor was breast density.

Despite the small number of patients evaluated (n=85), we found a substantial number of mammograms with a

negative finding (20%), even after evaluation by experienced radiologists and examinations performed under appropriate technical conditions, with internal clinical quality control, which denotes the importance of including and valuing clinical findings and the patient's clinical history.

Currently, when discussing mammographic screening, patients should be aware of the pros and cons of mammographic screening, but we must stress that it needs to be performed in asymptomatic patients. Clinical examination increases the detection rate<sup>24</sup>, or minimizes negative radiological findings<sup>25</sup>. Symptomatic patients should seek out diagnostic services. Positive or doubtful clinical findings should warrant additional examinations, with ultrasound being an important complementary examination to be initially considered<sup>6</sup>. A study evaluating the potential reasons for non-visualization of tumors on mammography, given the identification of lesions by ultrasound, considered potential mammographic interpretation errors to be the presence of asymmetries, distortions and calcifications<sup>18</sup>.

As limitations of the study, the radiological examinations were performed using conventional mammography, but nowadays in Brazil, most mammography uses this equipment, which reinforces our findings.

In the United States, radiology is the eighth specialty associated with medical procedures, and it is often related to problems of perception or interpretation<sup>21</sup>. The dissemination of knowledge about the limitations of mammography and the improvement of the doctor-patient relationship can minimize potential factors that can limit the radiological examination.

Mammography is one of the main tests related to the decrease in breast cancer mortality, a fact that should be valued. Increasingly, the patient must be aware of the pros and cons of mammographic screening and the limitations of mammography<sup>1,2</sup>, in addition to the factors discussed in this article. Limitations should be part of the mammographic report, aiming at better knowledge on the part of the patient. Strict quality control, audited clinics and double reading can minimize the risk. This is associated with the presence of clinical history and clinical notes, which can influence the radiological report, and in the present study both were essential for the diagnosis of lesions not seen on mammography.

## CONCLUSION

Rigorous observation after the mammographic examination, through clinical history, physical examination and image reading, must be considered in the radiological report, with the aim of reducing false negative rates. In this study, high breast density was the greatest obstacle, highlighting the importance of examining secondary aspects. The presence of asymmetries, distortions, changes in skin thickness and involvement of lymph

nodes is a warning sign that should be considered important, even in the case of no description of clinical findings.

## AUTHORS' CONTRIBUTION

A.H.U.W.: conceptualization, data curation, formal analysis, funding investigation, methodology, project administration, supervision, validation.

M.M.S.: data curation, formal analysis, investigation, methodology.

B.E.F.C.: data curation, formal analysis, investigation, methodology.

R.A.C.V.: conceptualization, data curation, formal analysis, funding acquisition, investigation, project administration, resources, supervision.

All authors contribute to writing-original draft and performed writing-review & editing.

## REFERENCES







1. Loberg M, Lousdal ML, Bretthauer M, Kalager M. Benefits and harms of mammography screening. *Breast Cancer Res.* 2015;17(1):63. <http://doi.org/10.1186/s13058-015-0525-z>
2. Kopans DB. Arguments against mammography screening continue to be based on faulty science. *Oncologist.* 2014;19:107-12. <http://dx.doi.org/10.1634/theoncologist.2013-0184>
3. Kamal RM, Abdel Razek NM, Hassan MA, Shaalan MA. Missed breast carcinoma; why and how to avoid? *J Egypt Natl Canc Inst.* 2007;19(3):178-94.
4. Choi WJ, Cha JH, Kim HH, Shin HJ, Chae EY. Analysis of prior mammography with negative result in women with interval breast cancer. *Breast Cancer.* 2016;23(4):583-9. <https://doi.org/10.1007/s12282-015-0606-y>
5. Wadhwa A, Sullivan JR, Gonyo MB. Missed Breast Cancer: What Can We Learn? *Curr Probl Diagn Radiol.* 2016;45(6):402-19. <https://doi.org/10.1067/j.cpradiol.2016.03.001>
6. Majid AS, de Paredes ES, Doherty RD, Sharma NR, Salvador X. Missed breast carcinoma: pitfalls and pearls. *Radiographics.* 2003;23(4):881-95. <https://doi.org/10.1148/rg.234025083>
7. Vieira R, Formenton A, Bertolini SR. Breast cancer screening in Brazil. Barriers related to the health system. *Rev Assoc Med Bras.* 2017;63(5):466-74. <http://dx.doi.org/10.1590/1806-9282.63.05.466>
8. Vieira RA, Lourenço TS, Mauad EC, Moreira Filho VG, Peres SV, Silva TB, et al. Barriers related to non-adherence in a mammography breast-screening program during the implementation period in the interior of Sao Paulo State, Brazil. *J Epidemiol Glob Health.* 2015;5(3):211-9. <https://doi.org/10.1016/j.jegh.2014.09.007>
9. Lee BL, Liedke PE, Barrios CH, Simon SD, Finkelstein DM, Goss PE. Breast cancer in Brazil: present status and future goals. *Lancet Oncol.* 2012;13(3):e95-e102. [https://doi.org/10.1016/S1470-2045\(11\)70323-0](https://doi.org/10.1016/S1470-2045(11)70323-0)
10. Medeiros GC, Bergmann A, Aguiar SS, Thuler LC. [Determinants of the time between breast cancer diagnosis and initiation of treatment in Brazilian women]. *Cad Saúde Pública.* 2015;31(6):1269-82. <http://dx.doi.org/10.1590/0102-311X00048514>
11. George SA. Barriers to breast cancer screening: an integrative review. *Health Care Women Int.* 2000;21(1):53-65. <https://doi.org/10.1080/073993300245401>
12. Vieira RAM, Mauad EC, Zucca-Mattheus AG, Mattos JSC, Haikel Jr. RL, Bauab SP. Breast screening: beginning-middle-end. *Rev Bras Mastol.* 2010;20(2):92-7.
13. Bleicher RJ. Timing and Delays in Breast Cancer Evaluation and Treatment. *Ann Surg Oncol.* 2018;25(10):2829-38. <https://doi.org/10.1245/s10434-018-6615-2>
14. Tramonte MS, Silva PCS, Chubaci SR, Cordoba CCRC, Zucca-Matthes AG, Vieira RAC. Delay in diagnosis of breast cancer in a public oncologic hospital. *Medicina (Ribeirão Preto).* 2016;49(5):451-62. <http://dx.doi.org/10.11606/issn.2176-7262.v49i5p451-462>
15. Vieira IT, de Senna V, Harper PR, Shahani AK. Tumour doubling times and the length bias in breast cancer screening programmes. *Health Care Manag Sci.* 2011;14(2):203-11. <https://doi.org/10.1007/s10729-011-9156-9>
16. Watanabe AHU, Vieira RAC, Sabino SMPS, Zucca-Matthes AG. Interval cancer in breast cancer screening program. *Câncer de intervalo em rastreamento mamográfico.* *Rev Bras Mastol.* 2013;23(1):28-32.
17. Lekanidi K, Dilks P, Suaris T, Kennett S, Purushothaman H. Breast screening: What can the interval cancer review teach us? Are we perhaps being a bit too hard on ourselves? *Eur J Radiol.* 2017;94:13-5. <https://doi.org/10.1016/j.ejrad.2017.07.005>
18. Haq R, Lim YY, Maxwell AJ, Hurley E, Beetles U, Bundred S, et al. Digital breast tomosynthesis at screening assessment: are two views always necessary? *Br J Radiol.* 2015;88(1055):20150353. <https://doi.org/10.1259/bjr.20150353>
19. Ariaratnam NS, Little ST, Whitley MA, Ferguson K. Digital breast Tomosynthesis vacuum assisted biopsy for Tomosynthesis-detected Sonographically occult lesions. *Clin Imaging.* 2018;47:4-8. <https://doi.org/10.1016/j.clinimag.2017.08.002>
20. Skaane P. Studies comparing screen-film mammography and full-field digital mammography in breast cancer screening: updated review. *Acta Radiol.* 2009;50(1):3-14. <https://doi.org/10.1080/02841850802563269>



21. Harvey HB, Tomov E, Babayan A, Dwyer K, Boland S, Pandharipande PV, et al. Radiology Malpractice Claims in the United States From 2008 to 2012: Characteristics and Implications. *J Am Coll Radiol*. 2016;13(2):124-30. <https://doi.org/10.1016/j.jacr.2015.07.013>
22. Mori M, Akashi-Tanaka S, Suzuki S, Daniels MI, Watanabe C, Hirose M, et al. Diagnostic accuracy of contrast-enhanced spectral mammography in comparison to conventional full-field digital mammography in a population of women with dense breasts. *Breast Cancer*. 2017;24(1):104-10. <https://doi.org/10.1007/s12282-016-0681-8>
23. Bazzocchi M, Facecchia I, Zuiani C, Puglisi F, Di Loreto C, Smania S. [Diagnostic imaging of lobular carcinoma of the breast: mammographic, ultrasonographic and MR findings]. *Radiol Med*. 2000;100(6):436-43.
24. Bancej C, Decker K, Chiarelli A, Harrison M, Turner D, Brisson J. Contribution of clinical breast examination to mammography screening in the early detection of breast cancer. *J Med Screen*. 2003;10(1):16-21. <https://doi.org/10.1258/096914103321610761>
25. Mouchawar J, Taplin S, Ichikawa L, Barlow WE, Geiger AM, Weinmann S, et al. Late-stage breast cancer among women with recent negative screening mammography: do clinical encounters offer opportunity for earlier detection? *J Natl Cancer Inst Monogr*. 2005;(35):39-46. <https://doi.org/10.1093/jncimonographs/lgi036>



# Reconstruction options for locally advanced breast cancer cases and their impact on the quality of life

Anne Karoline Groth<sup>1\*</sup> , Alan Tibério Dalpiaz Irigoneh<sup>1</sup> , Stefanie Kurth<sup>1</sup> , Larissa Sydor Victor<sup>2</sup> ,  
Andre Luiz Bilieri Pazio<sup>2</sup> , Dayane Raquel de Paula<sup>2</sup> , Kátia Sheylla Malta Purim<sup>3</sup> 

## ABSTRACT

**Introduction:** Radical surgical procedures are indicated for part of the patients with locally advanced breast cancer (LABC). The improvement in the use of myocutaneous flaps allowed surgeons to perform extensive resections, a procedure that can be traumatic for women, leading to several biopsychosocial complications in a shortened survival. **Objectives:** This study aimed at understanding the effects of surgical treatment on the quality of survival of patients with guarded and unchanging prognosis. **Methodology:** The project was designed in two stages: review of medical records with a sample of 27 cases and face-to-face interviews with the administration of questionnaires in a sample of five cases among the remaining patients who underwent LABC surgery at Hospital Erasto Gaertner in Curitiba (PR). **Results:** On average, the answers obtained with the World Health Organization Quality of Life (WHOQOL-BREF) instrument were “regular” for physical, psychological, and environmental domains and “good” for the social relations domain. In the 12-item short-form survey (SF-12), the means were 45,125 points for the mental component and 40,875 points for the physical one. These values show the impact of advanced disease, hygienic surgery, and chest reconstruction on the quality of life of the patients, reflecting the biopsychosocial damage caused by LABC. **Conclusion:** The data reveal that LABC treatment is aggressive, but in patients with survival, the surgical treatment associated with chest reconstruction had surprisingly positive results in relation to quality of life.

**KEYWORDS:** Breast neoplasms; Quality of life; Humanization of assistance.

## INTRODUCTION

Considered a public health problem by the Ministry of Health, breast cancer is the most frequent malignancy among women both worldwide and in Brazil – without taking into account non-melanoma skin tumors. In Brazil, 59,700 new cases of breast cancer are estimated for each year of the 2018–2019 biennium, with an estimated risk of 56.33 cases per 100,000 women<sup>1</sup>.

The overall 5-year survival rate of breast cancer patients is 90%, according to the American Cancer Society. This number varies based on tumor staging. *In situ* tumors have a success rate close to 100%; in cases of disease with local involvement, this number drops to 85%; distant metastasis of the disease shows an even lower value: approximately 30%<sup>2,3</sup>. However, mortality is significantly higher in part of the patients with locally advanced breast cancer (LABC), and surgical treatment is often only palliative or hygienic<sup>4</sup>.

LABC is a heterogeneous group that includes large tumors (T3 or T4), extensive nodal disease (N2 or N3), which may or may not be metastatic, and inflammatory carcinomas.

The treatment of LABC involves radical and extensive surgery, with the removal of a symbolic organ that can affect women’s femininity and sexuality, leading to a series of psychological, social, and physical complications<sup>5</sup>.

The role of reconstruction surgery in the treatment of LABC and the patient’s satisfaction and quality of life are topics of growing interest. In the vast majority of cases, wide mastectomy is only possible thanks to the rotation of large muscle flaps, since there is not enough skin for the primary closure of mastectomy in LABC cases. These procedures allow the mastologist to perform extensive resections of large tumors that, in other times, would have been considered unresectable<sup>5,6</sup>. We underline that these procedures are chiefly chest wall reconstructions to cover extensive soft tissue lesions and not breast reconstructions<sup>7</sup>.

Since this group of patients has reduced survival and the surgical procedure is extensive, with a long postoperative recovery period, improving their quality of life after mastectomy and chest

<sup>1</sup>Universidade Positivo – Curitiba (PR), Brazil.

<sup>2</sup>Hospital Erasto Gaertner – Curitiba (PR), Brazil.

<sup>3</sup>Universidade Federal do Paraná – Curitiba (PR), Brazil.

\*Corresponding author: annegroth@gmail.com

Conflict of interests: nothing to declare.

Received on: 10/19/2019. Accepted on: 03/13/2020

wall reconstruction is very important. Therefore, the indication for oncologic resection should take into account the patient's quality of life.

Quality of life is a multifactorial concept that has been increasingly studied due to changes in health practices<sup>8</sup>. The World Health Organization (WHO) defines quality of life as "the individual's perception of his/her position in life in the context of the culture and value systems in which he/she lives and in relation to his/her goals, expectations, standards, and concerns"<sup>8</sup>. However, the literature on the analysis of quality of life in LABC cases is scarce.

## OBJECTIVE

This study aimed to describe a sample of patients who underwent LABC surgical treatment, the type of reconstruction, the complications, the disease-free interval, deaths, and objective parameters of perceived quality of life.

## METHODS

We analyzed all LABC patients submitted to post-treatment reconstruction at the Hospital Erasto Gaertner in Curitiba from 2014 to 2018. The Research Ethics Committee (REC) of the hospital approved this study. Patients with pathologies other than breast cancer were excluded.

The project was designed in two stages: initially, we reviewed the medical records of all cases; next, during the follow-up appointments in the plastic surgery service, the patients were invited to answer a questionnaire with the help of the researchers, who clarified any potential doubts during the reading of the questionnaire. We chose three instruments for this stage: a survey on sociodemographic, clinical, and therapeutic characteristics and aspects related to LABC surgery; a generic quality of life survey (12-item short-form survey – SF-12); and a generic quality of life survey developed by the World Health Organization (World Health Organization Quality of Life instrument – WHOQOL-BREF).

### WHOQOL-BREF module

The WHOQOL-BREF module is a questionnaire used in pathologies in which pain is a critical component. It consists of 26 questions with answers that follow a 5-point scale, and the higher the score, the better the quality of life. The instrument covers four domains: physical, psychological, social relations, and environment<sup>8,9</sup>.

### SF-12 Survey

The SF-12 is a general health questionnaire first published in 1995 as part of the Medical Outcomes Study (MOS). The SF-12 assesses eight different aspects which influence the Health-Related Quality of Life (HRQoL): physical function, physical aspect, pain, general health, vitality, social function, emotional aspect, and mental health<sup>10,11</sup>.

## RESULTS

We selected 27 women with LABC between 2014 and 2018. All patients were operated by both the breast service and the plastic surgery service at the same time. All of them underwent a modified radical mastectomy with immediate chest reconstruction.

The mean age of the patients was 49 years, ranging from 22 to 86 years (Table 1). The mean lesion size at the time of resection was 138 cm<sup>2</sup>, with the largest lesion measuring 30 cm × 30 cm (Table 2).

The predominant histological type was ductal carcinoma with 20 cases (74% of the sample), followed by spindle cell neoplasm and ductal-lobular carcinoma with two cases each, and sarcoma, adenoid cystic carcinoma, and malignant *phylloides* tumor with one case each. Regarding mastectomy laterality, two cases were bilateral, 17 were on the right side, and eight on the left (Table 1).

The staging showed 13 patients with distant metastases (48%), and, in these cases, the purpose of surgical resection was exclusively hygienic.

Regarding the immunohistochemical pattern, 15 patients had a triple-negative profile (estrogen receptor-, progesterone receptor-, and human epidermal growth factor receptor 2 – HER2-negative) (Table 3).

The most commonly used form of reconstruction was chest wall reconstruction with a fleur-de-lis latissimus dorsi flap in 12 cases, followed by the V-Y flap in 11 cases (Figures 1 and 2).

Chest reconstruction was predominantly performed using extensive latissimus dorsi flaps (92.5%), allowing a greater transference of back skin; among its variants, fleur-de-lis was the most used technique, with 12 cases (44.4%) (Figure 3); V-Y was the second most used technique, with 11 cases (40.7%); and island flap was used in two patients (7.4%). In addition to the latissimus dorsi technique, the transverse rectus abdominis myocutaneous (TRAM) flap was also used in two patients (7.4%) (Table 2).

All patients had complete primary closure of their donor area without needing skin grafting.

All cases were monitored after discharge. The most common complications were seroma and dehiscence (12 patients). Despite the extensive oncologic resection, 14 of the 27 patients progressed to distant metastasis and/or local recurrence (51.9%) until the time of data collection, and 15 died (55.5% mortality) (Chart 1), with a mean survival of 240.7 days.

Chemotherapy was the most used complementary, adjuvant, and neoadjuvant treatment; 20 patients benefited from this treatment, eight of whom received associated radiotherapy and two received associated radiotherapy and hormone therapy. Three patients received only radiotherapy, and four received no complementary treatment (Table 1).

No deaths were related to procedures, surgical site infections, or chest wall instability; all deaths were due to disease progression.

Regarding the quality of life survey, out of the 12 patients who survived, seven (58.3%) refused to participate due to advanced disease or exhaustion caused by the treatment. The researchers

invited the remaining five patients to answer questions about quality of life aspects after the chest reconstruction procedure.

The SF-12 survey was administered, resulting in two scores – one for the mental component, with an average of 40,875, and another for the physical component, with an average of 45,125.

Next, the researchers administered the WHOQOL-BREF instrument, specific for pathologies with significant pain component.

## DISCUSSION

Age stands out as the main known risk factor for breast cancer in women. The incidence of breast cancer increases significantly with age<sup>12</sup>; however, the disease tends to be more aggressive in younger women<sup>13</sup>. Our study found that 48% of LABC cases

occurred in under-50-year-old women, and 11% of the patients were younger than 35 years. The death rate in under-50-year-old women was 77%, against 21% in women aged 50 years or older. In the subgroup of women under 35 years of age, mortality was 100%. This fact confirms the epidemiological characteristic of breast cancer: the risk of developing the disease increases with time due to aging and exposure to carcinogens; on the other hand, lower age tends to be a factor of worse prognosis, especially in under-35-year-old women, as observed in our study<sup>12,13</sup>.

In 48% of the patients, the surgery was only hygienic and for pain control, as they already had distant metastases.

The surgical treatment for these advanced tumors consists of extensive radical mastectomy and large skin resections, leading to significant rib cage deformities and requiring

**Table 1.** General characteristics of locally advanced breast cancer (LABC) patients who underwent surgical treatment in the 2014–2018 period.

Case	Age	Tumor Type	Staging	Complementary Treatment	Recurrence	Death
1	22	Ductal Carcinoma	T4N0M0	CT	No	Yes
2	32	Ductal-lobular Carcinoma	T4N0M1	CT + RT	Yes	Yes
3	33	Ductal Carcinoma	T4N3M1	CT	Yes	Yes
4	36	Ductal Carcinoma	T4N1M0	CT + HT + RT	No	No
5	41	Spindle Cell Neoplasm	T4N0M1	No	No	Yes
6	41	Ductal Carcinoma	T4N0M0	CT	No	No
7	42	Ductal-lobular Carcinoma	T4N1M1	CT	Yes	Yes
8	42	Ductal Carcinoma	T4N2M1	CT + HT	No	Yes
9	43	Ductal Carcinoma	T4N1M1	CT	No	Yes
10	43	Spindle Cell Neoplasm	T4N0M0	RT	No	No
11	43	Ductal Carcinoma	T4N2M1	CT	Yes	Yes
12	44	Ductal Carcinoma	T4N3M1	CT + RT	No	Yes
13	46	Ductal Carcinoma	T4N2M1	CT	Yes	Yes
14	50	Malignant <i>Phyllodes</i> Tumor	T4N0M0	No	Yes	Yes
15	52	Pleomorphic Sarcoma	T4N0M0	CT	No	No
16	52	Ductal Carcinoma	T4N1M0	CT + RT	Yes	No
17	52	Ductal Carcinoma	T4N2M1	No	Yes	Yes
18	54	Ductal Carcinoma	T4N1M1	CT + RT	Yes	No
19	57	Ductal Carcinoma	T4N2M0	CT	No	No
20	57	Ductal Carcinoma	T4N3M1	CT + RT	Yes	Yes
21	58	Ductal Carcinoma	T4N0M0	CT + RT	No	No
22	61	Adenoid Cystic Carcinoma of the Breast	T4N0M0	RT	Yes	No
23	62	Ductal Carcinoma	T4N3M0	CT + RT	No	No
24	63	Ductal Carcinoma	T4N1M0	CT	Yes	Yes
25	66	Ductal Carcinoma	T4N0M0	No	No	No
26	68	Ductal Carcinoma	T4N2M1	CT + RT	Yes	Yes
27	86	Ductal Carcinoma	T4N2M0	RT	Yes	No

CT: chemotherapy; RT: radiotherapy; HT: hormone therapy.

**Table 2.** Surgical profile of patients submitted to surgical treatment for locally advanced breast cancer (LABC) in the 2014–2018 period.

Case	Reconstruction Method	Resection	Lesion area (cm <sup>2</sup> )	Lesion side	Complications
1	V-Y LD	R0	900	Right	No
2	Fleur-de-Lis LD	R0	170	Left	Necrosis + Dehiscence
3	TRAM	R0	45.5	Right	Dehiscence
4	V-Y LD	R1	144	Right	No
5	TRAM	R0	130	Left	Necrosis
6	Fleur-de-Lis LD	R0	42	Left	No
7	Fleur-de-Lis LD	R0	27.3	Right	No
8	V-Y LD	R0	90	Left	Seroma + Necrosis + Dehiscence
9	Fleur-de-Lis LD	R0	96	Right	Dehiscence
10	V-Y LD	R0	217	Right	No
11	Fleur-de-Lis LD	R1	225	Left	No
12	Fleur-de-Lis LD	R0	13.44	Left	Hematoma
13	Fleur-de-Lis LD	R0	67.6	Right	No
14	V-Y LD	R0	360	Right	No
15	Transverse Island LD	R0	140	Right	No
16	V-Y LD	R0	132	Right	No
17	V-Y LD	R1	84	Left	No
18	Fleur-de-Lis LD	R0	28	Right	Seroma + Dehiscence
19	V-Y LD	R0	90	Right	No
20	V-Y LD	R2	100	Right	No
21	V-Y LD	R0	102	Right	Seroma
22	Transverse Island LD	R0	77	Right	Dehiscence
23	Fleur-de-Lis LD	R0	7	Left	Dehiscence
24	V-Y LD	R0	85	Right	No
25	Fleur-de-Lis LD	R0	270	Right	Dehiscence
26	Fleur-de-Lis LD	R1	32.5	Left	Seroma
27	Fleur-de-Lis LD	R0	39	Right	No

LD: latissimus dorsi flap; TRAM: transverse rectus abdominis myocutaneous.



**Figure 1.** Right chest reconstruction with V-Y latissimus dorsi flap before and after radical mastectomy.

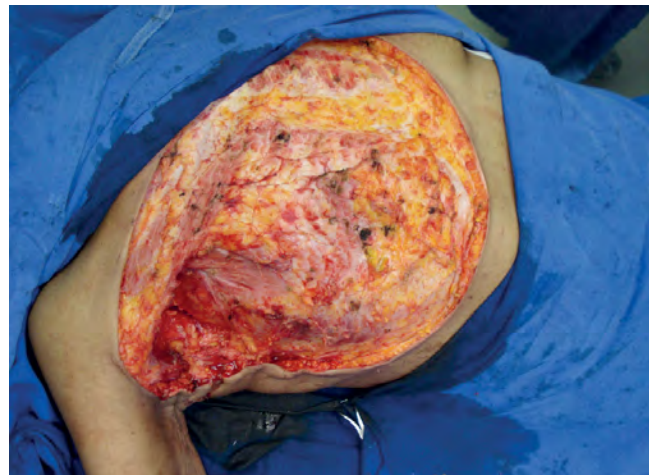

**Figure 2.** Intraoperative image of the right chest reconstruction with V-Y latissimus dorsi flap.

complex reconstructions<sup>14,15</sup>. The myocutaneous flap is the first option to cover the resulting chest wall deformities, as it allows adequate coverage of soft tissues with acceptable morbidity of the donor area. Guidelines recommend offering reconstruction to all breast cancer patients and performing it immediately in the service<sup>16</sup>.

Several forms of chest wall reconstruction can be employed for repairing defects after the resection of breast tumors. Particularly in these LABC cases, skin and soft tissue deficiencies are very extensive, requiring large flaps. The latissimus dorsi flap in its V-Y and fleur-de-lis variations can offer more tissue to these defects, with excellent blood supply<sup>17-19</sup>. The incidence of total complications per patient identified in our study was 44.4%. This finding is compatible with the literature<sup>20</sup>, especially in surgical wound complications, which can have a detrimental effect on the remaining treatment (delay in radiotherapy and chemotherapy).

In this study, all women were treated by the public health system (*Sistema Único de Saúde – SUS*) and were diagnosed at an advanced stage, perhaps due to the longer interval between suspicion and diagnostic confirmation and the lower frequency of mammograms performed compared to the private healthcare system. Nonetheless, we do not have sufficient data about the period from the diagnosis until the arrival at the reference hospital to confirm this hypothesis.

Concerning the quality of life, the BREAST-Q questionnaire is the best known and the most widely used in evaluations of breast surgeries, but we did not adopt it in our study because we performed chest reconstruction, not breast reconstruction. Therefore, we opted for the SF-12 and WHOQOL surveys.

Seven patients refused to participate in the interview, which corresponds to 58.3% of the survivors. They expressed negative feelings and aversion to returning to the hospital environment, associated with moments of distress and suffering caused by the disease.

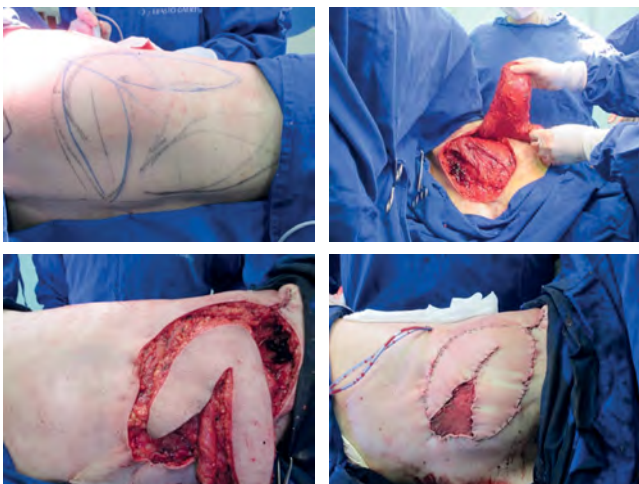
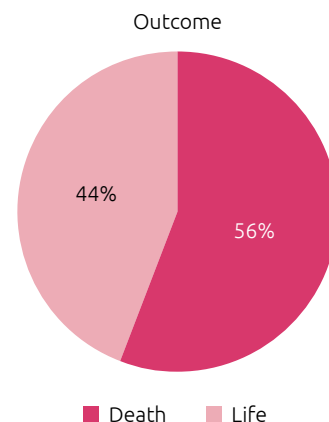

**Figure 3.** Radical mastectomy with chest reconstruction using the fleur-de-lis latissimus dorsi technique.

**Table 3.** Immunohistochemical profile of patients who underwent surgical treatment for locally advanced breast cancer (LABC) in the 2014–2018 period.

Case	PR	ER	HER2	KI67 (%)
1	NEG	NEG	NEG	30
2	NEG	NEG	NEG	80
3	POS	POS	NEG	30
4	NEG	NEG	POS	30
5	NEG	NEG	NEG	85
6	NEG	NEG	NEG	60
7	NEG	NEG	NEG	05
8	NEG	NEG	NEG	-
9	POS	POS	NEG	20
10	NEG	NEG	NEG	30
11	POS	POS	NEG	10
12	NEG	NEG	NEG	80
13	NEG	POS	NEG	67
14	POS	POS	POS	40
15	NEG	NEG	NEG	80
16	NEG	NEG	NEG	-
17	NEG	NEG	POS	50
18	NEG	NEG	POS	20
19	NEG	NEG	NEG	70
20	NEG	NEG	NEG	-
21	POS	POS	NEG	100
22	NEG	NEG	NEG	-
23	NEG	NEG	POS	35
24	NEG	NEG	NEG	-
25	NEG	NEG	NEG	90
26	POS	POS	POS	-
27	POS	POS	NEG	60

PR: progesterone receptors; ER: estrogen receptors; HER2: human epidermal growth factor receptor 2; NEG: negative; POS: positive; KI67: cancer cell proliferation marker.



**Chart 1.** Outcome of locally advanced breast cancer (LABC) patients submitted to surgical treatment in the 2014–2018 period, considering all deaths until data collection.

The patients who answered the surveys reported physical and emotional damages in the SF-12 survey concerning breast cancer treatment, which was expected given the length of the treatment.

As for the WHOQOL-BREF score, we identified loss in the physical domain, responsible for measuring pain and discomfort, energy and fatigue, and activities of daily living, as well as in the psychological domain. The social relations domain – personal relationships, social support, and sexual activity – was the most preserved and categorized as “good.” This result surprised us because our hypothesis was of loss in all aspects. This finding leads us to assume the surgery can be beneficial, mainly for the local control of the tumor and wound, allowing greater social interaction.

## CONCLUSION

LABC treatment is a challenge in several aspects: oncologic, reconstructive, and quality of life. Moreover, its high mortality also represents a challenge. In the sample analyzed in this study, mortality was 51.9%. Despite the large oncologic resections needed in these patients, several flaps can be used for chest wall reconstruction,

particularly the latissimus dorsi flap in its V-Y and fleur-de-lis variations, which is capable of closing extensive defects.

The quality of life assessment in this study was limited by the high mortality and the low adherence to the surveys, which restricted their interpretation. Nevertheless, we found signs of improvement in social relations. It is necessary to continue evaluating LABC patients to determine the benefit of such extensive surgery in this group.

## AUTHORS' CONTRIBUTIONS

A.K.G.: Conceptualization; Writing – review & editing; Supervision; Methodology; Project administration.

A.T.D.I.: Conceptualization; Writing – original draft; Data curation; Formal Analysis; Methodology; Project administration.

S.K.: Data curation; Formal Analysis.

L.S.V.: Investigation.

A.L.B.P.: Investigation; Resources.

D.R.P.: Investigation.

K.S.M.P.: Supervision.

## REFERENCES





- Santos M de O. Estimativa 2018: incidência de câncer no Brasil. *Rev Bras Cancerol* [Internet]. 2018 [acessado em 25 jul. 2018];64(1):119-20. Disponível em: [http://www1.inca.gov.br/rbc/n\\_64/v01/pdf/15-resenha-estimativa-2018-incidencia-de-cancer-no-brasil.pdf](http://www1.inca.gov.br/rbc/n_64/v01/pdf/15-resenha-estimativa-2018-incidencia-de-cancer-no-brasil.pdf)
- Siegel RL, Miller KD, Jemal A. Cancer Statistics, 2019. *CA Cancer J Clin* [Internet]. 2019 [acessado em 3 jan. 2020];69(1):7-34. Disponível em: <https://doi.org/10.3322/caac.21551>
- American Cancer Society. Cancer Facts & Figures 2019 [Internet]. American Cancer Society; 2019 [acessado em 3 jan. 2020]. 76 p. Disponível em: <https://www.cancer.org/content/dam/cancer-org/research/cancer-facts-and-statistics/annual-cancer-facts-and-figures/2019/cancer-facts-and-figures-2019.pdf>
- Tryfonidis K, Senkus E, Cardoso MJ, Cardoso F. Management of locally advanced breast cancer perspectives and future directions. *Nat Rev Clin Oncol* [Internet]. 2015 [acessado em 25 jan. 2020];12:147-62. <https://doi.org/10.1038/nrclinonc.2015.13>
- Ferraz AMN. Avaliação da qualidade de vida de mulheres mastectomizadas [dissertação] [Internet]. Porto Alegre: Universidade Federal do Rio Grande do Sul; 2009 [acessado em 25 jul. 2018]. Disponível em: <https://www.lume.ufrgs.br/bitstream/handle/10183/15929/000690879.pdf>
- Almeida RA de. Impacto da mastectomia na vida da mulher. *Rev SBPH* [Internet]. 2006 [acessado em 25 jul. 2018];9(2):99-113. Disponível em: [http://pepsic.bvsalud.org/scielo.php?script=sci\\_arttext&pid=S1516-08582006000200007&lng=pt&nrm=iso](http://pepsic.bvsalud.org/scielo.php?script=sci_arttext&pid=S1516-08582006000200007&lng=pt&nrm=iso)
- Tardy M, Beguinot M, Galvaing G, Emering C, Leboudec G, Filaire M. Breast cancer and chest wall surgery: a review. *J Chir Thorac Cardiovasc* [Internet]. 2019 [acessado em 25 jan. 2020];23(2):1-25. Disponível em: <https://doi.org/10.24399/JCTCV23-2-TAR>
- The WHOQOL Group. The World Health Organization quality of life assessment (WHOQOL): position paper from the World Health Organization. *Soc Sci Med* [Internet]. 1995 [acessado em 25 jan. 2020];41(10):1403-9. Disponível em: [https://doi.org/10.1016/0277-9536\(95\)00112-k](https://doi.org/10.1016/0277-9536(95)00112-k)
- Fleck M, Louzada S, Xavier M, Chachamovich E, Vieira G, Santos L, et al. Aplicação da versão em português do instrumento abreviado de avaliação da qualidade de vida “WHOQOL-BREF” application. *Rev Saúde Pública* [Internet]. 2000 [acessado em 25 jul. 2018];34(2):178-83. Disponível em: <http://www.revistas.usp.br/rsp/article/view/25001/26829>
- Ware JE, Keller SD, Kosinski M. How to score the SF12 physical and mental health summary scales the Health Institute. 2ª ed. Boston: New England Medical Center; 1995.
- Silveira MFS, Almeida JC, Freire RS, Haikal DS, Martins AEBL. Propriedades psicométricas do instrumento de avaliação da qualidade de vida: 12-Item Health Survey (SF-12). *Ciênc Saúde Coletiva* [Internet]. 2013 [acessado em 25 jul. 2018];18(7):1923-31. Disponível em: <https://doi.org/10.1590/S1413-81232013000700007>
- Momenimovahed Z, Salehiniya H. Epidemiological characteristics of and risk factors for breast cancer in the world. *Breast Cancer* [Internet]. 2019 [acessado em 10 fev. 2020];11:151-64. Disponível em: <https://doi.org/10.2147/BCTT.S176070>
- Nunes BAP, Siqueira SL, Pereira SM, Pacheco TJ, Pessanha TO, Mendonça SB. Perfil epidemiológico dos pacientes diagnosticados com câncer de mama em Campos dos Goytacazes (RJ), Brasil. *Rev Bras Mastologia* [Internet]. 2012 [acessado em 12 jun. 2019];22(4):117-23. Disponível em: [https://www.mastology.org/wp-content/uploads/2015/06/MAS\\_v22n4\\_117-123.pdf](https://www.mastology.org/wp-content/uploads/2015/06/MAS_v22n4_117-123.pdf)

14. Graziosi GB, Lucas FAS, Maximiano AMC, Caiado Neto BR, Prota Junior MLC. Reconstrução de parede torácica em tumores de mama localmente avançados. *Rev Bras Cir Plást* [Internet]. 2013 [acessado em 25 jul. 2018];28(3):64. Disponível em: <http://www.rbc.org.br/details/1346/reconstrucao-de-parede-toracica-em-tumores-de-mama-localmente-avancados>
15. Marcondes CA, Pessoa SGP, Pessoa BBGP, Dias IS, Ribeiro NP. Strategies for chest reconstruction following extensive resection of locally advanced breast tumors: an 11-case series. *Rev Bras Cir Plást* [Internet]. 2015 [acessado em 25 jul. 2018];30(3):339-44. Disponível em: <http://www.dx.doi.org/10.5935/2177-1235.2015RBCP0162>
16. Tanos G, Prousskaia E, Chow W, Angelaki A, Cirwan C, Hamed H, et al. Locally advanced breast cancer: autologous versus implant-based reconstruction. *Plast Reconstr Surg Global Open* [Internet]. 2016 [acessado em 25 jul. 2018];4(2):e622. Disponível em: <https://www.ncbi.nlm.nih.gov/pmc/articles/PMC4778893/> <https://dx.doi.org/10.1097%2FGOX.0000000000000598>
17. Weledji EP, Elong FA. Primary surgical treatment of locally advanced breast cancer in low resource settings. *Ann Med Surg* [Internet]. 2016 [acessado em 25 jul. 2018];12:5-7. Disponível em: <http://dx.doi.org/10.1016/j.amsu.2016.10.003>
18. Cardoso F, Costa A, Norton L, Cameron D, Cufer T, Fallowfield L, et al. 1st International consensus guidelines for advanced breast cancer (ABC 1). *Breast* [Internet]. 2012 [acessado em 25 jul. 2018];21(3):242-52. Disponível em: <https://doi.org/10.1016/j.breast.2012.03.003>
19. Aitken ME, Mustoe TA. Why change a good thing? Revisiting the fleur-de-lis reconstruction of the breast. *Plast Reconstr Surg* [Internet]. 2002 [acessado em 25 jul. 2018];109(2):525-33. <https://doi.org/10.1097/00006534-200202000-00018>
20. Warzelhan J, Stoelben E, Imdahl A, Hasse J. Results in surgery for primary and metastatic chest wall tumors. *Eur J Cardiothorac Surg*. 2001 [acessado em 25 jul. 2018];19(5):584-8. Disponível em: <https://www.ncbi.nlm.nih.gov/pubmed/11343936> [https://doi.org/10.1016/s1010-7940\(01\)00638-8](https://doi.org/10.1016/s1010-7940(01)00638-8)





# Association of mammography with sociodemographic and care factors in residents of Belo Horizonte, MG, Brazil

Amanda Silva Magalhães<sup>1\*</sup> , Bruno de Souza Moreira<sup>1</sup> , Dário Alves da Silva Costa<sup>1</sup> ,  
Amanda Cristina de Souza Andrade<sup>2</sup> , Waleska Teixeira Caiaffa<sup>1</sup> 

## ABSTRACT

**Objective:** This study aimed to investigate screening mammography in the last two years, sociodemographic factors, and healthcare service use among women aged 40–69 years living in a Brazilian urban center. **Methods:** The data are part of a household survey called “MOVE-SE Academias” (2014/2015) carried out in Belo Horizonte (MG). The sample was selected using a stratified three-stage cluster sampling: Health Academy Program units distributed in the city, census tracts, and households. Pearson’s chi-square test was used in the analysis. **Results:** Of the 371 women included in this study with a mean age of 52.5 years, 66.2% among those aged 40–49 years ( $n = 157$ ) and 75.7% among those aged 50–69 years ( $n = 214$ ) reported being submitted to mammography within two years before the interview. When it comes to women aged 40–49 and 50–69 years, a higher proportion was found among those with higher schooling ( $p = 0.011$  and  $p = 0.001$ ), who had been to medical appointments in less than one year ( $p = 0.024$  and  $p < 0.001$ ), who had performed the Pap smear test in less than two years ( $p < 0.001$  for both groups) and who reported having a private health insurance ( $p = 0.007$  and  $p = 0.008$ ). Higher family income was associated only with the performance of the screening exam among women aged 40–49 years ( $p = 0.006$ ). **Conclusion:** Our results suggest inequalities in access to health services for breast cancer screening, modulated by socioeconomic factors, including private health insurance. Prioritizing more vulnerable groups in cancer screening as a public policy can contribute to reducing health inequalities.

**KEYWORDS:** mammography; radiology; women’s health; health services; health status disparities; urban health.

## INTRODUCTION

Worldwide, breast cancer is more common among women and the leading cause of specific mortality in this group<sup>1</sup>. The estimates for 2020 are 1.97 million new cases of breast cancer and 622 thousand deaths from the disease worldwide<sup>2</sup>. In Brazil, the National Cancer Institute “José Alencar Gomes da Silva” estimated 66,280 new cases of breast cancer each year in the 2020–2022 triennium, corresponding to an estimated risk of 61.61 new cases per 100,000 women<sup>3</sup>. In 2017, approximately 17,000 deaths of women from breast cancer in the country were accounted for by the national mortality statistics available<sup>4</sup>. Expressive mortality from the disease is associated with high incidence and late diagnosis. Thus, early detection, a form of secondary prevention, is essential for reducing mortality, as it aims to identify cancer in early stages when prognosis is better<sup>5</sup>.

There are two strategies for the early detection of breast cancer: early diagnosis and screening<sup>6,7</sup>. Early diagnosis seeks to identify people with initial signs and/or symptoms of the disease, striving for quality, and ensuring comprehensive care in all stages of the care line<sup>5</sup>. This can contribute to reducing progression to subsequent stages<sup>8</sup>, in addition to increasing the chances of cure and enabling the use of less aggressive and systemic therapeutic forms, leading to a faster recovery and minimal sequelae<sup>9</sup>. The most accepted strategy for early diagnosis of breast cancer today is made up of a triad: population alert to suspicious signs and symptoms of cancer, health professionals trained to evaluate suspected cases, and health services prepared to ensure timely diagnostic confirmation and with quality<sup>7</sup>.

In turn, screening involves a systematic application of simple and easily performed tests on supposedly asymptomatic individuals (in the preclinical phase) to identify abnormalities

<sup>1</sup>Universidade Federal de Minas Gerais – Belo Horizonte (MG), Brazil.

<sup>2</sup>Universidade Federal de Mato Grosso – Cuiabá (MT), Brazil.

\*Corresponding author: amandasmagalhaes@hotmail.com

Conflict of interest: nothing to declare.

Received on: 03/09/2020. Accepted on: 05/13/2020.

suggestive of the disease<sup>6</sup>. The Ministry of Health recommends mammography for breast cancer screening<sup>7</sup> because it is a fast, non-invasive, and low-cost exam in comparison to other imaging exams. In addition, it is associated with acceptable side effects, brings reproducible results, and can be applied to the population at regular intervals and reasonable costs to society<sup>10</sup>. These advantages make mammography the method of choice for screening breast cancer on a large scale and at population levels.

The World Health Organization (WHO) recommends mammographic screening every two years for women over the age of 50, so as to cover more than 70% of this population<sup>11</sup>. In Brazil, the Ministry of Health recommends screening for breast cancer by mammography every two years for women aged between 50 and 69 years<sup>7</sup>, while the Brazilian Society of Mastology (SBM), the Brazilian College of Radiology and Diagnostic Imaging (CBR) and the Brazilian Federation of Gynecology and Obstetrics Associations (Febrasgo) suggest that it should be performed annually for women aged 40 years or older<sup>12</sup>. The criticism of these Brazilian medical societies about biennial screening in patients aged 50 years or older stems from tumors, in some women, tending to develop at an earlier age; therefore, screening at an older age and longer intervals between exams could result in diagnosis in more advanced stages<sup>12</sup>. In turn, the criticism of the recommendation that includes younger women and the short interval between exams concerns the negative balance between possible benefits and risks, such as greater exposure to ionizing radiation and problems associated with overdiagnosis and overtreatment<sup>13</sup>.

Despite advances in the field of women's health in the country, access to mammography still is not equal among Brazilian women, being marked by socioeconomic, racial, educational, and regional inequalities. Previous studies have reported that a higher level of education and income, white skin color, and living in an urban area or more developed regions of the country are associated with better adherence to mammography<sup>14-17</sup>. In addition, it was previously observed that women who consulted a physician in the last year and those who reported having private health insurance are more likely to undergo the exam<sup>15-17</sup>. Therefore, identifying the characteristics related to the mammography exam is extremely important to guide public health policies, so as to reduce inequalities in this area.

In view of the above, this study was conducted with the following objectives:

- to estimate the proportion of mammography exams performed in the last two years before the interview by women aged 40–49 and 50–69 years, living in a Brazilian urban center;
- to investigate the sociodemographic and health service use factors associated with mammography by age group.

## METHODS

### Study design and ethical aspects

This is a cross-sectional study based on information from a population-based household survey called Lifestyles and Health Project – Study on Health Academies and Similar in Brazilian Municipalities: from Understanding the Program to Effectiveness of Actions (MOVE-SE Academies), conducted by researchers from the Urban Health Observatory of Belo Horizonte, Universidade Federal de Minas Gerais.

“MOVE-SE Academies” was carried out in the nine health districts of Belo Horizonte (Minas Gerais) and aimed to evaluate the residents of the geographic surroundings of the Health Academy Program (PAS, acronym in Portuguese), including its users and non-users.

PAS was implemented in Belo Horizonte in 2006, preferably in areas of social vulnerability. This program operates in owned or shared public places and offers free physical activity classes supervised by physical educators, in addition to health promotion initiatives such as nutritional guidance and other community education activities for people over 18 years referred by the Basic Health Units (BHU) and also by spontaneous demand<sup>18,19</sup>.

Data were collected from the “MOVE-SE Academies” Project between November 2014 and March 2015, in face-to-face interviews using a standardized questionnaire that assessed topics related to the individual, home-related and neighborhood characteristics, as well as aspects related to participation in the PAS and health service use. More details about the “MOVE-SE Academies” can be obtained in a previous publication<sup>20</sup>.

The study was approved by the Research Ethics Committee of Universidade Federal de Minas Gerais under protocol no. 26152814.2.0000.5149, and all volunteers signed an informed consent form to participate in the study.

### Study sample

Sample selection of PAS non-users had a probabilistic design by clusters and was made in three stages: PAS poles, census sectors, and households.

Of the 63 poles of the program in the city of Belo Horizonte in 2014 that were included in the list of the Municipal Health Department, those with implementation until the first semester of 2013 and not directed to special groups (older adults and institutional workers) or located in specific points (universities, condominiums, and district markets) were considered eligible. Of the 44 eligible poles, 10 were randomly selected, three of which were inherited from a previous study<sup>20</sup>, with respective probability 1 of the census tracts where they were located.

The remaining census tracts were sampled around the poles with different probabilities and sample size proportional to the total number of tracts in the surroundings. Census tracts located up to 500 m from any pole were 2.4 times more likely to be drawn

compared to those located more than 500 m away. The households were selected using systematic sampling based on the number of households per census tract according to data from the 2010 census. In each household, an adult resident (18 years or older) was elected according to the quota established by sex and age group. With this strategy, the final sample of the study consisted of 1,376 respondents: 544 men and 832 women.

For the present study, we analyzed information of 378 women aged 40 to 69 years who were not PAS users and lived in the surroundings of where the program was conducted.

### Study variables

The dependent variable was the performance of mammography by women aged 40 years or older evaluated by the question “When was the last time you had a mammography exam?”. Answer options were: “less than a year”, “one year to less than two years”, “two years to less than three years”, “three years or more” and “never done it”. The responses were categorized as “performed” or “did not perform” mammography within the time frame of two years before the interview.

The independent variables were selected based on the literature<sup>8,15,16</sup> and grouped into two blocks: sociodemographic characteristics and health service use. The variables in the first block included: skin color (white and non-white), marital status (without a partner and with a partner), complete years of schooling (0–4, 5–8, 9–11, and  $\geq 12$  years), paid work (yes and no) and family income (<1, 1–2, and  $\geq 3$  minimum wages). The variables in the second block were: medical appointments, evaluated by the question “When was the last time that you consulted a physician?” (less than a year and more than a year); Pap smear test, evaluated by the question “When was the last time you had a preventive exam for cervical cancer?” (less than two years, two years or more, and never done it); use of BHU, measured by the question “In the last 12 months, how often did you go to a BHU (for appointments, physical therapy, prevention, vaccination, obtaining medicines, etc.)?” (often, occasionally, rarely, and never); and possession of a private health insurance (yes and no).

### Data analysis

A descriptive analysis of sociodemographic characteristics and variables related to health service use was carried out using absolute and relative frequency distribution (%) and applying the Pearson's  $\chi^2$  test to identify the variables associated with the mammography exam. All analyses were performed using the STATA statistical package, version 12.0 (StataCorp LP, College Station, United States). A 5% confidence level was adopted.

## RESULTS

Among 832 women interviewed, 378 were between 40 and 69 years and, therefore, were eligible for this study. Seven participants were

excluded due to the lack of information on the mammography exam, totaling 371 participants: 157 in the 40–49 age group and 214 in the 50–69 age group (Figure 1).

Table 1 lists the characteristics of the sample and shows the comparison between the percentages of the selected variables between participants who had and had not undergone mammography less than two years before the interview for the age groups 40–49 and 50–69 years. In both groups, most participants were non-white, had a partner, had had a medical appointment less than a year and Pap smear test less than two years before the interview, used BHU frequently, and did not have a private health insurance. In addition, in the 40–49 age group, most women had 9 to 11 years of schooling, had a paid work, and family income was below one minimum wage. In the 50–69 age group, most subjects had zero to four years of schooling, did not have a paid work, and family income was greater than or equal to three minimum wages.

A total of 104 (66.2%; 95%CI 58.4–73.2) and 162 (75.7%; 95%CI 69.5–81) participants had undergone mammography exam less than two years before the interview among women aged 40–49

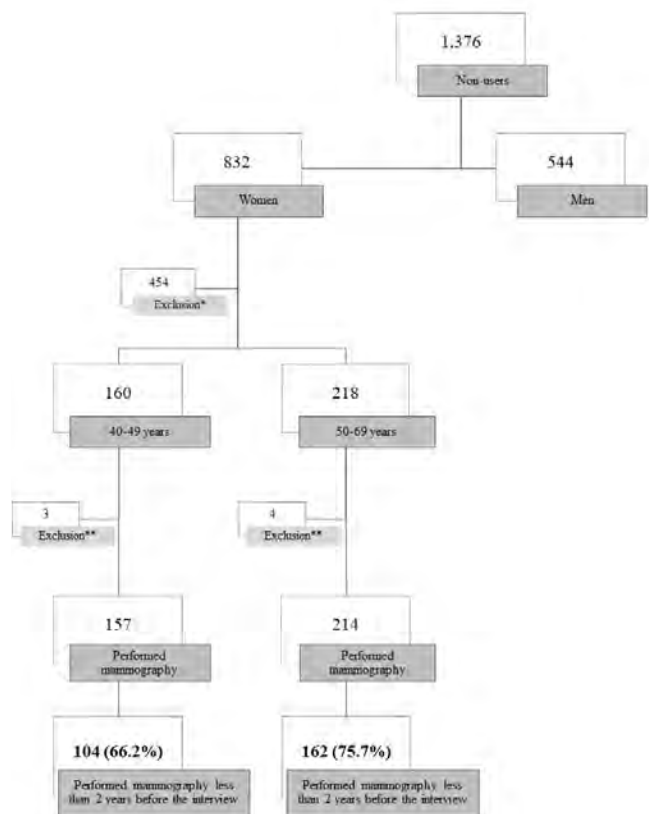

\*Other age groups; \*\*one missing datum related to mammography exam.

**Figure 1.** Flowchart showing the proportion of women who had undergone mammography less than two years before the interview for each age group. Belo Horizonte, Minas Gerais, Brazil, 2014–2015.

and 50–69 years, respectively. In both age groups, the variables significantly associated with the performance of mammography were: higher schooling level, medical appointment less than a year, the performance of Pap smear test less than two years, and

having private health insurance. Higher family income was also associated with having the exam among women aged 40–49 years.

As for the health service use among women who had undergone mammography exam less than two years before the interview,

**Table 1.** Mammography exam performed less than two years before the interview, sociodemographic characteristics, and health service use among women aged 40-49 and 50-69 years. Belo Horizonte, Minas Gerais, Brazil, 2014–2015.

Characteristics	40–49 years				50–69 years			
	Total (n = 157) n (%)	Mammography performed less than two years before the interview		p-value	Total (n = 214) n (%)	Mammography performed less than two years before the interview		p-value
		Yes (n = 104) n (%)	No (n = 53) n (%)			Yes (n = 162) n (%)	No (n = 52) n (%)	
<b>Sociodemographic</b>								
<i>Skin color*</i>								
White	54 (34.4)	41 (39.4)	13 (24.5)	0.063	70 (32.9)	56 (34.8)	14 (26.9)	0.294
Non-white	103 (65.6)	63 (60.6)	40 (75.5)		143 (67.1)	105 (65.2)	38 (73.1)	
<i>Marital status</i>								
Without a partner	51 (32.5)	31 (29.8)	20 (37.7)	0.316	101 (47.2)	72 (44.4)	29 (55.8)	0.155
With a partner	106 (67.5)	73 (70.2)	33 (62.3)		113 (52.8)	90 (55.6)	23 (44.2)	
<i>Complete schooling (years)</i>								
0–4	33 (21.0)	15 (14.4)	18 (34.0)	0.011	81 (37.8)	52 (32.1)	29 (55.8)	0.001
5–8	44 (28.0)	32 (30.8)	12 (22.6)		65 (30.4)	47 (29.0)	18 (34.6)	
9–11	67 (42.7)	45 (43.3)	22 (41.5)		45 (21.0)	42 (25.9)	3 (5.8)	
≥ 12	13 (8.3)	12 (11.5)	1 (1.9)		23 (10.8)	21 (13.0)	2 (3.8)	
<i>Paid work</i>								
No	73 (46.5)	48 (46.2)	25 (47.2)	0.904	128 (59.8)	98 (60.5)	30 (57.7)	0.72
Yes	84 (53.5)	56 (53.8)	28 (52.8)		86 (40.2)	64 (39.5)	22 (42.3)	
<i>Family income**,***</i>								
< 1 minimum wage	62 (39.7)	32 (31.0)	30 (56.6)	0.006	68 (32.8)	48 (30.8)	20 (39.2)	0.479
1–2 minimum wages	50 (32.1)	36 (35.0)	14 (26.4)		53 (25.6)	40 (25.6)	13 (25.5)	
≥ 3 minimum wages	44 (28.2)	35 (34.0)	9 (17.0)		86 (41.6)	68 (43.6)	18 (35.3)	
<b>Health service use</b>								
<i>Medical appointment</i>								
Less than one year	142 (90.5)	98 (94.2)	44 (83.0)	0.024	193 (90.6)	154 (95.1)	39 (76.5)	< 0.001
More than one year	15 (9.5)	6 (5.8)	9 (17.0)		20 (9.4)	8 (4.9)	12 (23.5)	
<i>Pap smear test</i>								
Less than two years	120 (76.4)	99 (95.2)	21 (39.6)	< 0.001	158 (74.2)	147 (90.8)	11 (21.6)	< 0.001
Two years or more	32 (20.4)	3 (2.9)	29 (54.7)		47 (22.1)	13 (8.0)	34 (66.7)	
Never done	5 (3.2)	2 (1.9)	3 (5.7)		8 (3.7)	2 (1.2)	6 (11.7)	
<i>Use of Basic Health Units</i>								
Often	55 (35.0)	39 (37.5)	16 (30.2)	0.235	89 (41.6)	69 (42.6)	20 (38.5)	0.453
Occasionally	40 (25.5)	27 (26.0)	13 (24.5)		63 (29.4)	45 (27.8)	18 (34.6)	
Rarely	33 (21.0)	17 (16.3)	16 (30.2)		30 (14.0)	21 (13.0)	9 (17.3)	
Never	29 (18.5)	21 (20.2)	8 (15.1)		32 (15.0)	27 (16.6)	5 (9.6)	
<i>Private health insurance</i>								
No	112 (71.3)	67 (64.4)	45 (84.9)	0.007	145 (67.8)	102 (63.0)	43 (82.7)	0.008
Yes	45 (28.7)	37 (35.6)	8 (15.1)		69 (32.2)	60 (37.0)	9 (17.3)	

\*one missing datum for this variable in the 50–69 age group; \*\*one missing datum for this variable in the 40–49 age group; \*\*\*seven missing data for this variable in the 50–69 age group.

the relationship between the frequency of use of BHU and private health insurance in both age groups was examined. As expected, a high percentage (> 70%) of participants without a private health insurance was found among subjects who reported using a BHU frequently in the last 12 months, in both age groups. There was also a high percentage (> 75%) of participants who had private health insurance among those who reported never having searched a BHU in the last 12 months, in both age groups. Specifically, in the 40–49 age group, it was observed that, among participants who frequently used BHU, 71.8% did not have a private health insurance, while among those who never searched a BHU, 76.2% had a private health insurance (Figure 2A). Likewise, in the 50–69 age group, it was found that, among interviewees who frequently used BHU, 79.7% reported not having a private health insurance and, among those who never searched a BHU, 77.8% reported having a private health coverage (Figure 2B).

## DISCUSSION

In the ages 40–49 and 50–69 years, 33% and 24% of women living in a Brazilian urban center, respectively, did not perform mammography in the last two years. Higher education, medical appointment, Pap smear test, and having a private health insurance were associated with a higher proportion of taking the exam in both age groups, while family income was only

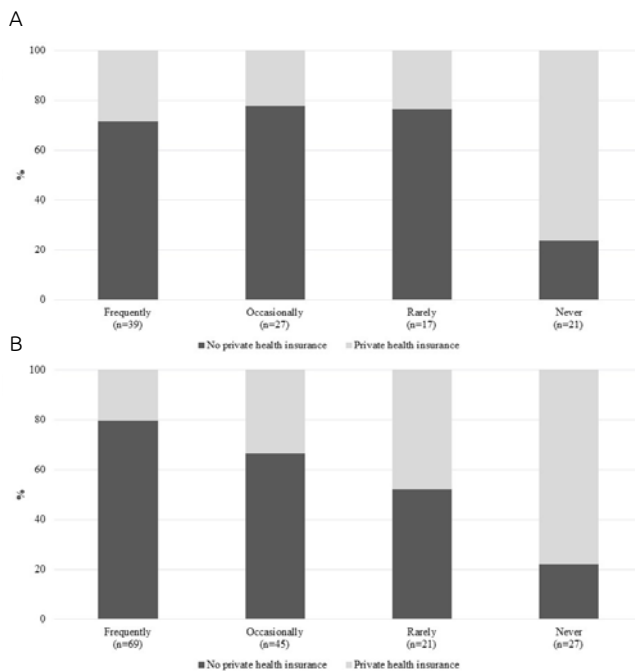

**Figure 2.** Percentage of private health insurance according to the use of Basic Health Units among women aged (A) 40–49 and (B) 50–69 years who underwent mammography less than two years before the interview. Belo Horizonte, Minas Gerais, Brazil, 2014–2015.

relevant for the group 40–49 years, with all comparisons being significant ( $p < 0.05$ ).

Proportions similar to those of our study were reported regarding mammography in the investigated age groups. In the National Household Sample Survey (PNAD, acronym in Portuguese) conducted in 2008, 67.7% of women in Brazil reported having undergone a mammography exam in the 40–49 age group<sup>14</sup>. In 2013 the prevalence of mammography performed in the last two years among women aged 50–69 years in Belo Horizonte was 77.5%, according to the National Health Survey<sup>17,21,22</sup>. It is important to note that this percentage has remained stable, with no upward tendency, considering that the first survey was conducted in 2008 and the second, in 2013, both prior to our study.

Several studies relate inequalities in access to mammography to socioeconomic factors, such as educational level and income<sup>14,16,17,22–24</sup>. The literature shows that the low education level is one of the main barriers faced in the screening of breast cancer<sup>14,16,17,22,23</sup>. More educated women have better access to health information and resources, which can contribute to the performance of mammography at recommended intervals<sup>15</sup>. Additionally, there was a higher percentage of women with higher income in the group that had performed mammography less than two years before the interview in the 40–49 age group, but not in the 50–69 age group. Previous studies have also observed greater access to mammography related to higher income, which is justified by the possibility of direct payment or even of being covered by a private health insurance<sup>14,24</sup>. The lack of association between income and mammography in women aged 50–69 years may stem from the fact that this is the target age group of the Ministry of Health's public policies for breast cancer screening, which cover all women of this age group, regardless of income.

Another aspect reported was the possibility of surveillance bias, which represents the tendency to look more carefully for an outcome in one of the comparisons groups<sup>25</sup>, as well as the finding that the medical appointments were associated with mammography exam less than two years before the interview in both age groups. Previous studies indicate that this variable can be an important predictor for the performance of mammography, but it can also be considered one of the first barriers faced for the examination<sup>14–17</sup>, as the lack of periodic medical appointments may indicate difficulty in accessing the health service and/or lack of self-health care in general<sup>26</sup>. Women who had not seen a physician less than a year before study have one-third of the chance of undergoing mammography when compared to women who had seen a physician less than a year before survey<sup>14,15</sup>. Therefore, expanding access to medical appointments can positively impact early detection of breast cancer. In the same direction, we found that the Pap smear test, an indicator of gynecological consultation, was significantly associated with the performance of mammography in both age groups, suggesting that the actions to prevent cervical and breast cancer, coordinated

by basic care and usually treated together, as part of preventive health care<sup>16,26</sup>, represent a line of comprehensive care for women.

As for coverage by a private health insurance, the significantly higher percentage of women who reported having a health insurance in the group that had undergone mammography less than two years before the interview compared to the group that did not, in both age groups, takes us to the discussion of the role of the private health insurance. Some studies have shown that individuals with private health coverage use health services more frequently when compared to those who use only the public health system<sup>16,17,27</sup>. In addition, having health insurance coverage is an important factor for better access to mammography reported in the literature<sup>26</sup>. Thus, it is plausible to infer that having a private health insurance may have contributed to the performance of mammography among the participants of our study, since health insurance users use health services more frequently, have more contact with health professionals, and are more commonly referred to exams, in addition to higher availability of mammography devices in the private sector<sup>28</sup>. Although no significant association was found between the use of BHU and the performance of mammography in both age groups, when relating this variable to affiliation with a private health insurance in the group that had undergone mammography less than two years before the interview, most women who frequently used BHU did not have a private health insurance and, among those who never attended BHU, most had one. These results suggest the existence of two main ways of accessing the mammography in the municipality. For women who use primary care regularly, this exam is strongly influenced by the public health system, while for women who do not use primary care, the exam has a greater influence on supplementary health, that is, the private sector.

We also investigated women who did not perform mammography, stratified for two years to less than three years, three years or more, and those who never performed it. In the 40–49 and 50–69 age groups, 21% and 3.3% of participants had never been subjected to mammography, respectively. This important percentage of not performance of the exam in the younger age group is disquieting since a previous study reported that Brazilian women in the age group less than or equal to 40 years represented 17% of breast cancer cases with unfavorable clinicopathological characteristics<sup>29</sup>. On the other hand, the lowest percentage of failure to perform the exam among women aged 50–69 years suggests a strong impact of Brazilian public policies for breast cancer screening, which prioritize this age group.

A current discussion on screening for breast cancer by mammography is the definition of age for the exam. In Brazil, according to the Clinical Guidelines for the Control of Breast Cancer, the target age range of 50–69 years was established<sup>5,7,17</sup>. However, according to SBM, CBR, and Febrasgo, the recommendation of screening women with usual population risk involves annual mammography in the age group of 40–74 years<sup>12,15</sup>.

Brazilian clinical guidelines are similar to international recommendations such as those of the United States Preventive Services Task Force (USPSTF)<sup>30</sup> and the Canadian Task Force on Preventive Health Care (CTFPHC)<sup>31</sup>. Per the USPSTF, biennial screening is indicated for women aged 50 to 74 years, and the decision to start screening mammography in women before 50 years must be individual<sup>30</sup>. In turn, the CTFPHC recommends screening for women aged 40–49 years as non-routine screening and, for women aged 50–69 years, as routine, that is, every 2–3 years<sup>31</sup>.

Previous scientific evidence points out that the balance between benefits and risks of mammographic screening is still more favorable in women aged 50–69 years without a family history of breast cancer<sup>32,33</sup>; however, there is evidence that mammographic screening in 40–49 years women significantly reduces the risk of breast cancer mortality<sup>34,35</sup>. Given this scenario, the age for mammographic screening in Brazil must be debated, because of the increasing incidence of breast cancer cases and the significant mortality rate (26%) in women over 75 years<sup>12</sup>.

It is important to highlight that breast cancer screening depends a lot on primary care, as this is the level of health care at which the clinical breast exam is performed, as well as the request for mammography for the target population and the follow-up of the patient to evaluate results. Subsequently, the patient's approach involves the use of units of secondary complexity for mammography and other complementary exams, in addition to units of high complexity in the presence of a neoplasm. Therefore, it is essential to develop coordinated actions that cross the levels of strategies: from prevention, early detection, and timely treatment to palliative care<sup>36</sup>. However, inequalities in the distribution of resources and barriers in the flow of assistance in the health network when it comes to radiological exams can hinder a timely and accurate diagnosis, consequently increasing mortality and morbidity from breast cancer<sup>7,37,38</sup>.

As well as the socioeconomic aspects and the indicators of health service use, the uneven geographical distribution of mammography devices is also considered an important indicator of health inequality<sup>28</sup>. Previous studies point out that the inadequate distribution of this equipment contributes to the increasing inequality in access to services providing mammography<sup>22,27,29</sup>. According to Ramos et al., although there is a sufficient number of devices to cover the population, they are unevenly distributed across the country, which is accompanied by a reduced operational capacity<sup>28</sup>. In this context, the development of further studies that investigate the inequalities in the screening of breast cancer under the perspective of the spatial distribution of mammographs between different health districts of the city of Belo Horizonte would be suitable, since this information was not collected in the population survey.

This study has some limitations that must be taken into account. First, data were collected in-home interviews, so information about mammography screening was obtained

by self-report. Thus, the memory bias to report when the last mammography exam was performed, and the information bias related to answers considered socially accepted may underestimate or overestimate our estimates. Second, the small sample size may have compromised the statistical power of the study to reveal significant associations. Finally, the study design prevents any conclusions about the chronology and causality of associations found. On the other hand, this study investigated several potential factors that could influence the performance of the mammography exam. Another strong point is that the “MOVE-SE Academias” Project included residents from all health districts of Belo Horizonte, thus representing the entire municipality. Thus, the sample consisted of participants with well-diversified characteristics in social, economic, and health terms.

## CONCLUSION

The results showed that the proportion of mammography exams performed in a Brazilian urban center, even with a stable tendency compared to other studies, that is, without an increase over time, exceeded the goal recommended by the WHO in the age group of 50-69 years, despite the inequalities observed in screening for breast cancer for both sociodemographic characteristics and health service use. This finding is worrying, considering that mammography is an exam with great potential for early diagnosis. Thus, the analysis of inequalities in access to health services related to screening for breast cancer is an important element to be taken into account in the formulation of public policies aimed at promoting and preventing health problems for women.

## ACKNOWLEDGMENTS

We would like to thank the Urban Health Observatory of Belo Horizonte (OSUBH) and all the researchers who contributed with this work; the Coordination for the Improvement of Higher Education Personnel (CAPES) for the postdoctoral scholarship from researcher Bruno de Souza Moreira; the National Council for Scientific and Technological Development (CNPq), for the partial financial support for the project (CNPq no. 552752/2011-8), and the research productivity scholarship from researcher Waleska Teixeira Caiaffa. In particular, to professors Deborah Carvalho Malta, from the Universidade Federal de Minas Gerais, and Pedro Rodrigues Curi Hallal, from the Universidade Federal de Pelotas, for their relevant participation in the process of financing with CNPq.

## AUTHORS' CONTRIBUTION

A.S.M.: Conceptualization, investigation, methodology, formal analysis, validation, visualization, writing of original draft, and writing – review and editing.

B.S.M.: Conceptualization, investigation, methodology, validation, visualization, writing of original draft, and writing – review and editing.

D.A.S.C.: Research, data curation, formal analysis, validation, visualization, and writing – review and editing.

A.C.S.A.: Conceptualization, investigation, methodology, data curation, formal analysis, supervision, validation, visualization, and writing – review and editing.

W.T.C.: Fundraising, project management, conceptualization, research, methodology, supervision, validation, visualization, and writing – review and editing.

## REFERENCES

1. Akram M, Iqbal M, Daniyal M, Khan AU. Awareness and current knowledge of breast cancer. *Biol Res.* 2017;50(1):33. <https://doi.org/10.1186/s40659-017-0140-9>
2. Bray F, Ferlay J, Soerjomataram I, Siegel RL, Torre LA, Jemal A. Global cancer statistics 2018: GLOBOCAN estimates of incidence and mortality worldwide for 36 cancers in 185 countries. *CA Cancer J Clin.* 2018;68(6):394-424. <https://doi.org/10.3322/caac.21492>
3. Instituto Nacional de Câncer José Alencar Gomes da Silva. Estimativa 2020: incidência de câncer no Brasil. Rio de Janeiro: INCA; 2019.
4. Brasil. Ministério da Saúde. DATASUS. Estatísticas Vitais. Sistema de Informações sobre Mortalidade - SIM [Internet]. Brasília: Ministério de Saúde; 2017 [Accessed on Feb 9, 2020]. Available at: <http://tabnet.datasus.gov.br/cgi/tabcgi.exe?sim/cnv/obt10uf.def>
5. Instituto Nacional de Câncer José Alencar Gomes da Silva. Programa Nacional de Controle do Câncer de Mama. Rio de Janeiro: INCA; 2011.
6. Azevedo A, Ramos AL, Gonçalves V, Souza CF, Batista GS, Silva RBV, et al. O conhecimento de mulheres acerca do rastreamento do câncer de mama e suas implicações. *Rev Med.* 2019;98(3):187-93. <https://doi.org/10.11606/issn.1679-9836.v98i3p187-193>
7. Instituto Nacional de Câncer José Alencar Gomes da Silva. Diretrizes para a detecção precoce do câncer de mama no Brasil. Rio de Janeiro: INCA; 2015.
8. Buranello M, Meirelles MCCC, Walsh IAP, Pereira GA, Castro SS. Prática de exames de rastreio para câncer de mama e fatores associados – Inquérito de Saúde da Mulher em Uberaba MG, 2014. *Ciênc Saúde Colet.* 2018;23(8):2661-70. <http://dx.doi.org/10.1590/1413-81232018238.14762016>

9. Souza N, Falcão L, Nour G, Brito J, Castro M, Oliveira M. Breast cancer in young women: an epidemiological study in northeastern Brazil. *Sanare*. 2017;16(2):60-7.
10. Heywang-Köbrunner S, Hacker A, Sedlacek S. Breast care advantages and disadvantages of mammography screening. *Breast Care*. 2011;6(3):199-207. <https://doi.org/10.1159/000329005>
11. World Health Organization. Cancer control: knowledge into action: WHO guide for effective programmes. Module 3 Early Detection. WHO; 2007.
12. Urban L, Chala LF, Bauab SP, Schaefer M, Santos RP, Maranhão NMA, et al. Recomendações do Colégio Brasileiro de Radiologia e Diagnóstico por Imagem, da Sociedade Brasileira de Mastologia e da Federação Brasileira das Associações de Ginecologia e Obstetrícia para o rastreamento do câncer de mama. *Radiol Bras*. 2017;50(4):244-9. <http://dx.doi.org/10.1590/0100-3984.2017-0069>
13. Migowski A, Dias M, Nadanovsky P, Silva G, Sant'Ana D, Stein A. Diretrizes para detecção precoce do câncer de mama no Brasil. III – Desafios à implementação. *Cad Saúde Pública*. 2018;34(6):e00046317. <http://dx.doi.org/10.1590/0102-311x00046317>
14. Oliveira E, Pinheiro R, Melo E, Carvalho M. Condicionantes socioeconômicos e geográficos do acesso à mamografia no Brasil, 2003-2008. *Ciêns Saúde Colet*. 2011;16(9):3649-64. <http://dx.doi.org/10.1590/S1413-81232011001000002>
15. Schneider I, Giehl M, Boing A, D'Orsi E. Rastreamento mamográfico do câncer de mama no Sul do Brasil e fatores associados: estudo de base populacional. *Cad Saúde Pública*. 2014;30(9):1987-97. <http://dx.doi.org/10.1590/0102-311X00162313>
16. Lima-Costa MF, Matos DL. Prevalência e fatores associados à realização da mamografia na faixa etária de 50-69 anos: um estudo baseado na Pesquisa Nacional por Amostra de Domicílios (2003). *Cad Saúde Pública*. 2007;23(7):1665-73. <http://dx.doi.org/10.1590/S0102-311X2007000700018>
17. Silva G, Souza-Júnior P, Damascena G, Szwarzwald C. Detecção precoce do câncer de mama no Brasil: dados da Pesquisa Nacional de Saúde, 2013. *Rev Saúde Pública*. 2017;51(Supl. 1):1-9. <https://doi.org/10.1590/S1518-8787.2017051000191>
18. Lopes M, Caiaffa W, Andrade A, Malta D, Barber S, Friche A, et al. Disparities in food consumption between economically segregated urban neighbourhoods. *Public Health Nutr*. 2020;23(3):525-37. <https://doi.org/10.1017/S1368980019003501>
19. Fernandes A, Andrade A, Costa D, Dias M, Malta D, Caiaffa W. Programa Academias da Saúde e a promoção da atividade física na cidade: a experiência de Belo Horizonte, MG, Brasil. *Ciêns Saúde Colet*. 2017;22(12):3903-14. <http://dx.doi.org/10.1590/1413-812320172212.25282017>
20. Fernandes A, Andrade A, Ramos C, Friche A, Dias M, Xavier C, et al. Atividade física de lazer no território das Academias da Cidade, Belo Horizonte, Minas Gerais, Brasil: o efeito da presença de um programa de promoção da saúde na comunidade. *Cad Saúde Pública*. 2015;31(Supl. 1):1-13. <http://dx.doi.org/10.1590/0102-311X00104514>
21. Brasil. Ministério da Saúde. Pesquisa Nacional de Saúde [Internet]. 2013 [Accessed on: Dec 14, 2019]. Available at: <http://tabnet.datasus.gov.br/cgi/deftohtm.exe?pns/pnskb.def>
22. Melo E, Oliveira E, Chor D, Carvalho M, Pinheiro R. Inequalities in socioeconomic status and race and the odds of undergoing a mammogram in Brazil. *Int J Equity Health*. 2016;15:144. <https://dx.doi.org/10.1186/s12939-016-0435-4>
23. Relecom A, Arzel B, Perneger T. Effect of an organised screening program on socioeconomic inequalities in mammography practice, knowledge and attitudes. *Int J Equity Health*. 2018;17(1):95. <https://doi.org/10.1186/s12939-018-0811-3>
24. Ryerson A, Miller J, Ehemann C, Leadbetter S, White M. Recent trends in U.S. mammography use from 2000-2006: a population-based analysis. *Prev Med*. 2008;47(5):477-82. <https://doi.org/10.1016/j.ypmed.2008.06.010>
25. Guyatt G, Rennie D, Meade MO, Cook DJ. *Diretrizes para utilização da literatura médica: fundamentos para prática clínica da medicina baseada em evidências*. 2ª ed. Porto Alegre: Artmed; 2011.
26. Barbosa Y, Oliveira A, Rabêlo P, Silva F, Santos A. Fatores associados à não realização de mamografia: Pesquisa Nacional de Saúde, 2013. *Rev Bras Epidemiol*. 2019;22:1-13. <https://doi.org/10.1590/1980-5497201900069>
27. Theme Filha M, Leal M, Oliveira E, Esteves-Pereira A, Gama S. Regional and social inequalities in the performance of Pap test and screening mammography and their correlation with lifestyle: Brazilian national health survey, 2013. *Int J Equity Health*. 2016;15(1):1-8. <https://doi.org/10.1186/s12939-016-0430-9>
28. Ramos A, Alves L, Berra T, Popolin M, Arcoverde M, Campoy L, et al. Estratégia Saúde da Família, saúde suplementar e desigualdade no acesso à mamografia no Brasil. *Rev Panam Salud Publica*. 2018;42:1-9. <https://doi.org/10.26633/RPSP.2018.166>
29. Franzoi MA, Rosa DD, Zaffaroni F, Werutsky G, Simon S, Bines J, et al. Advanced stage at diagnosis and worse clinicopathologic features in young women with breast cancer in Brazil: a subanalysis of the AMAZONA III study (GBECAM 0115). *J Glob Oncol*. 2019;5:1-10. <https://doi.org/10.1200/jgo.19.00263>
30. Siu AL. Screening for breast cancer: U.S. Preventive services task force recommendation statement. *Ann Intern Med*. 2016;164(4):279-96. <https://doi.org/10.7326/M15-2886>
31. Barbeau P, Stevens A, Beck A, Skidmore B, Arnaout A, Brackstone M, et al. Breast cancer screening: protocol for an evidence report to inform an update of the Canadian Task Force on Preventive Health Care 2011 Guidelines. Ottawa Evidence Review Synthesis Centre; 2017. 66 p.
32. Sardanelli F, Aase HS, Álvarez M, Azavedo E, Baarslag HJ, Balleyguier C, et al. Position paper on screening for breast cancer by the European Society of Breast Imaging (EUSOBI) and 30 national breast radiology bodies from Austria, Belgium, Bosnia and Herzegovina, Bulgaria, Croatia, Czech Republic, Denmark, Estonia, Finland, France, Germany, Greece, Hungary, Iceland, Ireland, Italy, Israel, Lithuania, Moldova, The Netherlands, Norway, Poland, Portugal, Romania, Serbia, Slovakia, Spain, Sweden, Switzerland and Turkey. *Eur Radiol*. 2017;27(7):2737-43. <https://doi.org/10.1007/s00330-016-4612-z>
33. Secretan BL, Scoccianti C, Loomis D, Benbrahim-Tallaa L, Bouvard V, Bianchini F, et al. Special Report Breast-Cancer Screening — Viewpoint of the IARC Working Group. *N Engl J Med*. 2015;372(24):2353-8. <https://doi.org/10.1056/nejmsr1504363>
34. Moss SM, Wale C, Smith R, Evans A, Cuckle H, Duffy SW. Effect of mammographic screening from age 40 years on breast cancer mortality in the UK Age trial at 17 years' follow-up: A randomised controlled trial. *Lancet Oncol*. 2015;16(9):1123-32. [https://doi.org/10.1016/S1470-2045\(15\)00128-X](https://doi.org/10.1016/S1470-2045(15)00128-X)



35. Hellquist BN, Duffy SW, Abdsaleh S, Björneld L, Bordás P, Tabár L, et al. Effectiveness of population-based service screening with mammography for women ages 40 to 49 years. *Cancer*. 2011;117(4):714-22. <https://doi.org/10.1002/cncr.25650>
36. Traldi M, Galvão P, Morais S, Fonseca M. Demora no diagnóstico de câncer de mama de mulheres atendidas no Sistema Público de Saúde. *Cad Saúde Coletiva*. 2016;24(2):185-91. <https://doi.org/10.1590/1414-462X201600020026>
37. Thompson M, Lipson J, Daniel B, Harrigal C, Mullarkey P, Pal S, et al. Why are patients noncompliant with follow-up recommendations after MRI-guided core needle biopsy of suspicious breast lesions?. *Am J Roentgenol*. 2013;201(6):1391-400. <https://doi.org/10.2214/ajr.12.10282>
38. Medlen K, Leahy N, Greene-Donnelly K, Fleishon H, Jiménez P. Better use of available radiology resources for women's health in Latin America and the Caribbean. *Rev Panam Salud Publica*. 2018;42:e115. <https://doi.org/10.26633/rpsp.2018.115>



# Stages of breast reconstruction and quality of life after breast cancer

Aline Fernanda Fontinele Murici<sup>1</sup> , Ângela Ferreira Barros<sup>1\*</sup> 

## ABSTRACT

**Objective:** To evaluate which stage of breast reconstruction promotes improved quality of life for women treated for breast cancer, and to verify the socioeconomic and clinical factors associated with better quality of life. **Methods:** A cross-sectional study was conducted with 70 women treated for breast cancer in the perioperative period of late breast reconstruction in the Federal District. To assess quality of life, the Functional Assessment of Cancer Therapy — Breast (FACT-B) instrument was used. **Results:** Half of the women were under 50 years old. Tumor removal surgery had occurred on average 5.4 years ago. Women with axillary dissection had greater impairment in the physical well-being domain ( $p=0.001$ ) and the breast cancer subscale ( $p=0.016$ ). Among women who had undergone surgery more than one year previously, there were higher domains of emotional ( $p=0.006$ ) and functional ( $p=0.003$ ) well-being. Women who underwent breast reconstruction had higher values in the social/family well-being ( $p<0.001$ ), emotional well-being ( $p=0.001$ ), functional well-being ( $p=0.001$ ), and breast cancer subscale ( $p=0.005$ ) domains; and on the FACT-B score ( $p<0.001$ ), right after the first stage. **Conclusions:** Breast reconstruction favored better quality of life from the first stage, suggesting that this therapeutic modality should be offered promptly, whenever possible, and guaranteed for all women treated for breast cancer.

**KEYWORDS:** breast neoplasms; mammoplasty; mastectomy; quality of life.

## INTRODUCTION

In Brazil, breast cancer is the most common type of cancer among women, accounting for 29.5% of cases in 2018, and excluding cases of non-melanoma skin cancer<sup>1</sup>. In most women, the diagnosis occurs in advanced stages<sup>2</sup>, which implies the need to use more aggressive treatments with a greater impact on the quality of life of women affected by the disease.

Surgical treatment with total or partial removal of breasts and axillary lymph nodes is an effective method to eradicate the tumor, however, it is a mutilating procedure, as it removes organs that are a symbol of femininity for women, and can provide a negative effect on their quality of life<sup>3</sup>.

To counteract these effects, breast reconstruction in Brazil has been increased by the Public Health System<sup>4</sup>, with the aim of improving the quality of life of women undergoing surgical treatment for breast cancer. As such, the goal is to establish body aesthetics and improve women's self-image by restoring the volume lost in their breast with cancer and recreating the symmetry with the contralateral breast<sup>3</sup>.

Some studies have found an association between breast reconstruction and better quality of life<sup>5</sup>, both for immediate and late reconstruction in prospective analysis<sup>6</sup>. On the other hand, breast reconstruction can occur at various times. Thus, the entire reconstruction process can take months or years, and it is not clear from studies that assess quality of life how each step interferes with quality of life<sup>7</sup>.

Therefore, the objectives of this study are to assess which stage of breast reconstruction promotes an improvement in the quality of life of women treated for breast cancer and to verify the socioeconomic and clinical factors associated with better quality of life.

## METHODS

An analytical and cross-sectional study was carried out using a quantitative approach, with women who underwent breast cancer treatment and who were undergoing perioperative breast reconstruction at the plastic surgery outpatient clinic of the

<sup>1</sup>State Health Department of the Federal District— Brasília (DF), Brazil.

\*Corresponding author: anbarros@yahoo.com.br

Conflict of interests: Nothing to declare.

Received on: 08/23/2019. Accepted on: 06/25/2020.

Regional Hospital of Asa Norte, of the State Health Department of the Federal District (*Secretaria de Estado de Saúde do Distrito Federal* – SES/DF), Brasília, Federal District. This hospital is a reference in plastic surgery at the SES/DF.

These women were referred to this service by mastologists and/or oncologists after the surgical procedure for breast cancer removal and chemotherapy and/or radiotherapy treatments, as indicated for each case. Some still underwent hormone therapy, which did not prevent breast reconstruction. In addition, they presented no evidence of the disease and had good clinical conditions to either start the reconstruction or go through another stage of reconstruction, for those who had already undergone the first phase of immediate reconstruction.

Inclusion criteria were: having undergone surgical treatment for breast cancer, having physical and mental conditions that allowed them to communicate with the researcher and consent to participate in the research. The exclusion criteria were difficulties in communicating and not agreeing to participate in the research.

The data collection consisted of applying two questionnaires. The first addressed socioeconomic and clinical conditions. The second addressed quality of life through Functional Assessment of Cancer Therapy - Breast (FACT-B), version 4. It is a specific questionnaire for breast cancer patients. It is easy to administer and has been validated in Brazil, showing good internal consistency, high reliability and good reproducibility rates<sup>8</sup>.

Data collection was carried out from June to December 2015. Women were approached while they were waiting for care at the breast reconstruction plastic surgery outpatient clinic of the referred hospital. Those who underwent immediate reconstruction at the same time as tumor removal surgery were considered to have at least one reconstruction stage already performed.

The research was approved by the Research Ethics Committee of the Education and Research Foundation in Health Sciences of SES/DF (opinion n° 1076842) with respect to Resolution n° 466/2012, of the National Health Council.

For data analysis, a descriptive analysis was initially performed, with measures of central tendency and dispersion for quantitative variables and percentage distribution for qualitative variables. Then, in the results of each domain and FACT-B scale, the Kolmogorov-Smirnov test was applied, which indicated the normal distribution of the sample in each of them, except in the emotional well-being domain. Thus, the Student's *t* test was used to verify association with socioeconomic and clinical characteristics, except for this last domain, for which the Mann-Whitney U test was used. Statistical significance was set at  $p < 0.05$ . The analysis was performed using the Statistical Package for the Social Sciences (SPSS) software, version 20.0.

## RESULTS

The sample consisted of 70 patients. The women had a average age of 51.8 years old, standard deviation (SD)=9.1, and the majority were between 40 and 49 years old. Half of the women were married (50%), the average number of children they had was 2.4 (SD=1.3), the majority lived in the Federal District (75.7%), in their own home (81.4%), with an average of 3.2 (SD=1.1) residents in the home and an average family income of R\$ 2,492 (SD=2,183.5). Most self-declared themselves to be light-skinned black (57.1%), had completed high school (40%) and had been on sick leave due to the illness (38.6%) (Table 1).

Regarding clinical data, non-conservative breast surgery was the most prevalent (81.4%), as well as axillary dissection (67.1%). The tumor removal surgery had occurred, on average, 5.4 years beforehand (SD=4.9) (Table 2).

The participants were originally referred from tertiary hospitals (38.6%), from the hospital where they awaited late breast reconstruction (31.4%), from other public hospitals in the FD (22.9%) or from hospitals in other states (7.1%).

The functional well-being domain was the most compromised, with an average of 19.3 (SD=4.8). The breast cancer subscale was the most favorable, with a average of 24.8 (SD=6.3) (Table 3).

Tables 4 and 5 show the results of the association of clinical characteristics with the domains and scores of the FACT-B questionnaire.

Regarding the type of surgery (conservative or non-conservative), there was no statistically significant association with the domains and scores. In view of this result, we decided to analyze the other variables considering all the women in the sample, not excluding those who underwent conservative surgery.

Women who underwent axillary dissection had greater impairment in the physical well-being ( $p=0.001$ ) and the breast cancer subscale ( $p=0.016$ ) domains. The same could be observed in the scores, in which the women who underwent axillary dissection had lower values in the Trial Outcome Index (TOI), that is, in the sum of the following subscales: physical well-being, functional well-being and breast cancer ( $p=0.031$ ).

Among women for whom more than one year of surgery had passed, there were greater domains of emotional ( $p=0.006$ ) and functional well-being ( $p=0.003$ ). In the evaluation of the scores, no association of this variable was observed.

Women with at least one stage of breast reconstruction had higher values in the social/family well-being ( $p<0.001$ ), emotional well-being ( $p=0.001$ ), functional well-being ( $p=0.001$ ) and breast cancer subscales ( $p=0.005$ ). Similarly, an association between at least one stage of breast reconstruction and the FACT-B scores was observed, with higher averages: FACT-B TOI ( $p=0.002$ ), FACT-G ( $p<0.001$ ), FACT-B Total ( $p<0.001$ ).

Higher statistically significant averages of the domains and scores were found in women who had already undergone

the first stage of breast reconstruction compared to those who had not undergone any stage, except in the physical well-being domain. No statistically significant differences were

identified in the averages of the domains and scores beyond the first stage, as additional stages of breast reconstruction were performed.

**Table 1.** Distribution of socioeconomic and demographic characteristics of women in perioperative breast reconstruction in the plastic surgery outpatient clinic of Hospital Regional da Asa Norte (HRAN), Brasília, Federal District, between June and December 2015 (N=70).

Variable	Categories	N	%
Age group	Younger than 40 years old	5	7.1
	Between 40 and 49 years old	30	42.9
	Between 50 and 59 years old	19	27.1
	60 years old or older	16	22.9
Residency	Federal District	53	75.7
	Outside the Federal District	17	24.3
Skin color	White	21	30.0
	Dark-skinned or light-skinned black	49	70.0
Marital status	Married or common-law married	35	50.0
	Single/separated/divorced/widowed	35	50.0
Education level	Completed elementary education	29	41.4
	Completed high school education	31	44.3
	Completed higher education	10	14.3
Occupation	Retired/Receives a pension	15	21.4
	Housewife	4	5.7
	Salaried or self-employed	21	30.0
	Unemployed	3	4.3
	On sick leave	27	38.6

**Table 2.** Distribution of clinical and surgical characteristics of women in perioperative breast reconstruction in the plastic surgery outpatient clinic of Hospital Regional da Asa Norte (HRAN), Brasília, Federal District, between June and December 2015 (N=70).

Variable	Categories	N	%
Surgery type	Conservative	13	18.6
	Not conservative	57	81.4
Axillary dissection	Yes	47	67.1
	No	23	32.9
Chemotherapy	Yes	55	78.6
	No	15	21.4
Radiotherapy	Yes	52	74.3
	No	18	25.7
Hormonal therapy	Yes	27	38.6
	No	43	61.4
Time since tumor	Less than a year	12	17.1
Removal surgery	Between one and five years previously	26	37.2
	Longer than five years previously	32	45.7
Stage of breast reconstruction	None	27	38.6
	Stage 1	18	25.7
	Stage 2	09	12.9
	Further than stage 2	16	22.8

**Table 3.** Distribution of the results of the domains and scores of the Functional Assessment of Cancer Therapy - Breast (FACT-B) instrument according to the responses of women in perioperative breast reconstruction in the plastic surgery outpatient clinic of Hospital Regional da Asa Norte (HRAN), Brasília, Federal District, between June and December 2015.

		Average	Median	Standard deviation	Minimum	Maximum
Domains	Physical wellbeing	21.9	23.0	4.4	13.0	28.0
	Social/family well-being	19.7	21.0	4.9	3.0	27.0
	Emotional well-Being	20.0	21.0	3.6	7.0	24.0
	Functional well-being	19.3	19.0	4.8	6.0	28.0
	Breast cancer subscale	24.8	25.0	6.3	12.0	37.0
Scores	FACT-B TOI	66.0	66.0	12.6	38.0	93.0
	FACT-G TOTAL	81.0	81.7	13.1	44.0	106.0
	FACT-B TOTAL	105.7	106.5	17.6	56.0	143.0

TOI: Trial Outcome Index; FACT-G: Functional Assessment of Cancer Therapy – General.

**Table 4.** Relationship between the domains of the Functional Assessment of Cancer Therapy - Breast (FACT-B) questionnaire with the variables referring to socioeconomic and clinical data. Brasília, Federal District, 2015.

	Physical wellbeing	Social/family well-being	Emotional Well-Being	Functional well-being	Breast cancer subscale
	Average (SD)	Average (SD)	Average (SD)	Average (SD)	Average (SD)
Axillary dissection	20.8 (4.3)	20.2 (4.3)	20.0 (3.6)	19.4 (4.0)	23.5 (5.7)
No axillary dissection	24.3 (3.9)	18.8 (5.9)	19.9 (3.6)	19.0 (6.1)	27.3 (6.6)
p-value	<b>0.001*</b>	0.291*	0.980**	0.752*	<b>0.016*</b>
≤ 1 year since surgery	22.8 (3.6)	19.1 (4.8)	17.8 (3.2)	15.7 (4.9)	24.9 (± 4.7)
> 1 year since surgery	21.8 (4.6)	19.9 (4.9)	20.4 (3.5)	20.0 (4.4)	24.7 (6.6)
p-value	0.494*	0.615*	<b>0.006**</b>	<b>0.003*</b>	0.924*
Underwent reconstruction	22.4 (4.4)	21.3 (3.8)	21.1 (2.6)	20.7 (4.6)	26.4 (6.1)
Did not undergo reconstruction	21.2 (4.6)	17.1 (5.3)	18.1 (4.1)	16.9 (4.2)	22.1 (5.6)
p-value	0.262*	<b>&lt; 0.001*</b>	<b>0.001**</b>	<b>0.001*</b>	<b>0.005*</b>
No reconstruction stage	21.2 (4.6)	17.1 (5.3)	18.1 (4.1)	16.9 (4.2)	22.1 (5.6)
1 stage of reconstruction	23.2 (3.6)	21.4 (3.7)	21.5 (2.7)	20.3 (4.9)	26.9 (5.7)
p-value	0.129*	<b>0.005*</b>	<b>0.004**</b>	<b>0.019*</b>	<b>0.008*</b>

SD: standard deviation; \* Student *t* test; \*\* non-parametric test (Mann-Whitney U test).

**Table 5.** Relationship between the scores of the Functional Assessment of Cancer Therapy - Breast (FACT-B) questionnaire and the variables referring to socioeconomic and clinical data. Brasília, Federal District, 2015.

	FACT-B TOI	FACT-G TOTAL SCORE	FACT-B TOTAL SCORE
	Average (SD)	Average (SD)	Average (SD)
Axillary dissection	63.7 (11.6)	80.3 (11.3)	103.9 (15.5)
No axillary dissection	70.6 (13.6)	82.3 (16.3)	109.6 (21.1)
p-value*	<b>0.031</b>	0.567	0.200
≤ 1 year since surgery	63.3 (9.4)	75.2 (11.8)	100.2 (13.2)
> 1 year since surgery	66.5 (13.2)	82.2 (13.1)	106.9 (18.2)
p-value*	0.432	0.095	0.228
Underwent reconstruction	69.5 (11.9)	85.7 (10.4)	112.2 (14.7)
Did not undergo reconstruction	60.3 (11.7)	73.4 (13.4)	95.5 (17.2)
p-value*	<b>0.002</b>	<b>&lt; 0.001</b>	<b>&lt; 0.001</b>
No reconstruction stage	60.3 (11.7)	73.4 (13.4)	95.5 (17.2)
1 stage of reconstruction	70.3 (10.1)	86.7 (10.2)	113.6 (13.4)
p-value*	<b>0.005</b>	<b>0.001</b>	<b>0.001</b>

TOI: Trial Outcome Index; SD: standard deviation; \*Student *t* test.

There were no statistical associations between the domains and scores with the other variables in the socioeconomic and clinical questionnaire: age group, origin, skin color, marital status, education, occupation and types of treatment.

## DISCUSSION

The women treated for breast cancer participating in the present study had a higher quality of life according to the domains and scores of the FACT-B instrument, when compared to a previous study<sup>9</sup>, except in the social/family well-being domain. They presented a higher quality of life, mainly those who underwent breast reconstruction right after the first stage, corroborating the results of another study<sup>7</sup>.

As for the time since the tumor removal surgery, many women in the present study had had this surgery performed more than five years before. This is partly due to the selection of women in the perioperative period of breast reconstruction. As such, the women were evaluated after the end of the most aggressive breast cancer treatments, were in good general condition and had no signs of recurrence. This condition in itself favors a better quality of life compared to patients in other phases of treatment.

In the present study, the surgical procedure for having removed the tumor over a year before showed a statistical association with greater emotional and functional well-being. In a French study, quality of life after breast cancer surgery took one year to return to the same preoperative level<sup>10</sup>.

Regarding where the referral came from of the women interviewed, approximately 70% of them came from the hospital itself or from tertiary care services. Thus, it is worth questioning whether breast reconstruction has been offered to patients treated at other health services in the Federal District or if there are difficulties in accessing the specialized breast reconstruction clinic. Results of a national study<sup>4</sup> with data from the Public Health System indicate that, between 2008 and 2014, the number of breast reconstructions was still insufficient to meet the entire demand, when taking into account the number of mastectomies performed. Even so, there has been a significant increase in breast reconstructions over the years.

Thus, breast reconstruction has increasingly assumed a central role in the treatment of breast cancer. For women, reconstruction is understood as the effectiveness and success of breast cancer treatment, as it fills the gap left on their body and helps them to overcome the suffering triggered by the disease<sup>11</sup>.

Women undergoing breast reconstruction have a better quality of life in the psychological and social relations domains<sup>3</sup>. A similar result was observed in the present study, in which the women who underwent reconstruction presented higher averages in the social/family, emotional and functional domains, when compared to those who did not.

There was no influence of breast reconstruction from the point of view of physical well-being in the present study. This can be justified by the implications of the reconstruction itself, which involves extensive tissue manipulation, causing physical discomfort and mobility changes that can also be caused by sequelae resulting from breast removal surgery. Some authors also found no significant differences in quality of life related to physical aspects in women undergoing breast reconstruction<sup>3</sup>.

However, a significant association was found between axillary dissection and worse averages in the domains of physical well-being and breast cancer subscale, as well as in the TOI score, which is closely linked to physical aspects and breast cancer in the present study. This association probably occurs because of complications resulting from this procedure, which can cause pain, lymphedema, decreased arm mobility and muscle weakness. In a Chinese study, a worse average was also achieved in the breast cancer subscale in women who had undergone axillary dissection<sup>12</sup>.

Emotional function, which is considered to be a fundamental element of quality of life, showed a higher average in patients who had undergone breast reconstruction or at least the first stage, as observed in another study<sup>7</sup>. This reinforces the benefits of breast reconstruction. Another study showed better quality of life in women who underwent immediate breast reconstruction compared to those who underwent late reconstruction<sup>6</sup>.

Thus, breast reconstruction provided a better quality of life for women treated for breast cancer from the first stage, suggesting that this therapeutic modality should be offered more quickly and be guaranteed to all patients treated for this disease, in order to improve their quality of life more quickly.

A limitation of the study is the reduced sample size of women. More time for data collection was required to reach a greater number of women eligible to participate in the study.

Further studies on the quality of life of this population are suggested to support the strengthening of management strategies that increase material and human resources for more availability of breast reconstruction, especially at the same time as surgical treatment, when technical conditions exist.

## ACKNOWLEDGMENTS

This work was carried out with support from the School of Health Sciences (*Escola Superior em Ciências da Saúde - ESCS*).

## AUTHORS' CONTRIBUTIONS













A.M. and A.B.: Design, acquisition of funding, investigation, methodology, formal analysis, project administration, supervision, validation, visualization, writing — reviewing & editing.

## REFERENCES

1. Instituto Nacional de Câncer José Alencar Gomes da Silva. Coordenação de Prevenção e Vigilância. Estimativa 2018: Incidência de Câncer no Brasil. Rio de Janeiro: INCA; 2017.
2. Abrahão KS, Bergmann A, Aguiar SS, Thuler LCS. Determinants of advanced stage presentation of breast cancer in 87,969 Brazilian women. *Maturitas* [Internet]. 2015 [accessed on Aug 29, 2018];82(4):365-70. Available at: <https://www.sciencedirect.com/science/article/pii/S037851221530027X>. <http://doi.org/10.1016/j.maturitas.2015.07.021>
3. Paredes CG, Pessoa SGP, Peixoto DTT, Amorim DN, Araújo JS, Barreto PRA. The impact of breast reconstruction on the quality of life of patients after mastectomy at the Plastic Surgery Service of Walter Cantídio University Hospital. *Rev Bras Cir Plást* [Internet]. 2013 [accessed on Aug 2, 2019];28(1):100-4. Available at: [http://www.scielo.br/pdf/rbcp/v28n1/en\\_17.pdf](http://www.scielo.br/pdf/rbcp/v28n1/en_17.pdf). <https://doi.org/10.1590/S1983-51752013000100017>
4. Freitas-Júnior R, Gagliato DM, Moura Filho JWC, Gouveia PA, Rahal RMS, Paulinelli RR, et al. Trends in breast cancer surgery at Brazil's public health system. *J Surg Oncol* [Internet]. 2017 [accessed on Aug 2, 2019];115(5):544-9. Available at: <https://onlinelibrary.wiley.com/doi/full/10.1002/jso.24572>. <https://doi.org/10.1002/jso.24572>
5. Fanakidou I, Zyga S, Alikari V, Tsironi M, Stathoulis J, Theofilou P. Mental health, loneliness, and illness perception outcomes in quality of life among young breast cancer patients after mastectomy: the role of breast reconstruction. *Qual Life Res* [Internet]. 2018 [accessed on Aug 2, 2019];27(2):539-43. Available at: <https://link.springer.com/article/10.1007%2Fs11136-017-1735-x>. <https://doi.org/10.1007/s11136-017-1735-x>
6. Zhong T, Hu J, Bagher S, Vo A, O'Neill AC, Butler K, et al. A comparison of psychological response, body image, sexuality, and quality of life between immediate and delayed autologous tissue breast reconstruction: a prospective long-term outcome study. *Plast Reconstr Surg* [Internet]. 2016 [accessed on Aug 2, 2019];138(4):772-80. Available at: <https://insights.ovid.com/pubmed?pmid=27673514>. <https://doi.org/10.1097/PRS.0000000000002536>
7. Teo I, Reece GP, Christie IC, Guindani M, Markey MK, Heinberg LJ, et al. Body image and quality of life of breast cancer patients: influence of timing and stage of breast reconstruction. *Psychooncology* [Internet]. 2016 [accessed on Aug 2, 2019];25(9):1106-12. Available at: <https://onlinelibrary.wiley.com/doi/full/10.1002/pon.3952>. <https://doi.org/10.1002/pon.3952>
8. Michels FAZ, Latorre MRDO, Maciel MS. Validity and reliability of the FACT-B+4 quality of life questionnaire specific for breast cancer and comparison of IBCSG, EORTC-BR23 and FACT-B+4 questionnaires. *Cad Saúde Colet*. 2012;20(3):321-8.
9. Türk KE, Yılmaz M. The effect on quality of life and body image of mastectomy among breast cancer survivors. *Eur J Breast Health* [Internet]. 2018 [accessed on Aug 2, 2019];14(4):205-10. Available at: <https://www.ncbi.nlm.nih.gov/pmc/articles/PMC6170016/pdf/ejbh-14-4-205.pdf>. <https://doi.org/10.5152/ejbh.2018.3875>
10. Dauplat J, Kwiatkowski F, Rouanet P, Delay E, Clough K, Verhaeghe JL, et al. Quality of life after mastectomy with or without immediate breast reconstruction. *Br J Surg* [Internet]. 2017 [accessed on Aug 2, 2019];104(9):1197-1206. Available at: <https://onlinelibrary.wiley.com/doi/full/10.1002/bjs.10537>. <https://doi.org/10.1002/bjs.10537>
11. Inocenti A, Santos MA, Loyola EAC, Magalhães PAP, Panobianco MS. Impact of the effects of the reconstructive surgery in the life of women with breast cancer. *Texto Contexto Enferm* [Internet]. 2016 [accessed on Aug 2, 2019];25(2):e4520014. Available at: <http://www.scielo.br/pdf/tce/v25n2/0104-0707-tce-25-02-2016004520014.pdf>. <http://dx.doi.org/10.1590/0104-07072016004520014>
12. Yeo W, Mo FK, Pang E, Suen JJ, Koh J, Yip CH, et al. Quality of life of young Chinese breast cancer patients after adjuvant chemotherapy. *Cancer Manag Res* [Internet]. 2018 [accessed on Aug 2, 2019];10:383-9. Available at: <https://www.ncbi.nlm.nih.gov/pmc/articles/PMC5826245/pdf/cmar-10-383.pdf>. <https://dx.doi.org/10.2147%2FCMAR.S149983>



# Accuracy of ultrasound-guided core-needle biopsy confronted with pathological findings and comparison of its costs with vacuum-assisted biopsy's costs

Rozan El-Mafarjeh<sup>1</sup> , Marina Sonagli<sup>1\*</sup> , Marina de Paula Canal<sup>1</sup> , Eugênio César Rocha Santos Filho<sup>1</sup> , Camila Souza Guatelli<sup>1</sup> , Silvana Soares Santos<sup>1</sup> , Luciana Graziano<sup>1</sup> , Renato Cagnacci Neto<sup>1</sup> , Juliana Souza<sup>1</sup> , Tábata Alves Domingos<sup>1</sup> , Vinícius Fernando Calsavara<sup>1</sup> , Almir Galvão Vieira Bitencourt<sup>1</sup> , Fabiana Baroni Alves Makdissi<sup>1</sup> 

## ABSTRACT

**Introduction:** Breast cancer screening has enhanced early-stage diagnosis by detection of impalpable tumors which require histopathological evaluation. Main percutaneous biopsy types are core-needle biopsy (CNB) and vacuum-assisted biopsy (VAB). CNB is less invasive and related to less bleeding and pain. VAB allows larger tissue samples and permits metal clip placement in biopsy bed for posterior localization in case of surgery. Access to VAB is restricted in Brazil due to its high costs. **Objectives:** To evaluate the agreement between pathological results of ultrasound (US) guided CNB with metal clip placement and surgery and settle false negative rates (FNR), sensibility, specificity, and accuracy of this method, for breast lesions < 20 mm. **Methods:** 388 US-guided CNB were retrospectively reviewed. **Results:** Surgical excision was performed in 317 patients. Overall FNR was 9.8%, (5.2% for lesions 10–20 mm), sensibility 90.2% (94.8% for lesions 10–20 mm), specificity 94.9% (94.1% for lesions 10–20 mm), and accuracy 91.1% (94.7% for lesions 10–20 mm). Cost of VAB varies from 2.2 to 12.5 times US-guided CNB. With metal clip placement, VAB costs 1.95 to 5.2 times US-guided CNB. **Conclusions:** For lesions that can be identified in US, CNB with metal clip placement has high sensitivity, specificity, and accuracy, as well as low FNR.

**KEYWORDS:** core needle biopsy; breast tumor; image-guided biopsy; clip; breast carcinoma.

## INTRODUCTION

Breast cancer (BC) incidence is rising in low-income and middle-income countries due to improvement in life expectancy, urbanization, and adoption of Western lifestyles<sup>1,2</sup>. In the context of breast screening programs, detection of small and non-palpable lesions is increasing<sup>3</sup>. Suspicious lesions require histopathological evaluation and percutaneous breast biopsy has become an alternative to open surgical biopsy in these cases<sup>3</sup>. The main types of percutaneous breast biopsy are core-needle biopsy (CNB)<sup>3</sup> and vacuum assisted biopsy (VAB)<sup>4</sup>. CNB is less invasive and related to less bleeding and less pain, since it uses a thinner needle. VAB allows larger tissue samples through a single skin puncture without need to repeatedly relocate the needle when a tethered device is used<sup>3,4</sup>.

Studies have reported false-negative rates (FNR) of 1.1%–3.3% for CNB and 0.6%–3.5% for VAB<sup>4</sup>. In small lesions, percutaneous

biopsies, especially VAB, can completely remove the lesion. Inserting of a metal clip into the biopsy bed is necessary for subsequent identification of the area to be resected in the event of surgery<sup>5</sup>. In clinical practice, placement of a metal clip is routinely done in VAB but not in CNB. In A.C. Camargo Cancer Center, since 2012, it has been our preference to place a metal clip in selected CNB cases, especially when there is a higher suspicion for malignancies<sup>6</sup>.

The health system organization in Brazil is based on two financial sources: the public health system and the private system, composed by health insurances or self-funding<sup>1</sup>. Approximately 75% of the population has access only to public health care<sup>7</sup>. The Brazilian public health system and some health insurers do not provide access to VAB due to costs. It is estimated that costs associated to VAB are ten times higher than standard CNB<sup>8</sup>.

<sup>1</sup>A.C. Camargo Cancer Center – São Paulo (SP), Brazil.

\*Corresponding author: marina.sonagli@accamargo.org.br

Conflict of interests: nothing to declare.

Received on: 01/16/2020. Accepted on: 05/06/2020.



The objective of this study is to evaluate pathological diagnosis of ultrasound (US) guided CNB and surgery, setting false-negative rate, sensibility, specificity, accuracy, positive predictive value (PPV), negative predictive value (NPV), upgrading rate and agreement rate of US guided CNB for breast lesions smaller than 2 cm. Also, this study aims to estimate costs between VAB and CNB with and without metal clip placement.

## METHODS

This study was approved by the Ethics Committee of A.C. Camargo Cancer Center, reference number 2,522/18. Due to the retrospective nature of the study, formal consent is not required. A retrospective cohort study encompassing women submitted to US-guided CNB breast lesions smaller than 2 cm with metal clip placement, between October 2016 and December 2017, extracted from the A.C. Camargo Cancer Center medical records.

US-guided CNB was performed using free-hand technique, guided by a 5-12 MHz linear-array transducer. After local anesthesia, a 14-gauge semi-automated needle was inserted by the radiologist through a small skin incision and advanced towards the target lesion using US guidance. Once needle location is confirmed, four or five core samples were obtained, as decided by each radiologist. Samples were immediately fixed in small formalin containers. A metallic clip was placed on the biopsy site at the end of the sampling and a post-biopsy mammogram was performed to confirm proper lesion targeting. Biopsies were performed by a team of radiologists, including medical residents supervised by radiologists with 5 to 25 years of experience in percutaneous biopsy.

Imaging findings of biopsied breast lesion and pathologic results of CNB were described in absolute and relative frequencies. Baseline patient characteristics were expressed as absolute and relative frequencies for qualitative variables and as the median, minimum, and maximum values for quantitative variables. Costs of CNB with and without metal clip placement and VAB were estimated through the average costs between the health insurances attended at A.C. Camargo. Data regarding costs were provided by financial department. Costs were compared by financial source and expressed as relative frequency.

False negative rates were calculated for lesions smaller than 10 mm or 10–20 mm. Upgrading rate was calculated when CNB resulted atypical or benign, but surgery diagnosed a malignant lesion. All statistical analyses were carried out with the Statistical Package for Social Science (SPSS) version 25 (IBM Corp., Armonk, NY, USA).

## RESULTS

Percutaneous US-guided CNB with metal clip placement was performed in 388 female patients between October 2016 and December

2017. Patients' mean age was 53.3 years-old (range, 20-94 years; mean  $\pm$  standard deviation [SD], 53.3  $\pm$  13.4). Ultrasound findings of biopsied lesions were masses (91.2%) and nonmass findings (8.8%) (Table 1). Mean size of biopsied lesions was 12.2 mm (range, 3-20 mm; mean  $\pm$  SD, 12.2  $\pm$  4.5). Pathologic results of US-guided CNB diagnosed invasive ductal carcinoma (49.7%), invasive lobular carcinoma (2.6%), ductal carcinoma *in situ* (4.6%), lesions of high-risk (3.4%), and benign findings (29.4%) (Table 2).

Some lesions were surgically excised, and the choice of surgery was made at the discretion or request of the physician or patient. Of the 388 patients included in this study, 317 patients (81.7%) underwent surgery after biopsy: 221 patients (69.7%) underwent conservative surgery and 96 patients (30.6%) underwent mastectomy. For adequate intraoperative localization, lesion or metal clip was pre-operatively marked by US-guided injection of technetium<sup>99</sup> (radio-guided occult lesion localization – ROLL) in 225 (86.9%) patients.

Table 3 summarizes histological findings of US-guided CNB and surgery for lesions smaller than 10 mm and between 10 to 20 mm, and for masses/lumps and nonmasses findings. Two cases of false-positive were identified. One case refers to a patient submitted to neoadjuvant chemotherapy who presented a complete

**Table 1.** Characteristics of US-guided core-needle biopsy breast lesions with metal clip placement.

Image findings of biopsied lesions	n (%)
Lumps/Masses	354 (91.2)
Nonmass Findings	34 (8.8)

US: ultrasound.

**Table 2.** Pathologic findings of breast ultrasound-guided core-needle biopsy with metal clip placement.

Pathologic Findings of biopsied lesions	n (%)
Breast Cancer	221 (56.9)
Invasive Ductal Carcinoma	193 (49.7)
Invasive Lobular Carcinoma	2.6)
Ductal Carcinoma <i>in situ</i>	18 (4.6)
High-risk	13 (3.4)
Atypical Ductal Hyperplasia	7 (1.8)
Atypical Lobular Hyperplasia	(0.8)
Lobular Carcinoma <i>in situ</i>	3 (0.8)
Benign	114 (29.4)
Fibroadenoma	47 (12.1)
Stromal Fibrosis of breast tissue	39 (10.1)
Pseudoangiomatous Stromal Hyperplasia (PASH)	3 (0.8)
Papillary Lesion	25 (6.4)
Others	40 (10.3)
Total	388 (100)

pathological response. Second case regards to the absence of residual tumor in surgery due to its removal on biopsy. According to the pathological report of this case, tumor comprised 90% of the biopsy material, which measured 1.7 cm.

Overall FNR for US-guided CNB with metal clip placement was 9.8%, higher for lesions smaller than 10 mm (16.2%) and lower for lesion ranging 10–20 mm (5.2%). When compared by radiologic findings, FNR was 0.9% for masses/lumps and 6.7% for nonmasses lesions (Table 4).

Overall sensibility overall was 90.2% (83.8% for lesions  $\leq$  10 mm; 94.8% for lesions 10–20 mm) and overall specificity was 94.9% (96% for lesions  $\leq$  10 mm; 94.1% for lesions 10–20 mm). US-guided CNB sensibility for masses/lumps was 99.1%, slightly higher than for nonmasses (93.3%) (Table 4).

Overall PPV and NPV were 98.7 and 69.1%. For lesion  $\leq$  10 mm, values were 98.8% and 60% and for lesions 10–20 mm, 98.6% and

80%, respectively. PPV and NPV for masses/lumps were 90.8% and 95.9%. Overall accuracy rate was 91.1% (86.3% for lesions  $\leq$  10 mm and 94.7% for lesions 10–20 mm). Accuracy for masses/lumps was 91.6%. Overall upgrading rate between pathological finding of CNB and surgery was 7.1%, being higher for lesions  $\leq$  10 mm (12.1%) than for lesions 10–20 mm (3.7%) (Table 4).

Comparison between costs of US-guided CNB with and without metal clip placement and VAB according to financial source (private *versus* healthcare insurance) is displayed in Table 5. Cost of VAB was 2.2 times higher than US-guided CNB when payment source is private (*i.e.*, paid by the patient) and 12.5 times higher when payment is provided by healthcare insurers. Introduction of a metal clip at the time of CNB entails a higher cost to the procedure, but, even so, VAB is more expensive and costs 1.95 times more than US-guided CNB when payment source is private and 5.2 times more when payment is by insurers (Table 5).

**Table 3.** Pathologic results of the US-guided core-needle biopsy biopsies *versus* pathological results of surgical specimen.

Size (mm)			Surgery			Total
			Benign	Malign	Atypical	
$\leq$ 10	Biopsy	Benign	24	11	5	40
		Malign	0	72	2	74
		Atypical	1	4	5	10
	Total		25	87	12	124
$>$ 10	Biopsy	Benign	32	5	3	40
		Malign	2	139	0	141
		Atypical	0	2	5	7
	Total		34	146	8	188
Total	Biopsy	Benign	56	16	8	80
		Malign	2	211	2	215
		Atypical	1	6	10	17
	Total		59	233	20	312
Radiologic Findings			Surgery			Total
			Benign	Malign	Atypical	
Nonmasses	Biopsy	Benign	9	2	1	12
		Malign	1	12	0	13
		Atypical	0	0	2	2
	Total		10	14	3	27
Masses/Lumps	Biopsy	Benign	47	15	7	69
		Malign	1	200	2	203
		Atypical	1	6	8	15
	Total		49	221	17	287
Total	Biopsy	Benign	56	17	8	81
		Malign	2	212	2	216
		Atypical	1	6	10	17
	Total		59	235	20	314

US: ultrasound.

## DISCUSSION

Advancements in imaging technology and increased access to screening programs allow for the detection of non-palpable breast lesions, which require a pathological examination if suspicious for malignancy. Two indicators of the reliability of a pathological diagnosis of a percutaneous biopsy are the repeat biopsy rate (RBR) and FNR<sup>4</sup>. RBR is the rate at which a repeat needle biopsy or a surgical biopsy is performed after a benign result<sup>4</sup>. RBR for VAB and CNB are reported to range from 5.7%–14% and 10.9%–17%, respectively, and vary with needle size<sup>4,9</sup>.

FNR of US-guided CNB may vary according to breast lesion size and CNB needle size. A Chinese study evaluated 955 breast lesions biopsied by US-guided CNB and concluded that US-guided CNB is better for breast lesions bigger than 10 mm, and, for lesions  $\leq 10$  mm, a larger core needle caliber or VAB may be necessary<sup>10</sup>. In this same study, FNR for breast lesions  $\leq 10$  mm was 4.3% and 0.7% when  $> 10$  mm<sup>10</sup>. As in the Chinese study, our data demonstrated that US-guided CNB is better for lesions higher than 10 mm. However, higher FNR reported in this study might be due to our smaller sample size, as well as we considered lesions between 10 and 20 mm.

Overall FNR for US-guided CNB are reported to range from 0% to 11.8%<sup>11</sup>. Overall FNR for US-guided VAB are reported to be 1%–5.2%<sup>4,12</sup>. Overall FNR of this study was 9.8%, in accordance to FNR reported in literature for US-guided CNB.

Sensitivity, specificity, and accuracy of CNB has been described for palpable (93.6%, 88.7%, and 90.8% respectively) and not palpable lesions (94.5%, 87.8%, and 90.5%)<sup>13</sup>. A Brazilian study evaluated 88 patients submitted to VAB and posterior excisional biopsy, where US-guided VAB sensitivity was of 84.2%, specificity of 100%, PPV of 100%, and NPV of 98%<sup>14</sup>. Comparing the results of our study, US-guided CNB with metal clip placement has a

higher sensibility than US-guided VAB and a higher specificity and accuracy than US-guided CNB. Also, our data showed a great PPV, slightly lower than reported to US-guided VAB. However, NPV of our study is much lower than reported from US-guided VAB, especially for lesions  $\leq 10$  mm. Hence, we suggest that a benign result of a US-guided CNB biopsy should be followed up by imaging exams in 6 months or surgically excised, in cases of radiologic-clinical disagreement.

Lesions at high-risk comprise 3%–9% of CNB results and include papillary lesions, radial scar, atypical ductal hyperplasia (ADH), atypical lobular hyperplasia (ALH), lobular carcinoma *in situ* (LCIS), and fibroepithelial tumors<sup>9</sup>. In our study, 3.4% of histological CNB findings are high-risk lesions, according to what is reported in the literature. Upgrading rate includes benign or atypical lesions in CNB that were diagnosed as malignant lesions after surgery. Upgrading rates for ADH in ductal carcinoma *in situ* (DCIS) or invasive carcinoma (ICD) are reported to be 12%–54%, and factors associated to upgrading rate are ipsilateral breast symptoms, use of 14G CNB in comparison of 11G CNB, severe ADH and co-diagnosis of papilloma<sup>15</sup>. Upgrading rates of VAB is reported to range from 10%–20%<sup>9,12</sup>. The overall upgrading rate found in this study (7.1%) is smaller than the reported in the literature, even lower when considered for lesions 10–20 mm (3.7%).

Main limitation of VAB is related to its costs. Alonso-Bartolomé et al.<sup>8</sup> analyzed the financial outlays of VAB and concluded that VAB systems are ten times more expensive than standard CNB, but 82% lower than surgical biopsies. In Japan, VAB costs around three times more than CNB<sup>4</sup>. In US, Grady et al.<sup>16</sup> showed that there is no difference between costs of US-guided CNB and non-tethered VAB devices, but when compared only tethered VAB devices and CNB, VAB is better cost-effective. To calculate costs of VAB and CNB, Grady et al.<sup>16</sup> included repeated biopsies

**Table 4.** False negative rate (FNR), sensibility, specificity, positive predictive value (PPV), negative predictive value (NPV), accuracy, and upgrading rate of US-guided core-needle biopsy.

Size (mm)	FNR (%)	Sensibility (%)	Specificity (%)	PPV (%)	NPV (%)	Accuracy (%)	Upgrading (%)
$\leq 10$	16.2	83.8	96	98.8	60	86.3	12.1
10–20	5.2	94.8	94.1	98.6	80	94.7	3.7
Nonmasses	6.7	93.3	75	82.4	90	85.2	7.4
Masses/Lumps	0.9	99.1	68.1	90.8	95.9	91.6	7.3
All	9.8	90.2	94.9	98.7	69.1	91.1	7.1

US: ultrasound.

**Table 5.** Comparison between US-guided core-needle biopsy (CNB) and vacuum assisted biopsy (VAB) according to financial source (private *versus* healthcare insurance), with or without metal clip placement.

Method of breast biopsy	Private	Insurance	Private + Metal Clip	Insurance + Metal Clip
US-guided CNB	X	Y	Z	W
VAB	2.2 X	12.5 Y	1.95 Z	5.2 W

US: ultrasound.

and surgical biopsies when needed. Unfortunately, Brazilian public health system and some health insurers do not provide access to VAB because of its costs. Our study is the first Brazilian study to estimate costs of CNB and VAB considering the financial source where VAB is available. In our study, VAB costs 2.2 times US-guided CNB for private payment and 12.5 times when the payment is made by the healthcare insurer. However, placement of metal clip enhances CNB costs VAB still costs 1.95 times CNB (private) and 5.2 times (insurance).

Some limitations of this study are related to a retrospective study, such as missing data and the absence of a VAB arm for comparison to US-guided CNB and US-guided VAB arms. Herein, biopsies were performed by a team of radiologists with different years of experience in percutaneous biopsy. Also, a cost-effective study was not performed, and the costs were estimated according to financial reports.

Nevertheless, this study was able to demonstrate that, for lesions bigger than 10 mm, US-guided CNB with metal clip placement has high sensitivity, specificity, accuracy, and PPV and low FNR. So, our results suggest that US-guided CNB is an accurate approach to lesions that can be seen on US, besides being cost-effective.

## CONCLUSIONS

US-guided CNB showed a low FNR, especially when done in lesions larger than 10 mm. Also, US-guided CNB with metal clip placement has high sensitivity, specificity, accuracy, and PPV, even for lesions under 10 mm. Moreover, US-guided CNB with metal clip placement is less expensive than VAB, regardless of the source of payment. In conclusion, US-guided CNB is an accurate approach to lesions that can be seen on US, besides being cost-effective.

## AUTHORS' CONTRIBUTIONS

R.E.M., M.P.C., E.C.R.S.F., T.A.: data collection, investigation.

M.S.: data analysis, writing – original draft, writing – review and editing.

C.S.G., L.G., J.S.: performed core biopsies.

R.C.N. and S.S.S.: study design.

V.F.C.: statistical analysis.

A.G.V.B.: study design, performed core biopsies, data analysis, writing – review.

F.B.A.M.: project administration, study design, data analysis, writing – review.

## REFERENCES

- Lee BL, Liedke PER, Barrios CH, Simon SD, Finkelstein DM, Goss PE. Breast cancer in Brazil: Present status and future goals. *Lancet Oncol.* 2012;13(3):e95-102. [http://dx.doi.org/10.1016/S1470-2045\(11\)70323-0](http://dx.doi.org/10.1016/S1470-2045(11)70323-0)
- Makdissi FB, Leite FPM, Peres SV, Silva DRM e, Oliveira MM de, Lopez RVM, et al. Breast cancer survival in a Brazilian cancer center: a cohort study of 5,095 patients. *Mastology.* 2019;29(1):37-46. <https://doi.org/10.29289/2594539420190000437>
- Bennett IC, Saboo A. The Evolving Role of Vacuum Assisted Biopsy of the Breast: A Progression from Fine-Needle Aspiration Biopsy. *World J Surg.* 2019;43:1054-61. <https://doi.org/10.1007/s00268-018-04892-x>
- Nakano S, Imawari Y, Mibu A, Otsuka MH, Oinuma T. Differentiating vacuum-assisted breast biopsy from core needle biopsy: Is it necessary? *Br J Radiol.* 2018;91(1092):20180250. <https://dx.doi.org/10.1259%2Fbjr.20180250>
- Schulz-Wendtland R, Dankerl P, Bani MR, Fasching PA, Heusinger K, Lux MP, et al. Evaluation of a marker clip system in sonographically guided core needle biopsy for breast cancer localization before and after neoadjuvant chemotherapy. *Geburtshilfe Frauenheilkd.* 2017;77(2):169-75. <https://dx.doi.org/10.1055%2Fs-0042-124191>
- Andrade WP, Brites MR, Marques EF, Maciel M do S, Alves MGCP. Modelo alternativo para introdução de clipe cirúrgico para localização do leito tumoral em pacientes submetidos à quimioterapia neoadjuvante: descrição da técnica. *Rev Bras Mastol.* 2012;22(2):46-50.
- Nigenda G, Gonzalez-Robledo MC, Gonzalez-Robledo LM, Bejarano-Arias RM. Breast cancer policy in Latin America: Account of achievements and challenges in five countries. *Global Health.* 2016;12:39. <https://dx.doi.org/10.1186%2Fs12992-016-0177-5>
- Alonso-Bartolomé P, Vega-Bolívar A, Torres-Tabanera M, Ortega E, Acebal-Blanco M, Garuo-Ayensa F, et al. Sonographically guided 11-G directional vacuum-assisted breast biopsy as an alternative to surgical excision: Utility and cost study in probably benign lesions. *Acta Radiol.* 2004;45(4):390-6. <https://doi.org/10.1080/02841850410005633>
- Londero V, Zuiani C, Linda A, Battigelli L, Brondani G, Bazzocchi M. Borderline breast lesions: Comparison of malignancy underestimation rates with 14-gauge core needle biopsy versus 11-gauge vacuum-assisted device. *Eur Radiol.* 2011;21(6):1200-6. <https://doi.org/10.1007/s00330-010-2053-7>
- Zhou JY, Tang J, Wang ZL, Lv FQ, Luo YK, Qin HZ, et al. Accuracy of 16/18G core needle biopsy for ultrasound-visible breast lesions. *World J Surg Oncol.* 2014;12:7. <https://dx.doi.org/10.1186%2F1477-7819-12-7>
- Povoski SP, Jimenez RE, Wang WP. Ultrasound-guided diagnostic breast biopsy methodology: Retrospective comparison of the 8-gauge vacuum-assisted biopsy approach versus the spring-loaded 14-gauge core biopsy approach. *World J Surg Oncol.* 2011;9:87. <https://doi.org/10.1186/1477-7819-9-87>
- O'Flynn EAM, Wilson ARM, Michell MJ. Image-guided breast biopsy: state-of-the-art. *Clin Radiol.* 2010;65(4):259-70. <https://doi.org/10.1016/j.crad.2010.01.008>

13. Ciatto S, Houssami N, Ambrogetti D, Bianchi S, Bonardi R, Brancato B, et al. Accuracy and underestimation of malignancy of breast core needle biopsy: The Florence experience of over 4000 consecutive biopsies. *Breast Cancer Res Treat.* 2007;101(3):291-7. <https://doi.org/10.1007/s10549-006-9289-6>
14. Ambrosio ACC, Kemp C, Gonçalves TD, Lima GR de. Valor da mamotomia no diagnóstico e na terapia de lesões não palpáveis. *Rev Bras Ginecol Obs.* 2004;26(1):37-42 <https://doi.org/10.1590/S0100-72032004000100006>
15. Deshaies I, Provencher L, Jacob S, Côté G, Robert J, Desbiens C, et al. Factors associated with upgrading to malignancy at surgery of atypical ductal hyperplasia diagnosed on core biopsy. *Breast.* 2011;20(1):50-5. <https://doi.org/10.1016/j.breast.2010.06.004>
16. Grady I, Vasquez T, Tawfik S, Grady S. Ultrasound-Guided Core-Needle Versus Vacuum-Assisted Breast Biopsy: A Cost Analysis Based on the American Society of Breast Surgeons' Mastery of Breast Surgery Registry. *Ann Surg Oncol.* 2017;24(3):676-82. <https://doi.org/10.1245/s10434-016-5607-3>



# Nutritional status and cardiovascular risk in women with breast cancer

Thayanne Breckenfeld Meneses<sup>1\*</sup> , Tamires Regina da Silva Cunha<sup>1</sup> , Maria Goretti Pessoa de Araújo Burgos<sup>1</sup> 

## ABSTRACT

**Objective:** To evaluate the nutritional status and the cardiovascular risk in women with breast cancer and identify factors associated with excessive body weight. **Methods:** A descriptive, cross-sectional, quantitative study was carried out in an oncology outpatient clinic and, gynecology/oncology wards at the Hospital das Clínicas da Universidade Federal de Pernambuco, from March to August 2019. The data analyzed was related to sociodemographic, gynecologic, clinic, anthropometric and lifestyle factors. Nutritional status was assessed using Body Mass Index, considering excessive body weight when  $> 25 \text{ kg/m}^2$  for adults and  $> 27 \text{ kg/m}^2$  for elderly. Obesity was considered  $> 30 \text{ kg/m}^2$ . Cardiovascular risk was defined by waist circumference ( $\geq 80 \text{ cm}$ ), neck circumference ( $\geq 34 \text{ cm}$ ) and waist-to-height ratio ( $> 0.5$ ). **Results:** A total of 46 patients were included, with a mean age of 51.9 years, and the majority in outpatient follow-up. The population was mostly Caucasian women, who were married or in a civil union, who had had at least one pregnancy, were in menopause, and were sedentary. High frequencies of excessive body weight (76.1%) and obesity (43.5%) were observed, and anthropometric parameters revealed an elevated frequency of cardiovascular risk in this population, waist circumference (97.8%), neck circumference (84.8%), and waist-to-height ratio (95.7%). Unemployment ( $p = 0.020$ ), and waist ( $p = 0.001$ ) and neck ( $p = 0.001$ ) circumferences were statistically associated factors to excessive body weight. **Conclusions:** The anthropometric profile of women with breast cancer indicated excess body weight and elevated cardiovascular risk, which suggests to the need for nutrition intervention and follow-up after the diagnosis.

**KEYWORDS:** breast neoplasms; nutritional status; obesity; lifestyle; cardiovascular diseases.

## INTRODUCTION

Breast cancer originates from the uncontrolled and disordered growth of abnormal cells. There is a high incidence among females, with estimates that exceed two million new cases diagnosed in 2018 worldwide, and 66,280 new cases for the year 2020, in Brazil. Not considering non-melanoma skin tumors, breast cancer is the most common type of cancer in the Northeast Region of Brazil. It is estimated that, for every 100 thousand women, 47.86 new cases have been diagnosed in the state of Pernambuco in 2020. In Recife, this incidence rises to 61.44 new cases per 100 thousand women. It is also the major cause of cancer mortality in this population<sup>1,2</sup>.

A large proportion of cancer cases in the world are related to exposure to environmental and behavioral risk factors throughout life. In the case of breast cancer, there are several factors related to increased risk, such as: reproductive factors (early menarche, nulliparity, menopause after 55 years, age at first pregnancy over 30 years old), alcoholism, physical inactivity, excess body weight, among others<sup>3,4</sup>.

With the growing global obesity epidemic, an increase in the number of cancer cases related to excess weight has been observed concomitantly. In Brazil, 3.8% of cancer cases diagnosed in 2012 were related to a high body mass index (BMI), with a higher incidence in women (5.2%). Furthermore, breast cancer was most related to being overweight<sup>5</sup>.

World-class evidence indicates that both high BMI throughout life and weight gain during menopause are risk factors for the development of post-menopausal breast cancer<sup>6</sup>. Excess weight has been associated not only with the development of the disease, but also with a worse prognosis, higher mortality, recurrences, larger tumors and clinical complications such as lymphedema, peripheral neuropathies, chemotherapy-related cardiotoxicity, chronic fatigue and worsening quality of life. After diagnosis, about half of this population tends to gain weight, especially those undergoing chemotherapy<sup>7</sup>.

Cardiovascular disease (CVD) is an important cause of morbidity and mortality in breast cancer, and its development may

<sup>1</sup>Universidade Federal de Pernambuco – Recife (PE), Brazil.

\*Corresponding author: thayanne.breckenfeld@gmail.com

Conflict of interests: nothing to declare.

Received on: 05/06/2020. Accepted on: 06/29/2019.

be related or aggravated by antineoplastic treatment<sup>8</sup>. In the nutritional assessment, some anthropometric parameters can show the increased risk of developing CVD. Waist circumference (WC) is a measure used to identify this risk, as it reflects the individual's body composition, mainly showing visceral fat<sup>9</sup>. The 2016 Brazilian Obesity Guidelines portray the superiority of the WC compared to hip circumference and waist-to-hip ratio. However, they say that the waist-height ratio (WHR) is the best parameter when compared to WC and BMI, as it is a predictor of increased mortality<sup>10</sup>. Another recommended measure is neck circumference (NC), which is associated with adiposity, central obesity and other cardiovascular risk factors, such as arterial hypertension, dyslipidemia and insulin resistance<sup>11,12</sup>.

Considering this, the objective of this study was to assess the nutritional status and cardiovascular risk in women with breast cancer, identifying factors associated with being overweight.

## METHODS

This was a cross-sectional analytical observational study of a quantitative nature, which involved women with breast cancer, and was carried out from March to August 2019. It was carried out in the oncology and gynecology wards and the oncology outpatient clinic of the Hospital das Clínicas of the Universidade Federal de Pernambuco (HC/UFPE). The research was carried out in accordance with resolutions 466/2012 and 510/2016, of the National Health Council, having been approved by the Research Ethics Committee Involving Human Beings of HC/UFPE, under Certificate of Presentation for Ethical Appreciation (*Certificado de Apresentação para Apreciação Ética* - CAAE) number 06498919.4.0000.8807.

The sample was non-probabilistic, selected for convenience, and included women with a diagnosis of breast cancer established by histopathological examination, aged  $\geq 19$  years old. Those who were unable to answer the survey questionnaire and/or who had physical restrictions limiting the collection of anthropometric data were excluded.

The studied variables were comprised of sociodemographic data, such as age group, skin color (self-reported), marital status, education, origin, occupation, family income, number of people per household and access to basic sanitation; gynecological variables, such as age at menarche, history of breastfeeding, duration of breastfeeding, use of oral contraceptives and menopause; obstetric variables, such as number of pregnancies, parity, number of miscarriages, age at first pregnancy.

Nutritional status was assessed using BMI, while cardio-metabolic risk was identified using WC, NC and waist-height ratio. To measure weight, an electronic scale with a capacity of 150 kg was used. For height, a stadiometer coupled to the scale was used to aid measurement. BMI was classified according to

the World Health Organization (WHO) cutoff points<sup>9</sup> for adults, and according to Lipschitz<sup>13</sup> for elderly patients ( $> 60$  years).

WC and NC were measured with the aid of a non-extensible measuring tape. The first was measured at the midpoint between the iliac crest and the outer face of the last rib. The second was measured with the tape measure positioned at the midpoint of the cervical spine to the middle-anterior part of the neck. For classification of WC, the values recommended by the WHO<sup>9</sup> were adopted. Those considered high risk were those with WC  $\geq 80$  cm, and very high risk were those with WC  $\geq 88$  cm. In the NC classification, the value  $\geq 34$  cm was considered as metabolic risk<sup>14</sup>. The WHR was obtained by dividing the waist (cm) by height (cm), and the values were at risk when above 0.5<sup>10</sup>.

Clinical variables were collected from medical records. The time of diagnosis, age at diagnosis, presence of metastasis, treatment and relapse were investigated. As for lifestyle, the practice of physical activity, smoking and alcohol use were evaluated. In assessing the practice of physical activity, women who practiced physical exercise for at least 30 min/day five to seven days a week on a continuous or accumulated basis, were considered active and those considered inactive did not regularly practice physical activity<sup>15</sup>. Regarding alcohol consumption, women who drank alcoholic beverages above a dose (14g of ethanol) per day<sup>15</sup> were classified as alcoholics. Smokers were those who consumed one or more cigarettes a day<sup>16</sup>.

The data were analyzed descriptively by means of absolute and percentage frequencies for categorical variables, and average, standard deviation and median for numerical variables. To assess the difference between the percentages relative to the categories of a variable, Pearson's  $\chi^2$  test was used for equality of proportions in a sample. In the numerical variables, the confidence intervals for the average were obtained and, to assess the association between two categorical variables, Pearson's  $\chi^2$  test or Fisher's Exact test was used when the condition for using the  $\chi^2$  test was not verified. The margin of error used in deciding the statistical tests was 5% and the intervals were obtained with 95% confidence. The data were entered into an Excel spreadsheet and the program used to obtain the statistical calculations was the Statistical Package for the Social Sciences (SPSS), version 23.

## RESULTS

The sample consisted of 46 patients, 73.9% from the oncology outpatient clinic and the others were hospitalized. The mean age was  $51.9 \pm 10.91$  years, with the adult age group prevailing. The other sociodemographic characteristics are described in Table 1.

Tables 2 and 3 show the gynecological and obstetric data of the population, in which the most common were: menarche was above 12 years old, no pregnancies older than 30 years old, parity  $\geq 2$ , breastfeeding and currently menopausal.

Regarding anthropometric data (Table 4), the average BMI was  $29.12 \pm 5.53 \text{ kg/m}^2$ , showing excess weight, while obesity, with a BMI  $\geq 30 \text{ kg/m}^2$ , was present in 43.5% of women. Regarding WC, the average was 99.16 cm ( $\pm 11.94$ ), while 97.8% had measurements  $\geq 80$  cm, of which 84.4% had WC  $\geq 88$  cm, indicating a high frequency of abdominal obesity, with very high cardiovascular risk. The NC showed an average of  $37.14 \pm 3.14$  cm, with a predominant metabolic risk classification. Table 5 shows the association between BMI and sociodemographic, gynecological and

**Table 1.** Sociodemographic characteristics of breast cancer patients. Hospital das Clínicas, Universidade Federal de Pernambuco. Recife, PE, Brazil, 2019.

Variable	n	%	p
Age group			
Elderly	15	32.6	p* = 0.018 **
Adults	31	67.4	
Race			
Caucasians	24	52.2	p* = 0.768
Non- Caucasians	22	47.8	
Marital status			
Married/Common-law married	25	54.3	p* = 0.555
Single/Divorced/Widowed	21	45.7	
Education level			
<9 years	21	45.7	p* = 0.555
$\geq 9$ years	25	54.3	
Place of birth			
Inhabitant of the Metropolitan Region of Recife	25	54.3	p* = 0.555
Inhabitant of other regions	21	45.7	
Occupation			
Part of the labor market	14	30.4	p* = 0.008**
Unemployed	32	69.6	
Family income (MW)			
Less than 1	5	10.9	p* < 0.001**
1 to 2	31	67.4	
More than 2	10	21.7	
People per household			
Up to 2	19	41.3	p* = 0.238
3 or more	27	58.7	
Basic sanitation			
Yes	37	80.4	p* < 0.001**
No	9	19.6	

\*Significant difference at 5%; \*\*using the  $\chi^2$  test to compare proportions in a sample; MW: minimum wage of R \$998.00 (2019.1).

**Table 2.** Gynecological characteristics of breast cancer patients. Hospital das Clínicas, Universidade Federal de Pernambuco. Recife, PE, Brazil, 2019.

Variable	n	%	p
Age at menarche			
Up to 12 years old	16	34.8	p* < 0.001**
Older than 12 years old	30	65.2	
Breastfeeding history			
Yes	33	71.7	p* = 0.003**
No	13	28.3	
Breastfeeding time (months)			
< 6	11	23.9	p* = 0.913
6 to 12	12	26.1	
> 12	10	21.7	
Not applicable (did not breastfeed/was not pregnant)	13	28.3	
Use of oral contraceptives			
Yes	24	52.2	p* = 0.768
No	22	47.8	
Menopause			
Yes	35	76.1	p* < 0.001**
No	11	23.9	

\*Significant difference at 5%; \*\*using the  $\chi^2$  test to compare proportions in a sample.

**Table 3.** Obstetric characteristics of breast cancer patients. Hospital das Clínicas, Universidade Federal de Pernambuco. Recife, PE, Brazil, 2019.

Variable	n	%	p
Number of pregnancies			
0	3	6.5	p* = 0.043**
1	7	15.2	
2	14	30.4	
3	14	30.4	
4 or more	8	17.4	
Parity			
0	4	8.7	p* = 0.035**
1	10	21.7	
2	16	34.8	
3 or more	16	34.8	
Miscarriages			
0	32	69.6	p* = 0.008**
1 or more	14	30.4	
Age at first pregnancy			
12 to 19	13	28.3	p* = 0.850
20 to 24	16	34.8	
25 to 29	14	30.4	
No pregnancies	3	6.5	

\*Significant difference at 5%; \*\* using the  $\chi^2$  test to compare proportions in a sample.



**Table 4.** Anthropometric characteristics of breast cancer patients. Hospital das Clínicas of the Universidade Federal de Pernambuco. Recife, PE, Brazil, 2019.

Variable	n	%	p
<b>BMI</b>			
Malnourished	3	6.5	p* < 0.001**
Eutrophic	8	17.4	
Overweight	35	76.1	
<b>WC</b>			
No risk (<80 cm)	1	2.2	p* < 0.001**
High risk (≥ 80 cm)	7	15.2	
Very high risk (≥ 88 cm)	38	82.6	
<b>NC</b>			
No risk	7	15.2	p* < 0.001**
Metabolic risk (≥ 34 cm)	39	84.8	
<b>WHR</b>			
No risk	2	4.3	p* < 0.001**
Metabolic risk (> 0.5)	44	95.7	

\*Significant difference at 5%; \*\* using the  $\chi^2$  test to compare proportions in a sample; BMI: body mass index; WC: waist circumference; NC: neck circumference; WHR: waist-to-height ratio.

anthropometric variables. Significant associations were found with WC, NC and unemployment.

With regard to clinical variables, 73.9% reported a family history of cancer, 71.8% had a diagnosis time  $\leq$  one year, while 26.1% were identified with distant metastasis. As for treatment, 60.9% had undergone breast surgery, 84.8% were undergoing chemotherapy, 26.1% had undergone radiotherapy and 17.4% had undergone hormone therapy. More than half of the group did not have other comorbidities associated with cancer, however, 21.7% were hypertensive, 6.5% were diabetic and 8.7% had these associated pathologies. Regarding lifestyle, 80.4% were sedentary and the majority (97.8%) were non-drinkers and non-smokers.

## DISCUSSION

The results of this study corroborate the profile of breast cancer patients described in the literature, of women predominantly in the age group of 50 years old, married/in a civil union, who had at least one pregnancy, were in menopause, with a family history of cancer, and had a low adherence to physical activity.

**Table 5.** Association between body mass index (BMI) and sociodemographic, gynecological and anthropometric variables in patients with breast cancer. Hospital das Clínicas, Universidade Federal de Pernambuco. Recife, PE, Brazil, 2019.

Variable	Total		BMI				p-value*
	n	%	Malnourished and Eutrophic		Overweight		
			n	%	n	%	
<b>Age group</b>							
Elderly	15	32.6	6	54.5	9	25.7	p* = 0.137
Adults	31	67.4	5	45.5	26	74.3	
<b>Race</b>							
Caucasian	24	52.2	6	54.5	18	51.4	p** = 0.857
Non-Caucasian	22	47.8	5	45.5	17	48.6	
<b>Age of menarche</b>							
Less than 12 years old	16	34.8	3	27.3	13	37.1	p* = 0.722
≥ 12 years old	30	65.2	8	72.7	22	62.9	
<b>Use of OAC</b>							
Yes	24	52.2	3	27.3	21	60.0	p* = 0.058
No	22	47.8	8	72.7	14	40.0	
<b>Occupation</b>							
Part of the labor market	14	30.4	-	-	14	40.0	p* = 0.020 ***
Unemployed	32	69.6	11	100.0	21	60.0	
<b>Education level</b>							
< 9 years	21	45.7	5	45.5	16	45.7	p** = 0.988
≥ 9 years	25	54.3	6	54.5	19	54.3	
<b>WC</b>							
High (≥ 80 cm)	7	15.5	7	70	-	-	p* < 0.001***
Very high (≥ 88 cm)	38	84.5	3	30	35	100	
<b>CP</b>							
No risk (<34 cm)	7	15.2	7	89.7	-	-	p* < 0.001***
Risk (≥ 34 cm)	39	84.8	4	10.3	35	100	

\*Fisher's exact test; \*\*using Pearson's  $\chi^2$  test; \*\*\*significant difference at 5%; OAC: oral contraceptive; WC: waist circumference; NC: neck circumference.

The data are similar to those of other studies because they are derived from populations served by the Public Health System (*Sistema Único de Saúde* – SUS), even though they represent different regions of Brazil. However, a similar profile can also be found in international surveys<sup>4,6,17–20</sup>.

As for the sanitary housing location, only 19.6% did not have access to adequate basic sanitation, an aspect that has been little explored in surveys involving this public. However, Queiroz et al.<sup>18</sup>, in Rio Grande do Norte, identified that almost half of their sample had poor basic sanitation, which stood out as one of the risk factors associated with breast cancer. This factor may also be associated with the most vulnerable social class and low education levels, which converge to make accessing health services difficult, especially in the northeast of Brazil.

Cabral et al.<sup>21</sup> identified five profiles of patients with breast cancer, showing that women of greater social vulnerability were non-Caucasians, who had <8 years of schooling, and were SUS users. At the same time, they showed a social profile of Caucasian SUS users with 11 years of schooling, which would be a profile that is compatible with the present study, since more than half of this research sample had  $\geq 9$  years of schooling and was Caucasian. Nevertheless, in the study by Cabral et al., he observed that 39.6% of his sample had more advanced stages (III or IV) at the time of diagnosis, and the interval between diagnosis and the start of treatment exceeded 60 days in 45.8% of cases. Therefore, the evidence indicates that social characteristics and inequalities in access to health services have a relevant impact on early detection and treatment of breast cancer.

At the national level, the José Alencar Gomes da Silva National Cancer Institute (INCA)<sup>22</sup> points out that less than 10% of women diagnosed with breast cancer have the stage *in situ*, the initial stage of the disease, however, in the Northeast Region, the proportion of advanced cases represents about 40% of diagnoses. Such data are relevant when it is observed that 26.1% of the participants in the present study had metastasis in the diagnosis, which suggests a delay in the early identification of the disease.

The pathogenesis of breast cancer involves tissue response to environmental as well as hormonal stimuli. Risk factors are related to gynecological and reproductive history, such as early menarche (<12 years), nulliparity, age at first pregnancy (> 30 years) and use of oral contraceptives (OAC). Researching the clinical-epidemiological profile and related risk factors in the state of Ceará, Souza et al.<sup>20</sup> observed a predominance (greater than 70%) of women with early menarche, use of OAC and age at first pregnancy <25 years. Regarding this last factor, Sofi et al.<sup>4</sup>, in India, found compatible results. Similar data were detected in this study only in relation to the age of the first pregnancy and the use of OAC. On the other hand, there were different results regarding young age at menarche, since only one third of the population studied had it at  $\leq 12$  years old. Such factors increase the risk of developing breast cancer by increasing exposure to estrogen and progesterone hormones throughout life<sup>1,23</sup>.

Alcoholism and smoking are important behavioral factors related to this pathology. Souza et al.<sup>20</sup> reported that more than half of the group was formed by alcohol users and a third were smokers, data that differ from those found in this study, in which 97.8% reported being non-drinkers and non-smokers. Macacu et al.<sup>24</sup>, in their meta-analysis, showed that active, as well as passive, exposure to tobacco is a moderate risk factor for the development of breast cancer. By the same token, alcohol consumption is related to endogenous hormonal changes, increased oxidative stress and changes in metabolic pathways, in addition to producing a known carcinogenic compound, acetaldehyde, through the metabolism of ethanol. In large quantities, alcohol can predispose women to folate deficiency, among other nutrients, making the breast more susceptible to carcinogenesis. In addition, alcohol facilitates the cellular penetration of environmental carcinogens, for example, what is present in tobacco<sup>1</sup>.

As for breastfeeding, the Indian study<sup>4</sup> stands out. A total of 90% of the group performed breastfeeding for around 12 months. In Ceará<sup>20</sup>, the number was 74%. These values agree with our findings, which may be related to public breastfeeding policies in Brazil in recent years<sup>4</sup>. The INCA points out that there is a reduction in the risk of breast cancer due to hormonal mechanisms and tissue exfoliation, in addition to the apoptosis of breast cells in the breastfeeding process<sup>1</sup>.

Sofi et al.<sup>4</sup> report that miscarriages suffered throughout life have a positive association with breast cancer, a factor that is rarely present in the study population, in which only one third of women had one or more miscarriages. One of the changes that occur in women's bodies during full term pregnancy is the differentiation of epithelial cells from breast tissue, which is the factor responsible for reducing the risk of breast cancer. As such, miscarriage is equivalent to an interruption of the differentiation process, increasing the risk of cellular changes that could culminate in breast cancer<sup>25</sup>. However, despite the evidence cited, there is still controversy in the literature, and there is no consensus that miscarriage is a risk factor<sup>23</sup>.

In the analysis of the incidence of being overweight, which was determined based on BMI, there is a consensus in the literature that the frequency of this factor is extremely high. This was observed by Brazilian authors<sup>17–19,26</sup> who detected excess weight in the range of 53.4–85.5% of women and by international studies<sup>6,27</sup>, which has data similar to that found in this study.

Similarly, Mota et al.<sup>19</sup>, in the state of Goiás, showed 85.5% of excess weight by BMI in the studied sample. However, when assessing body composition using dual X-ray densitometry (DEXA), they observed that 100% of the group were overweight and had adiposity. Thus, they confirmed that BMI, in isolation, is not a good parameter for the nutritional assessment of this population. In this regard, it is worth highlighting the review published by Sheng et al.<sup>7</sup>, with suggestions for practical interventions for weight loss, such as awareness about the impact of obesity and the implications of chemotherapy and hormone treatments in relation to weight gain.

With regard to cardiovascular risk, it was observed that 84.5% of women had a very high risk, identified by WC  $\geq$  88 cm, which corroborates most breast cancer studies<sup>18,19,26</sup>. These findings show the need for health care in preventing the development of morbidities related to excess weight, especially in those patients who have a greater deposition for abdominal fat.

NC is an anthropometric parameter that has been associated with increased blood glucose, total cholesterol and fractions, and is therefore a good predictor for identifying cardiometabolic risk factors. This measure is considered to be an efficient marker for insulin resistance and cardiovascular risk in the general population, however, there are still few studies that address this measure in women affected by breast cancer<sup>12</sup>. Santos et al.<sup>28</sup> found a prevalence of 90% in women with NC  $\geq$  34 cm. These data agree with those of the present study, which identified a high cardiometabolic risk for NC. A total of 84.8% of patients presented NC  $\geq$  34 cm and demonstrated a risk for the development of diabetes *mellitus* and dyslipidemias, among other pathologies. Cardiometabolic risk was significant, with NC  $\geq$  34.88 cm. In comparison to healthy women, breast cancer patients had an android obesity profile with a higher concentration of body fat in the upper body, a profile associated with higher cardiovascular risk<sup>29</sup>.

As for the factors associated with excess weight, there was a statistical association with the anthropometric data of WC and NC, showing that women with excess weight have, concomitantly, a higher cardiovascular risk. In addition, unemployment had a statistically significant relationship, which may indicate the social vulnerability in which they are inserted. This factor influences access to healthy foods, mainly due to price and local availability, leading to a higher consumption of unhealthy foods with high energy density, which can cause predisposition to the development of excess weight, in addition to metabolic disorders<sup>30</sup>.

A study by Custódio et al.<sup>26</sup>, in Minas Gerais, found a relationship between low diet quality and nutritional status, showing that women with the worst scores were obese and had a higher cardiometabolic risk, assessed by WC, WHR, and waist-hip ratio. The authors also identified a reduction in the quality of the diet after chemotherapy, with consequently inadequate

anthropometric parameters. Ribeiro-Sousa et al.<sup>31</sup> identified a reduction in the level of physical activity and an increase in food consumption in women who progressed with weight gain during neoplastic treatment. Such evidence points to the importance of lifestyle factors in being overweight.

The aforementioned study finds high WHR in most of the evaluated patients, which is in agreement with the results of the present study, in which 95.7% presented metabolic risk based on the WHR. According to the Brazilian Association for the Study of Obesity and Metabolic Syndrome (*Associação Brasileira para o Estudo da Obesidade e da Síndrome Metabólica - ABESO*)<sup>10</sup>, the metabolic risk assessment is shown to be higher than the BMI and WC, demonstrating a relationship with the increase in mortality in the general population. Nutritional monitoring at the time of diagnosis, in addition to actions that promote a healthy lifestyle, are necessary interventions throughout the treatment of this public. Further studies are fundamental in order to confirm this data in populations with a greater number of women treated in outpatient or hospital settings.

A limitation of the present study was the reduced number of patients, in addition to the absence of biochemical tests such as lipid profile, which is related to increased cardiovascular risk.

## CONCLUSION

The women with breast cancer studied had a high risk of cardiovascular disease, which was indicated by the anthropometric profile. WC, NC and lack of participation in the job market were factors associated with being overweight.

## AUTHORS' CONTRIBUTIONS

M.G.P.B.: Design, methodology, investigation, project administration, supervision, visualization, writing — original draft, reviewing & editing.

T.R.S.C.: Methodology, data analysis, investigation, writing — reviewing & editing.

T.B.M.: Design, investigation, methodology, data collection, data analysis, writing — original draft, reviewing & editing.

## REFERENCES

1. Instituto Nacional de Câncer José Alencar Gomes da Silva. Prevenção e Fatores de risco para o câncer de mama [Internet]. 2019 [accessed on May 6, 2020. Available from: <https://www.inca.gov.br/tipos-de-cancer/cancer-de-mama/profissional-de-saude>
2. Instituto Nacional de Câncer José Alencar Gomes da Silva. Estimativa 2020: incidência de câncer no Brasil. Brasil: Instituto Nacional de Câncer José Alencar Gomes da Silva; 2019.
3. American Society of Cancer; Merck. Global burden of cancer in women: current status, trends, and interventions [Internet]. World Cancer Congress. Paris; 2016 [accessed on Dec 8, 2018]. Available from: <https://www.cancer.org/content/dam/cancer-org/research/cancer-facts-and-statistics/global-cancer-facts-and-figures/global-burden-of-cancer-in-women.pdf>

4. Sofi NY, Jain M, Kapil U, Seenu V, Lakshmy R, Yadav CP, et al. Reproductive factors, nutritional status and serum 25(OH) D levels in women with breast cancer: A case control study. *J Steroid Biochem Mol Biol*. 2018;175:200-4. <https://doi.org/10.1016/j.jsbmb.2017.11.003>
5. Rezende LFM, Arnold M, Rabacow FM, Levy RB, Claro RM, Giovannucci E, et al. The increasing burden of cancer attributable to high body mass index in Brazil. *Cancer Epidemiol*. 2018;54:63-70. <https://doi.org/10.1016/j.canep.2018.03.006>
6. Sun L, Zhu Y, Qian Q, Tang L. Body mass index and prognosis of breast cancer: an analysis by menstruation status when breast cancer diagnosis. *Medicine*. 2018;97(26):e11220. <https://doi.org/10.1097/md.00000000000011220>
7. Sheng JY, Sharma D, Jerome G, Santa-Maria CA. Obese Breast Cancer Patients and Survivors: Management Considerations. *Oncology (Williston Park)* [Internet]. 2018 [accessed on Nov 7, 2019]. Available from: <https://www.cancernetwork.com/breast-cancer/obese-breast-cancer-patients-and-survivors-management-considerations>
8. Sharma AV, Reddin G, Forrestal B, Barac A. Cardiovascular Disease Risk in Survivors of Breast Cancer. *Curr Treat Options Cardiovasc Med*. 2019;21. <https://doi.org/10.1007/s11936-019-0788-2>
9. World Health Organization. Obesity: preventing and managing the global epidemic. WHO Technical Report Series. Geneva: World Health Organization; 1999.
10. Associação Brasileira para o Estudo da Obesidade e da Síndrome Metabólica (ABESO). VI Diretrizes Brasileiras Obesidade. Brasil: ABESO; 2016.
11. Dai Y, Wan X, Li X, Jin E, Li X. Neck circumference and future cardiovascular events in a high-risk population - A prospective cohort study. *Lipids Health Dis*. 2016;15:46. <http://dx.doi.org/10.1186/s12944-016-0218-3>
12. Saad MAN, Rosa MLG, Lima GB, Antunes da Cruz Filho R. A circunferência do pescoço prediz a resistência insulínica no idoso? Um estudo transversal na atenção primária no Brasil. *Cad Saúde Pública*. 2017;33(8):1-8. <https://doi.org/10.1590/0102-311x00060916>
13. Lipschitz D. Screening for nutritional status in the elderly. *Prim Care*. 1994;21(1):55-67.
14. Ben-Noun L, Laor A. Relationship between changes in neck circumference and cardiovascular risk factors. *Exp Clin Cardiol*. 2006;11(1):14-20.
15. Sociedade Brasileira de Cardiologia. 7ª diretriz brasileira de hipertensão arterial. *Arq Bras Cardiol*. 2016.
16. Instituto Nacional de Câncer José Alencar Gomes da Silva. ABC do câncer: abordagens básicas para o controle do câncer. 5ª ed. Rio de Janeiro: Instituto Nacional de Câncer José Alencar Gomes da Silva; 2019.
17. Cunha TRS, Santiago ICA, Motta RST. Nutritional profile and its correlation with the main prognostic factors in women with breast cancer undergoing surgical treatment. *Mastology*. 2018;28(2):94-101. <https://doi.org/10.29289/2594539420180000380>
18. Queiroz SA, Sousa IM, Silva FRM, Lyra CDO, Fayh APT. Nutritional and environmental risk factors for breast cancer: a case-control study. *Sci Med*. 2018;28(2):1-8. <http://dx.doi.org/10.15448/1980-6108.2018.2.28723>
19. Mota JCMG, Martins KA, Mota JF, Freitas-Junior R. Excesso de peso e de gordura andróide em mulheres goianas recém-diagnosticadas com câncer de mama. *Rev Bras Mastologia*. 2016;26(2):50-5. <http://dx.doi.org/10.5327/Z201600020004RBM>
20. Souza NHA, Falcão LMN, Nour GFA, Brito J, Castro M, Oliveira M. Breast cancer in young women: an epidemiological study in northeastern Brazil. *Sanare*. 2017;16(2):60-7.
21. Cabral ALLV, Giatti L, Casale C, Cherchiglia ML. Social vulnerability and breast cancer: Differentials in the interval between diagnosis and treatment of women with different sociodemographic profiles. *Ciêns Saúde Coletiva*. 2019;24(2):613-22. <https://doi.org/10.1590/1413-81232018242.31672016>
22. Instituto Nacional de Câncer José Alencar Gomes da Silva. A situação do câncer de mama no Brasil: síntese de dados dos sistemas de informação. Brasil: Instituto Nacional de Câncer José Alencar Gomes da Silva; 2019.
23. World Cancer Research Fund, American Institute for Cancer Research. Diet, nutrition, physical activity and breast cancer. Continuous Update Project Expert Report 2018 [Internet]. World Cancer Research Fund; 2018 [accessado em 01 nov. 2019]. Available from: [dietandcancerreport.org](http://dietandcancerreport.org)
24. Macacu A, Autier P, Boniol M, Boyle P. Active and passive smoking and risk of breast cancer: a meta-analysis. *Breast Cancer Res Treat*. 2015;154(2):213-24. <https://doi.org/10.1007/s10549-015-3628-4>
25. Balekouzou A, Yin P, Pamatika C, Bekolo C, Nambei S, Djéintote M, et al. Reproductive risk factors associated with breast cancer in women in Bangui: a case-control study. *BMC Womens Health*. 2017;17(1):14. <https://doi.org/10.1186/s12905-017-0368-0>
26. Custódio IDD, Marinho EDC, Gontijo CA, Pereira TSS, Paiva CE, De Maia YCP. Impact of chemotherapy on diet and nutritional status of women with breast cancer: A prospective study. *PLoS One*. 2016;11(6):e0157113. <http://dx.doi.org/10.1371/journal.pone.0157113>
27. Boyle T, Vallance JK, Buman MP, Lynch BM. Reallocating time to sleep, sedentary time, or physical activity: associations with waist circumference and body mass index in breast cancer survivors. *Cancer Epidemiol Biomarkers Prev*. 2017;26(2):254-60. <https://dx.doi.org/10.1158%2F1055-9965.EPI-16-0545>
28. Santos EMC, Silva LML, Santos EMC, Souza LS. Associação entre o estado nutricional e a presença de toxicidade gastrointestinal em pacientes com câncer de mama. *Braspen J*. 2018;33(1):9-14.
29. Pacholczak R, Klimek-Piotrowska W, Kuzmiersz P. Associations of anthropometric measures on breast cancer risk in pre- and postmenopausal women—a case-control study. *J Physiol Anthropol*. 2016;35:7. <https://dx.doi.org/10.1186%2Fs40101-016-0090-x>
30. Vieira ACR, Sichieri R. Associação do status socioeconômico com obesidade. *Physis*. 2008;18(3):415-26. <http://dx.doi.org/10.1590/S0103-73312008000300003>
31. Ribeiro-Sousa MAS, Mastelaro I, Peria FM, Carrara HA, Andrade JM, Cunha SFC. Weight Gain during Systemic Oncologic Therapy for Breast Cancer: Changes in Food Intake and Physical Activity. *Rev Bras Cancerol*. 2019;65(2):1-7. <https://doi.org/10.32635/2176-9745.RBC.2019v65n2.360>



# Influence of breast cancer subtype on pathological complete response

Bruno de Carvalho Mancinelli<sup>1\*</sup>, Marcelo Antonini<sup>1</sup>,  
Flávia Vasconcelos da Silva<sup>1</sup>, Odair Ferraro<sup>1</sup>, Reginaldo Guedes Coelho Lopes<sup>1</sup>

## ABSTRACT

**Objective:** To compare the rates of pathological complete response (pCR) after treatment with neoadjuvant chemotherapy, in the different subtypes of breast cancer in patients followed at the Mastology Service of Hospital do Servidor Público Estadual. **Methods:** Descriptive and retrospective study, in which medical records of 213 patients diagnosed with breast cancer and submitted to neoadjuvant chemotherapy were reviewed, from February 2011 through January 2018. Histological data collected were: hormone receptors, hyperexpression of HER-2, grade, histological type and clinical data: age of the patient at diagnosis, tumor size and clinical stage at diagnosis and after chemotherapy, and rate of pCR. **Results:** The mean age of patients at diagnosis was 53.97 years. Forty-six patients (21,6%) had pCR, 77 (36.1%) were grade 2 and 136 (63.9%) were grade 3. Regarding cancer subtype, 29 patients (13.6%) were reported to have pure HER2 subtype, 48 patients (22.5%) corresponded to Luminal A subtype, 51 (23.9%) to Luminal B, and 66 patients (31.0%) were characterized as Triple Negative, while only 17 patients (7.9%) had Luminal B HER. **Conclusion:** The subtypes Pure HER 2 and Luminal B had the highest pCR rates.

**KEYWORDS:** breast cancer; combined modality therapy; chemotherapy.

## INTRODUCTION

Breast cancer is the most common type of cancer among women in the world and, in Brazil, is behind non-melanoma skin cancer, accounting for 28% of new cases each year. The National Cancer Institute estimates 66,280 new cases of breast cancer in Brazil for every 100 thousand inhabitants in 2020<sup>1</sup>.

All systemic therapies applied to non-metastatic breast cancer is intended to reduce the risk of distant recurrence. In addition, the objective its administration before surgery is to shrink the tumor, which may allow for less extensive surgery on the breast and/or armpit, increased conservative surgery instead of mastectomy, improved aesthetic results and reduced postoperative complications, such as lymphedema<sup>1,2</sup>. Neoadjuvant therapy also allows an early assessment of the effectiveness of systemic therapy. In addition, the presence or absence of residual invasive cancer after neoadjuvant chemotherapy (NACT) is a strong prognostic factor for the risk of recurrence, especially in triple negative breast cancer (TNBC) and positive human epidermal growth factor receptor 2 (HER2)<sup>3-6</sup>.

Although there is no consensus in the literature on what to consider a pathological complete response (pCR), we can define it as the absence of cancer (invasive or *in situ*) in both the breast and the armpit, identifying morphological findings in breast tissue that are consistent with regression of the neoplasia and define a possible tumor bed upon anatomopathological assessment<sup>7</sup>.

Breast cancer patients who present with pCR after NACT have a better prognosis when compared to those who have incomplete responses. The NSABP B-18 and NSABP B-27 studies compared NACT with adjuvant chemotherapy using Adriamycin with cyclophosphamide (CA) in isolation or associated with taxanes, and reported better disease-free survival (DFS) and overall survival (OS) in patients with pCR; however, the pCR rates were 13% and 26%, respectively. The final analysis failed to show which subgroups would benefit most from NACT to improve DFS and OS, and also did not show reduction in mortality<sup>8,9</sup>.

Different molecular subtypes respond differently, with TNBC and breast cancer with HER2 overexpression responding better than luminal subtypes. Immunotherapies, such as trastuzumab,

<sup>1</sup>Hospital do Servidor Público Estadual, Instituto de Assistência Médica ao Servidor Público Estadual de São Paulo – São Paulo (SP), Brazil.

\*Corresponding author: brunomancinelli@gmail.com

Conflict of interests: nothing to declare.

Received on: 02/18/2020. Accepted on: 06/02/2020.

and chemotherapeutic agents, such as anthracyclines and taxanes, are used in the search for better results in primary treatment of breast cancer<sup>10-12</sup>.

Given the importance of the topic, this study aims to compare the rates of pCR after NACT in different subtypes of breast cancer in patients followed at the Mastology outpatient clinic of a public hospital.

## METHODS

### Type of study and ethical aspect

This is a retrospective descriptive study comprising female patients followed up at the Mastology outpatient clinic of Hospital do Servidor Público Estadual — Francisco Morato de Oliveira (HSPE-FMO), between February 2011 and January 2018, with confirmed diagnosis of cancer and submitted to NACT. The project was approved by the Ethics and Research Committee and registered in “Plataforma Brasil” (Certificate of Presentation for Ethical Consideration—CAAE: 86418618.0.0000.5463).

### Study design and ethical aspect

Clinical and laboratory data of patients from medical records were reviewed: age, tumor size at diagnosis, clinical and pathological stage (TNM staging), hormone receptors (HR), HER2 overexpression, Ki-67 proliferation index, tumor grade and histological type at biopsy, and pCR. HR and HER2 overexpression were analyzed by quantitative immunohistochemistry (IHC). HER2 overexpression was considered positive only when the result on IHC was 3+ or with a positive Fluorescence In Situ Hybridization (FISH) test.

The Ki-67 proliferation index was used to differentiate the luminal subtypes and the value of 14% was considered as cutoff, that is, patients who presented only positive hormone receptors with Ki-67 below 14% were classified as Luminal A and above 14%, as Luminal B. The triple negative subtype (TNBC) was considered when estrogen receptors (ER), progesterone receptors (PR) and HER2 were all negative. Luminal B — HER2 (LB-HER) was defined when ER or PR were positive with high Ki-67 and HER2 overexpression. Finally, subtype pure HER2 (pure HER) was defined upon negative ER and PR and positive HER2.

All patients included in the analysis were properly screened with computed tomography of the chest and abdomen, and submitted to bone scintigraphy in order to exclude metastatic disease.

Patients submitted to NACT for inflammatory carcinoma were not included in the sample.

The sequence and schema of chemotherapy drugs were defined by the institution's attending physician, without central standardization. The main antineoplastic agents used were: adriamycin, cyclophosphamide, docetaxel and trastuzumab, the latter only in patients with HER2 overexpression.

In patients receiving trastuzumab as neoadjuvant therapy, the drug was maintained for 18 cycles. For these patients, transthoracic echocardiography was performed to assess cardiac function every 12 weeks.

In this study, absence of invasive or in situ residual tumor in the breast and armpit was considered as pCR<sup>7</sup>.

Ten patients were excluded from the sample: seven did not have a sequential NACT scheme and three died, which results in medical records not being released for analysis.

An informed consent form was not required, as the paper resulted from medical records' review and patients did not have their identity revealed.

### Statistical analysis

The  $\chi^2$  test was used to analyze the association between pCR and the independent variables, as well as pCR rates in different types of tumor. To assess the epidemiological profile of patients with different histological types, univariate analysis was applied.

The simple logistic regression model was applied to assess odds ratio between the dependent variable pCR and independent variables. Multidimensional data were analyzed using the multiple correspondence factor analysis technique in order to assess associations. Statistical analysis was performed on the software R 3.4.2, with significance level set at below 5%.

## RESULTS

The sample had 213 patients who underwent chemotherapy and were evaluated. The mean age was  $54 \pm 9$  years, with age range between 29 and 72 years (median of 54 years).

The pCR was present in 22.6% ( $n = 46$ ), while 36.1% ( $n = 77$ ) presented stage II and 63.9% ( $n = 136$ ) stage III. As for the histological grade of tumors, 9.3% ( $n = 20$ ) of patients had grade I, 53% ( $n = 113$ ) grade II and 37.7% ( $n = 80$ ) grade III. As for cancer subtype, 22.5% of patients had Luminal A subtype, 23.9% Luminal B, 7.9% LB-HER, 31% TNBC and 13.6% pure HER subtype.

Conservative surgery was possible in 59% of cases. However, axillary emptying was necessary in 89.3% of cases (Table 1).

When checking pCR in molecular subtypes, responses varied between 10 and 41%, with the worst responses for Luminal A and B and tumors with HER2 overexpression with a higher prevalence of pCR.

The analysis of subgroups identified an association of the pCR in patients with pure HER and LB-HER with the histological grade (Table 2).

Table 2 shows that the highest pCR rates were found in grade II and III tumors, those with negative HR and positive HER. The only subtype that did not follow this trend was Luminal A.

## DISCUSSION

In this study, 46 patients (22.6%) reached a pCR, but this was less frequent in subtypes LA and LB: 10.4% and 11.8%, respectively. In TNBC, pCR was reached in 24.2% of cases. In patients with HER2 overexpression, pCR was observed in 41.2% of LB-HER cases and 37.9% in patients without HR expression. Similar results were found by Monteiro et al.<sup>13</sup>, which suggests that the tumor response to NACT is not affected by systemic comorbidities, but rather influenced negatively by HR expression.

Despite the subtype LA being the most prevalent breast tumor in the literature<sup>4,7</sup>, in this study its prevalence was lower than other subtypes (for example, TNBC). As it presents a good response to adjuvant hormonal treatment<sup>9</sup>, its first treatment is surgery, especially when found in early stages.

In our sample, only 46 patients (22.6%) reached a pCR, which corroborates the meta-analysis by Spring et al.<sup>7</sup>, with 18,000 patients reaching the pCR in 21.5% of cases.

Of the total number of patients evaluated, 63.1% were in stage 3, similar to the studies that evaluated the indication of NACT in locally advanced stages, aiming at less aggressive surgical approaches<sup>14</sup>. In addition, 53% had histological grade II, similar to what Lopes et al.<sup>15</sup> and Aquino et al.<sup>16</sup> reported: 56.6% and 52.2%, respectively. The lower percentage of grade I (9.3%) can be explained by the higher incidence of positive TN and HER2 subtypes, which, in general, are more prone to higher histological grades (II and III).

Of 213 patients evaluated, conservative surgery was possible in 59.0% of the cases, which corroborates data from the literature, in which NACT has become an alternative to expand the

**Table 1.** Characteristics of patients in relation to the presence or absence of pathological complete response (pCR).

	No pCR n (%)	pCR n (%)	OR (95%CI)	p-value
<b>Receptor</b>				
ER and PR+	81 (48.5)	16 (34.8)	1	0.035
ER+	13 (7.8)	0 (0.0)	1.19 (0.00–inf)	
PR+	6 (3.6)	3 (6.5)	2.53 (0.57–11.17)	
ER and PR-	67(40.1)	27 (58.7)	2.04 (1.01–4.10)	
<b>Tumor type</b>				0.004
LA	43 (25.9)	5 (11.1)	0.19 (0.06–0.63)	
LB	45 (27.1)	6 (13.3)	0.22 (0.07–0.68)	
LB-HER	10 (6.0)	7 (15.6)	1.15 (0.34–3.89)	
Pure HER	18 (10.8)	11 (24.4)	1.00	
TNBC	50 (30.1)	16 (35.6)	0.52 (0.2–1.34)	
<b>Nuclear grade</b>				0.342
I	18 (10.8)	2 (4.3)	1.00	
II	89 (53.3)	24 (52.2)	2.43 (0.53–11.19)	
II	60 (35.9)	20 (43.5)	3.00 (0.64–14.08)	

OR: odds ratio; 95%CI: 95% confidence interval; ER: estrogen receptor; PR: progesterone receptor; + positive; - negative; LA: luminal A; LB: luminal B; LB-HER: luminal B – HER2; Pure HER: pure HER2; TNBC: triple negative breast cancer.

**Table 2.** Characteristics of the subtypes in relation to the pathological complete response (pCR) and nuclear grade.

	Pure HER	LA	LB	LB-HER	TNBC	p-value
	n (%)	n (%)	n (%)	n (%)	n (%)	
<b>N</b>	29	48	51	17	66	
<b>pCR</b>	11 (37.9)	5 (10.4)	6 (11.8)	7 (41.2)	16 (24.2)	0.004
<b>Grade (%)</b>						
I	0 (0.0)	10 (20.8)	5 (9.8)	1 (5.9)	4 (6.1)	< 0.001
II	14 (48.3)	32 (66.7)	32 (62.7)	9 (52.9)	25 (37.9)	
III	15 (51.7)	6 (12.5)	14 (27.5)	7 (41.2)	37 (56.1)	

Pure HER: pure HER2; LA: luminal A; LB: luminal B; LB-HER: luminal B – HER2; TNBC: triple negative breast cancer.

indication of conservative surgery in patients who, initially, are not candidates for the procedure. Axillary emptying was necessary in 89.3% of cases, similar results reported by Van Vaisberg et al.<sup>17</sup>, in which 85% of patients were submitted to axillary emptying. Such data can be explained by the higher percentage of advanced stages and, in addition, during the sample collection period, axillary emptying was the choice in the case of clinically compromised armpits (N1+). Mamtani et al.<sup>6</sup> and Donker et al.<sup>18</sup> found that, with the increase in indications for sentinel lymph node biopsy in cases of clinical response in the axilla, axillary emptying rates were reduced by 60%.

It is known that the NACT response is greater in tumors with negative ER, TN, positive HER2. We could observe that the pure HER2 (37.9%) and luminal B HER (41.2%) subtypes presented the highest pCR rates. Data reported by Boughey et al.<sup>19</sup> and Silva et al.<sup>20</sup> confirm similar values (45.4%).

In our study, no dual anti-HER2 therapy was performed in a neoadjuvant environment. As per publication by Nitz et al.<sup>21</sup>, it is known that pCR rates for tumors with HER2 overexpression can reach up to 70%.

In TNBC, the rate of 24.2% of pCR was lower than that reported by Spring et al.<sup>7</sup> in their meta-analysis; however, it should be noted that the lack of standardization of NACT schemes observed in this sample may have influenced the pCR rate verified in this study, bringing limitations to the comparison with current references.

Therefore, it should be noted that the limitations of this study stem from the lack of standardized schemes for NACT, which makes it difficult to compare pCR rates in different breast cancer subtypes. In addition, some of the drugs used in major world centers were not available at the hospital chosen for assessment, making the pCR rate of some subtypes (for example tumors with HER2 overexpression) lower than current data. Further studies are suggested, with the standardization of chemotherapy schemes and the use of new drugs already approved.

## CONCLUSION

Although the pCR rate varies according to breast cancer subtype, pure HER2 and luminal B HER2 subtypes were the ones with the highest rates.

## REFERENCES

1. Brasil. Ministério da Saúde. Tipos de câncer: câncer de mama [Internet]. Brasil: Instituto Nacional do Câncer [accessed on July 17, 2017]. Available at: [http://www2.inca.gov.br/wps/wcm/connect/tiposdecancer/site/home/mama/cancer\\_mama](http://www2.inca.gov.br/wps/wcm/connect/tiposdecancer/site/home/mama/cancer_mama)
2. Bardia A, Baselga J. Neoadjuvant therapy as a platform for drug development and approval in breast cancer. *Clin Cancer Res.* 2013;19(23):6360-70. <https://doi.org/10.1158/1078-0432.ccr-13-0916>
3. Ueno NT, Buzdar AU, Singletary SE, Ames FC, McNeese MD, Holmes FA, et al. Combined-modality treatment of inflammatory breast carcinoma: Twenty years of experience at M.D. Anderson Cancer Center. *Cancer Chemother Pharmacol.* 1997;40(4):321-9. <https://doi.org/10.1007/s002800050664>
4. Pachnick JPA, Czezko NG, Tuon F, Cavalcanti TS, Malafaia AB, Tuleski AM. Avaliação imunistoquímica dos receptores de estrogênio e progesterona no câncer de mama, pré e pós-quimioterapia neoadjuvante. *Rev Col Bras Cir.* 2012;39(2):86-91. <https://doi.org/10.1590/S0100-69912012000200002>
5. Schwartz GF, Hortobagyi GN. Proceedings of the consensus conference on neoadjuvant chemotherapy in carcinoma of the breast, April 26-28, 2003, Philadelphia, Pennsylvania. *Cancer.* 2004;100(12):2512-32. <https://doi.org/10.1002/cncr.20298>
6. Mamtani A, Barrio AV, King TA, Van Zee KJ, Plitas G, Pilewskie M, et al. How Often Does Neoadjuvant Chemotherapy Avoid Axillary Dissection in Patients With Histologically Confirmed Nodal Metastases? Results of a Prospective Study. *Ann Surg Oncol.* 2016;23(11):3467-74. <https://dx.doi.org/10.1245%2Fs10434-016-5246-8>
7. Spring L, Greenup R, Niemierko A, Schapira L, Haddad S, Jimenez R, et al. Pathologic complete response after neoadjuvant chemotherapy and long-term outcomes among young women with breast cancer. *J Natl Compr Cancer Netw.* 2017;15(10):1216-23. <https://doi.org/10.6004/jnccn.2017.0158>
8. Rastogi P, Anderson SJ, Bear HD, Geyer CE, Kahlenberg MS, Robidoux A, et al. Preoperative chemotherapy: Updates of national surgical adjuvant breast and bowel project protocols B-18 and B-27. *J Clin Oncol.* 2008;26(5):778-85. <https://doi.org/10.1200/jco.2007.15.0235>
9. Gralow JR, Burstein HJ, Wood W, Hortobagyi GN, Gianni L, Von Minckwitz G, et al. Preoperative therapy in invasive breast cancer: Pathologic assessment and systemic therapy issues in operable disease. *J Clin Oncol.* 2008;26(5):814-9. <https://doi.org/10.1200/jco.2007.15.3510>
10. Cortazar P, Zhang L, Untch M, Mehta K, Costantino JP, Wolmark N, et al. Pathological complete response and long-term clinical benefit in breast cancer: The CTNeoBC pooled analysis. *Lancet.* 2014;384(9938):164-72. [https://doi.org/10.1016/s0140-6736\(13\)62422-8](https://doi.org/10.1016/s0140-6736(13)62422-8)
11. Carey LA, Dees EC, Sawyer L, Gatti L, Moore DT, Collichio F, et al. The triple negative paradox: Primary tumor chemosensitivity of breast cancer subtypes. *Clin Cancer Res.* 2007;13(8):2329-34. <https://doi.org/10.1158/1078-0432.ccr-06-1109>
12. Precht LM, Lowe KA, Atwood M, Beatty JD. Neoadjuvant chemotherapy of breast cancer: Tumor markers as predictors of pathologic response, recurrence, and survival. *Breast J.* 2010;16(4):362-8. <https://doi.org/10.1111/j.1524-4741.2010.00935.x>



13. Monteiro H de AV, Goulart-Citrangulo SMT, Leite MS, Giacomini LC, Vianna-Jorge R. Influência de Variáveis Clinicopatológicas sobre a Eficácia da Quimioterapia Neoadjuvante do Câncer de Mama. *Rev Bras Cancerol.* 2013;59(3):369-77.
14. Santos TP, Paes MA, Ferreira ACS de M, Campos T. Avaliação epidemiológica das pacientes com câncer de mama tratadas com trastuzumabe no Hospital de Base de Brasília. *Rev Bras Oncol Clínica.* 2014;10(36):55-9.
15. Lopes LAF, Linhares, JJ, Ferraro O, Guedes R, Lopes C, Baracat FF. Valor prognóstico do grau histológico (GH), grau nuclear (GN) e índice mitótico (IM) para pacientes com carcinoma da mama estádios II e III com linfonodos axilares comprometidos. *Rev Bras Cancerol.* 2006;52(3):245-51.
16. Aquino RGF de, Pinheiro LGP, Cavalcante DIM, Vasques PHD, Oliveira AL de S, Silva CAB da. Carcinoma ductal invasor: comparação dos graus histológicos entre tumor primário e metástase axilar. *Rev Bras Mastol.* 2016;26(2):45-9.
17. Van Vaisberg V, Vilas Boas MDS, Stephan BDO, Matutino ARB, Lima JMDS, Mano MS. Câncer de mama: efeito prognóstico da resposta patológica completa após quimioterapia neoadjuvante. *Rev Med.* 2015;94(Supl.):31. <https://doi.org/10.11606/issn.1679-9836.v94isupl.p31-31>
18. Donker M, van Tienhoven G, Straver ME, Meijnen P, van de Velde CJH, Mansel RE, et al. Radiotherapy or surgery of the axilla after a positive sentinel node in breast cancer (EORTC 10981-22023 AMAROS): A randomised, multicentre, open-label, phase 3 non-inferiority trial. *Lancet Oncol.* 2014;15(12):1303-10. [http://dx.doi.org/10.1016/S1470-2045\(14\)70460-7](http://dx.doi.org/10.1016/S1470-2045(14)70460-7)
19. Boughey JC, Suman VJ, Mittendorf EA, Ahrendt GM, Wilke LG, Taback B, et al. Sentinel lymph node surgery after neoadjuvant chemotherapy in patients with node-positive breast cancer: The ACOSOG Z1071 (alliance) clinical trial. *J Am Med Assoc.* 2013;310(14):1455-61. <https://dx.doi.org/10.1001%2Fjama.2013.278932>
20. Silva EHL de S, Paloschi JRA, Caldeira JR de F, Joioso A. Estudo comparativo de resposta à quimioterapia neoadjuvante em dose total, entre câncer de mama e metástase axilar, conforme resultados de imunohistoquímica, no Serviço de Mastologia do Hospital Amaral Carvalho em Jaú, SP. *Rev Bras Mastol.* 2015;25(2):46-50. <https://dx.doi.org/10.5327/Z201500020003RBM>
21. Nitz U, Gluz O, Christgen M, Grischke EM, Augustin D, Kümmel S, et al. Final analysis of WSG-ADAPT HER2+/HR- trial: Efficacy, safety, and predictive markers for 12-weeks of neoadjuvant dual blockade with trastuzumab + pertuzumab ± weekly paclitaxel in HER2+/HR- early breast cancer (EBC). *J Clin Oncol.* 2016;34(15 Supl.):518. [https://dx.doi.org/10.1200/JCO.2016.34.15\\_suppl.518](https://dx.doi.org/10.1200/JCO.2016.34.15_suppl.518)



# Opportunistic mammography screening by the Brazilian Unified Health System in 2019

Ruffo Freitas-Junior<sup>1,2\*</sup> , Danielle Cristina Netto Rodrigues<sup>1,2</sup> ,  
Rosângela Silveira Corrêa<sup>1,2</sup> , Luis Fernando Pádua Oliveira<sup>1,2</sup> , Lilian Soares Couto<sup>1</sup> ,  
Linei Augusta Brolini Dellê Urban<sup>3</sup> , Rosemar Macedo Sousa Rahal<sup>1,2</sup> 

## ABSTRACT

**Introduction:** Mammography screening has been the best method for detecting early tumors and reducing breast cancer mortality according to different studies. In Brazil, the number of women who undergo mammography tests by the Brazilian Unified Health System (SUS) has been far below international recommendations. **Objective:** To describe the number of mammographies, mammography coverage, and the amount spent on this exam during 2019 by SUS, in Brazil. **Method:** Ecological study with data from the Department of Informatics of the Brazilian Unified Health System and the Brazilian Institute for Geography and Statistics in order to verify the number of mammographies performed by the SUS concerning the Brazilian female population in Brazil, in the age group of 50 to 69 years, in the states and in macro-regions during 2019. **Results:** In 2019, 2,660,469 mammographies were performed in the country out of the expected total of 12,154,979, accounting for a 21.9% mammography coverage by SUS at the cost of BRL 117,841,231.97. The lowest coverage rates were verified in the states of Amapá (0.6%) and the Federal District (4.9%), whereas the best rates were found in the states of Paraná (29.7%) and Alagoas (29.6%). **Conclusions:** The number of mammographies performed in Brazil in 2019 by SUS corresponded to almost ¼ of the country's need, with mammography coverage far below the target and being widely different among the many Brazilian states.

**KEYWORDS:** breast neoplasms; mass screening; mammography; Brazilian Unified Health System; Brazil.

## INTRODUCTION

Mammography has been the most appropriate method for screening breast cancer to date, consisting in the only method that has shown a reduction in mortality from breast neoplasm<sup>1</sup>, reduction in tumor size at diagnosis, and increased survival in patients who developed this type of cancer<sup>2</sup>. However, despite all the benefits, there are several criticisms regarding this method. Among them, we can mention: the non-reduction in the rate of cases of de novo stage IV breast cancer, the increase in detected cases that would not require treatment, in addition to the possibility of an increase in the number of cases of radiation-induced cancer<sup>3,4</sup>.

Despite this worldwide discussion, the impossibility of detecting more aggressive tumors, including cases of interval cancer<sup>5</sup>, together with the great difficulty of access to health services that exists in Brazil<sup>6</sup>, certainly makes the model of opportunistic breast cancer screening to not be fully adopted

in the country yet, with an effective reduction in mortality, as previously published<sup>7,8</sup>.

In a recent study conducted by the *Rede Brasileira de Pesquisa em Câncer de Mama* [Brazilian Breast Cancer Research Network], following the recommendations of the Brazilian Ministry of Health, according to which women aged between 50 and 69 years must undergo a biennial mammography examination, it was observed that the rate of mammography coverage by the Brazilian Unified Health System (SUS) in this population increased from 14.4% in 2008 to 24.4% in 2012 and, since then, mammography coverage has been stabilized, accounting for 24.2% in 2017<sup>9</sup>.

These numbers must be updated for 2019 and, therefore, the objective of this study was to analyze data from the Department of Informatics of the Brazilian Unified Health System (DATASUS) for the year 2019, considering, in addition to the absolute number of mammographies, the mammography coverage and the amount spent by SUS on these exams in 2019.

<sup>1</sup>Breast Cancer Program, Hospital das Clínicas, Universidade Federal de Goiás – Goiânia (GO), Brazil.

<sup>2</sup>Brazilian Breast Cancer Research Network – Goiânia (GO), Brazil.

<sup>3</sup>National Mammography Commission, Colégio Brasileiro de Radiologia – São Paulo (SP), Brazil.

\*Corresponding author: ruffojr@terra.com.br

Conflict of interest: nothing to declare.

Received on: 05/04/2020. Accepted on: 06/01/2020.

## METHODS

### Study design

This is an ecological, descriptive study, with secondary data from the Brazilian Ambulatory Information System (SIA/DATASUS) and the Brazilian Institute for Geography and Statistics (IBGE) for 2019.

### Target population

Women aged 50 to 69 years were considered the target population. Data on the number of surveyed women for the period from January 1 to December 31, 2019 were collected from SIA/DATASUS<sup>10</sup>. The IBGE projection of the Brazilian population for the year 2019 was considered<sup>11</sup>.

### Coverage estimates

Mammography coverage was estimated considering the biennial screening in order to reach 100% of the target population. It was expressed as percentage and calculated using the ratio between the number of performed tests and the number of expected tests.

Data on the number of tests performed from January 1 to December 31, 2019 were collected from SIA/DATASUS, according to procedure codes 0204030030 (Mammography) and 0204030188 (Bilateral Mammography for Screening).

To estimate the number of tests expected in the population aged 50 to 69 years, the recommendation of the National Cancer Institute José Alencar Gomes da Silva (INCA) was adopted. In scheduling procedures, it is necessary to predict that, in a given year, 50% of women aged 50 to 69 years shall undergo screening through clinical breast exam, in addition to a diagnostic mammography in 8.9% of this population, who will have an altered clinical breast exam; while the other 50% of women shall undergo a clinical breast exam and mammography screening, regardless of the result in the clinical breast exam<sup>12</sup>.

## RESULTS

According to data collected from SIA/DATASUS, in 2019 a total of 2,660,469 mammographies were performed in the country out of the expected total of 12,154,979, accounting for a 21.9% mammography coverage by SUS at the cost of BRL 117,841,231.97, as demonstrated in Table 1. Each of the values was repeated for the Brazilian states, the Federal District, and the country's macro-regions.

## DISCUSSION

In addition to the current model of mammography screening used worldwide, performed by mammography and complemented by other exams, including breast ultrasound and breast magnetic resonance imaging, in cases of high-risk patients<sup>1,2,13</sup>, we observed that some situations must be remedied if the current model prevails. The first one involves remedying the low productivity of mammography

machines available at SUS. In a recent study conducted by the Brazilian Breast Cancer Research Network, the extremely low productivity of the machines was observed, which shows that, in the country, there is no lack of mammography equipment, but rather of an efficient operation in all states, considering that the effectiveness ranged between 1% in the Federal District to 40% in the state of Bahia<sup>14</sup>. These numbers evidence the urgent need to reorganize several services related to SUS, which alone can promote a considerable improvement in mammography coverage for SUS users.

Another aspect that must be addressed is the issue of bureaucracy in undergoing the mammography test by SUS. In places where there is an organized population screening, women in the age group in question receive an invitation letter to do the mammography, and that is enough for them to undergo the exam. Then, the test result is evaluated by a doctor and they receive a new letter informing the result and already scheduling a new exam for the next round of tests, as recommended in different countries<sup>5,15</sup>. In Brazil, despite financial and time-related difficulties existing among the population served at SUS, women must first have a medical prescription for undergoing a mammography, which is usually prescribed by doctors working in Health Units or, eventually, in the Family Health Strategy program, which is a Brazilian program aiming at reorganizing primary health-care services, promoting the quality of life of the Brazilian population, and preventing factors that pose risk to their health. Then, they must go to a location selected by the Brazilian Department of Health to get an authorization for undergoing procedures of low-to-medium complexity, and only then they shall schedule the mammography. Another time, these women will spend more time undergoing the exam. As if that were not enough, they must get the test result and then take it to a doctor. Only based on the exam the professional can reassure them or, when necessary, request some complementary exam such as imaging tests or even biopsy.

In Flanders, Belgium, for women aged between 50 and 69 years, the debureaucratization and change from an opportunistic screening to an organized, biennial screening model increased mammography coverage from 14%, in 2002, to 64%, in 2016<sup>5</sup>. This indicates that such organized and unbureaucratic model may be a good option for the Brazilian public health.

The clear need for improving the quality of the exams itself cannot be disregarded. Accordingly, the increase in radiation levels and the patient's poor positioning on the mammography machine are factors that have been observed and that, among others, may generate the poor quality of the mammography, increasing the possibility of false-negative mammograms, as well as false-positive ones, and further reducing the accuracy of the exam in its general context<sup>16,17</sup>.

Concerning the mammography coverage, the year 2019 reflects what happened in the previous years, from 2012 to 2017<sup>9</sup>, when there was no increase in mammography coverage in the female population aged 50 to 69 years who use the SUS services. This probably reflects a political issue, with greater emphasis on the economic and financial situation in which Brazil was immersed in the period under analysis.

**Table 1.** Resident population, number of tests expected and performed, mammography coverage, and value approved by the Brazilian Unified Health System (SUS), in Brazil and in the states, in 2019.

Federation Unit / Macro-region	Resident population	No. of expected tests	No. of performed tests	Coverage	Approved value in Brazilian currency (BRL)
Rondônia	142,254	83,788	7,053	8.4	282,271.40
Acre	50,350	29,656	4,983	16.8	216,135.00
Amazonas	251,965	148,407	20,233	13.6	903,645.20
Roraima	31,838	18,753	2,544	13.6	112,270.40
Pará	569,845	335,639	28,818	8.6	1,272,678.90
Amapá	45,579	26,846	149	0.6	6,230.20
Tocantins	114,284	67,313	5,899	8.8	256,145.50
<b>North Region</b>	<b>1,206,115</b>	<b>710,402</b>	<b>69,679</b>	<b>9.8</b>	<b>3,049,376.60</b>
Maranhão	486,906	286,788	25,127	8.8	1,101,064.05
Piauí	286,053	168,485	39,231	23.3	1,891,496.80
Ceará	797,849	469,933	53,040	11.3	2,337,265.40
Rio Grande do Norte	321,350	189,275	34,222	18.1	1,705,435.60
Paraíba	370,021	217,942	37,873	17.4	1,697,252.30
Pernambuco	885,113	521,332	129,864	24.9	5,743,554.65
Alagoas	279,667	164,724	48,723	29.6	2,185,020.40
Sergipe	195,138	114,936	22,847	19.9	1,023,714.80
Bahia	1,253,851	738,518	207,571	28.1	10,703,861.41
<b>Northeast Region</b>	<b>4,981,403</b>	<b>2,934,046</b>	<b>598,498</b>	<b>20.4</b>	<b>28,388,665.41</b>
Minas Gerais	2,233,182	1,315,344	311,008	23.6	13,363,522.17
Espírito Santo	406,091	239,188	58,817	24.6	2,571,096.00
Rio de Janeiro	1,987,179	1,170,448	170,219	14.5	7,338,582.60
São Paulo	4,982,976	2,934,973	817,050	27.8	35,369,659.45
<b>Southeast Region</b>	<b>9,609,428</b>	<b>5,659,953</b>	<b>1,357,094</b>	<b>24.0</b>	<b>58,642,860.22</b>
Paraná	1,233,399	726,472	215,671	29.7	9,483,834.50
Santa Catarina	751,272	442,499	101,027	22.8	4,392,800.90
Rio Grande do Sul	1,369,087	806,392	212,135	26.3	9,232,842.64
<b>South Region</b>	<b>3,353,758</b>	<b>1,975,363</b>	<b>528,833</b>	<b>26.8</b>	<b>23,109,478.04</b>
Mato Grosso do Sul	258,313	152,146	28,194	18.5	1,207,360.50
Mato Grosso	287,850	169,544	19,025	11.2	841,474.00
Goías	644,129	379,392	50,684	13.4	2,230,190.10
Federal District	295,640	174,132	8,462	4.9	371,827.10
<b>Midwest Region</b>	<b>1,485,932</b>	<b>875,214</b>	<b>106,365</b>	<b>12.2</b>	<b>4,650,851.70</b>
<b>Brazil</b>	<b>20,636,636</b>	<b>12,154,979</b>	<b>2,660,469</b>	<b>21.9</b>	<b>117,841,231.97</b>

Hence, the year 2019 clearly indicates the need for greater allocation of financial and, mainly, organizational resources, in order to increase the number of mammographies performed in the country. This adjustment should include the reduction in the existing bureaucracy for undergoing the exam, as well as the improvement in the promptness of each step, in such a way that women do not waste time with so many steps and can access the diagnosis quickly and effectively.

## AUTHORS' CONTRIBUTION

R.F.-J., D.C.N.R., R.S.C., L.F.P.C., L.S.C., L.A.B.D.U., R.M.S.R.: Concept, research, methodology.

R.F.-J., D.C.N.R.: Data processing, formal analysis, writing of the article and its first version.

R.S.C., L.F.P.C., L.S.C., L.A.B.D.U., R.M.S.R.: Data validation, methodology review, writing review and editing.

R.F.-J., D.C.N.R., R.S.C., L.F.P.C., L.S.C., L.A.B.D.U., R.M.S.R.: Review and approval of the final version.

## REFERENCES

- Dibden A, Offman J, Duffy SW, Gabe R. Worldwide Review and Meta-Analysis of Cohort Studies Measuring the Effect of Mammography Screening Programmes on Incidence-Based Breast Cancer Mortality. *Cancers*. 2020;12(4):976. <http://doi.org/10.3390/cancers12040976>
- Gøtzsche PC, Jørgensen KJ. Screening for breast cancer with mammography. *Cochrane Database Syst Rev*. 2013;6:CD001877. <http://doi.org/10.1002/14651858.CD001877.pub5>
- Dos-Santos-Silva I, De Stavola BL, Renna-Junior NL, Nogueira MC, Aquino EML, Bustamante-Teixeira MT, et al. Ethnoracial and social trends in breast cancer staging at diagnosis in Brazil, 2001-14: a case only analysis. *Lancet Glob Health*. 2019;7(6):e784-e797. [https://doi.org/10.1016/s2214-109x\(19\)30151-2](https://doi.org/10.1016/s2214-109x(19)30151-2)
- Pauwels EK, Foray N, Bourguignon MH. Breast Cancer Induced by X-Ray Mammography Screening? A Review Based on Recent Understanding of Low-Dose Radiobiology. *Med Princ Pract*. 2016;25(2):101-9. <https://doi.org/10.1159/000442442>
- Goossens M, De Brabander I, De Grève J, Van Ongeval C, Martens P, Van Limbergen E, et al. BMC Cancer. Flemish breast cancer screening programme: 15 years of key performance indicators (2002-2016). 2019;19:1012. <https://doi.org/10.1186/s12885-019-6230-z>
- Freitas-Junior R, Rodrigues DCN, Corrêa RS, Peixoto JE, Oliveira HVCG, Rahal RMS. Contribution of the Unified Health Care System to mammography screening in Brazil, 2013. *Radiol Bras*. 2016;49(5):305-10. <https://doi.org/10.1590/0100-3984.2014.0129>
- Gonzaga CMR, Freitas-Junior R, Souza MR, Curado MP, Freitas NMA. Disparities in female breast cancer mortality rates between urban centers and rural areas of Brazil: Ecological time-series study. *Breast*. 2014;23(2):180-7. <https://doi.org/10.1016/j.breast.2014.01.006>
- Gonzaga CMR, Freitas-Junior R, Curado MP, Sousa ALL, Souza-Neto JA, Souza MR. Temporal trends in female breast cancer mortality in Brazil and correlations with social inequalities: ecological time-series study. *BMC Public Health*. 2015;15:96. <https://doi.org/10.1186/s12889-015-1445-7>
- Rodrigues DCN, Freitas-Junior R, Rahal RMS, Silveira Corrêa R, Gouveia PA, Peixoto JE, et al. Temporal changes in breast cancer screening coverage provided under the Brazilian National Health Service between 2008 and 2017. *BMC Public Health*. 2019;19(1):959. <https://doi.org/10.1186/s12889-019-7278-z>
- Brasil. Ministério da Saúde. Departamento de Informática do SUS – DATASUS. Informações de Saúde (TABNET). Demográficas e Socioeconômicas [Internet]. Brasília: Ministério da Saúde; 2019 [accessed on Apr. 14, 2019]. Available at: <http://tabnet.datasus.gov.br/cgi/deftohtm.exe?ibge/cnv/popuf.def>
- Brasil. Instituto Brasileiro de Geografia e Estatística. Diretoria de Pesquisas. Coordenação de População e Indicadores Sociais. Gerência de Estudos e Análises da Dinâmica Demográfica. Projeção da população do Brasil e Unidades da Federação por sexo e idade para o período 2000-2030 [Internet]. Brasília: Ministério da Saúde [accessed on Apr. 14, 2019]. Available at: <http://www.ibge.gov.br/home/estatistica/populacao/>
- Brasil. Ministério da Saúde. Parâmetros técnicos para o rastreamento do câncer de mama: recomendações para gestores estaduais e municipais [Internet]. Rio de Janeiro: INCA; 2009 [accessed on Apr. 30, 2019]. Available at: [http://bvsmms.saude.gov.br/bvs/publicacoes/parametros\\_rastreamento\\_cancer\\_mama.pdf](http://bvsmms.saude.gov.br/bvs/publicacoes/parametros_rastreamento_cancer_mama.pdf)
- Urban LABD, Chala LF, Bauab SDP, Schaefer MB, Dos Santos RP, Maranhão NMA, et al. Breast cancer screening: updated recommendations of the Brazilian College of Radiology and Diagnostic Imaging, Brazilian Breast Disease Society, and Brazilian Federation of Gynecological and Obstetrical Associations. *Radiol Bras*. 2017;50(4):244-9. <https://doi.org/10.1590/0100-3984.2017-0069>
- Rodrigues DCN, Freitas-Junior R, Rahal RMS, Correa RS, Peixoto JE, Ribeiro NV, et al. Difficult Access and Poor Productivity: Mammography Screening in Brazil Asian Pac J Cancer Prev. 2019;20(6):1857-64. <https://doi.org/10.31557/apjcp.2019.20.6.1857>
- Moss SM, Wale C, Smith R, Evans A, Cuckle H, Duff SW. Effect of mammographic screening from age 40 years on breast cancer mortality in the UK Age trial at 17 years' follow-up: a randomised controlled trial. *Lancet Oncol*. 2015;16(9):1123-32. [https://doi.org/10.1016/s1470-2045\(15\)00128-x](https://doi.org/10.1016/s1470-2045(15)00128-x)
- Corrêa RS, Freitas-Junior R, Peixoto JE, Netto-Rodrigues DC, Lemos MEF, Dias CM, et al. Effectiveness of a quality control program in mammography for the Brazilian National Health System. *Rev Saúde Pública*. 2012;46(5):769-76. <http://dx.doi.org/10.1590/S0034-89102012000500002>
- Soares LR, Rahal RMS, Queiroz VCJ, Aquino EC, Correa RS, Rodrigues DCN, et al. Clinical quality Control of mammograms evaluated in a Brazilian tertiary Hospital. *Mastology*. 2018;28(Suppl. 1):6. <https://doi.org/10.29289/259453942018V28S1008>



# Clinical and surgical evaluation of gynecomastia: tactic and results

Darley de Lima Ferreira Filho<sup>1\*</sup> , Nancy Cristina Ferraz de Lucena Ferreira<sup>1</sup> , Thais de Lucena Ferreira<sup>2</sup> 

## ABSTRACT

**Objectives:** To perform an assessment of the clinical and surgical characteristics of gynecomastia as a tactic used and the results obtained in the breast. **Methods:** A prospective and observational study was carried out in the mastology service of Hospital Barão de Lucena in 40 patients. To determine which factors are associated with the cosmetic outcome, the contingency table was constructed and the  $\chi^2$  test for independence was applied. In cases in which the assumptions of the  $\chi^2$  test were violated, Fisher's exact test was applied. **Results:** Findings showed that most patients were from the metropolitan region of Recife (72.5%), studied until high school (62.5%), were aged 10 to 20 (42.5%), were in gynecomastia grade III (47.5%), underwent double incision (52.5%), had no complications (75.0%), and had a good and excellent cosmetic outcome (75.0%). The proportion comparison test was significant in all factors evaluated ( $p < 0.05$ ), except for the variable level of education ( $p = 0.114$ ), indicating that the numbers of patients who studied until high school and had higher education are close. The independence test was significant only in the variable complications ( $p < 0.001$ ), indicating that having complications significantly increases the risk for regular/bad cosmetics. **Conclusion:** Gynecomastia is a pathology of strong social impact. We observed this after analyzing the epidemiological, clinical, and surgical characteristics of our patients. In patients who underwent surgical treatment and who had no complications, there was a greater degree of satisfaction.

**KEYWORDS:** man; surgery; estrogen; breasts.

## INTRODUCTION

Gynecomastia was conceptualized by Galeno in the 2nd century BC, who defined it as a fatty accumulation in the man's breast.<sup>1</sup>

Its incidence in the world population is still unknown. However, there are peaks of incidence in newborns between 60 and 90%, presenting a transient development at puberty, beginning at 10 years of age and with a greater peak between 13 and 14. In the adult population, there is more prevalence approximately at 50 years of age, which is maintained until the 8<sup>th</sup> decade of life.<sup>3,4</sup> According to Medeiros, there is an incidence of gynecomastia in 8 for every 100,000 individuals in our country. This pathology is responsible for 65% of benign pathologies in men.<sup>5</sup>

As to pathophysiology, gynecomastia can arise from an imbalance between the concentrations or the effects of free estrogens

and androgens. Most gynecomastias have an idiopathic cause, roughly 25%, or persistent gynecomastia at puberty, roughly 25%, but there are pathological causes (cirrhosis and malnutrition= 8%, or primary hypogonadism= 8%), less frequently testicular tumors (3%), secondary hypogonadism (2%), hyperthyroidism (1.5%), or kidney disease (1%), medications and drugs (10–20%).

In the treatment of gynecomastia, several available techniques are observed (Figure 1), the choice being based on the degree of pathology, the surgeon's experience, and the adopted tactic.

In the medical field, the treatment of gynecomastia has been little addressed, making it necessary to evaluate the epidemiological and clinical characteristics and the most adopted type of surgery, complications, cosmetic results, and factors related to these results, justifying the present study.

<sup>1</sup>Hospital Barão de Lucena – Recife (PE), Brazil.

<sup>2</sup>Faculdade Pernambucana de Saúde – Recife (PE), Brazil.

\*Corresponding author: darleyferreira63@gmail.com

Conflict of interests: nothing to declare.

Received on: 05/20/2020. Accepted on: 07/16/2020.

## METHODS

This is a prospective and observational study, carried out in the mastology and breast reconstruction service of Hospital Barão de Lucena in 40 patients, between April 2017 and April 2018. Patients were clinically examined at the outpatient clinic, with requests for hormonal tests in some cases, with mammography and ultrasound images in all patients, in which the following variables were analyzed: origin, education level, age, personal history (use of medications), degree of gynecomastia, type of surgery, complications, and cosmetic result.

Patients were assessed using sociodemographic data and background, in addition to factors related to gynecomastia, its treatment and results. A standardized form was used, and data were tabulated in descriptive statistics. For data analysis, a database was built on a Microsoft Excel spreadsheet, which was exported to SPSS software, version 18, in which the analysis was performed. To characterize the personal and clinical profiles, the observed frequencies and percentages of the patients evaluated were calculated, and based on these data, the frequency distribution was constructed. To determine which factors are associated with the cosmetic outcome, the contingency table was constructed and the  $\chi^2$  test for independence was applied. In cases in which the assumptions of the  $\chi^2$  test were violated, Fisher's exact test was applied. All conclusions considered a 5% significance level. Research was approved by the Ethics and Research Committee under number CAAE 63295816.0.0000.5197.

## RESULTS

Table 1 shows the distribution of the personal and clinical profiles of the patients evaluated. Most patients seem to be from the metropolitan region of Recife (72.5%), studied until high school (62.5%), are aged from 10 to 20 (42.5%), have no history (75.0%) for breast cancer, have gynecomastia grade III (47.5%), underwent double incision (52.5%), had no complications (75.0%), and had good or excellent cosmetic outcome (75.0%). The proportion comparison test was significant in all factors evaluated ( $p < 0.05$ ), except for the variable education level ( $p = 0.114$ ).

Table 2 shows the distribution of the cosmetic result according to personal and clinical factors. There is a higher prevalence of regular/poor cosmetic results in the group of patients from outside the metropolitan region of Recife (27.3%), with higher education (33.3%), over 50 years old (50.0%), with personal history (50.0%), with gynecomastia grade III or IV (50.0%), having undergone periareolar surgery (31.2%) and with complications (20.0%). Even though a higher prevalence of regular/bad cosmetics was observed in the group of patients with the profile described, the independence test was significant only in the variable complications ( $p < 0.001$ ), indicating that having complications significantly increases

the risk for regular/bad cosmetic, which is about 26 times higher (prevalence ratio=26) than that of the group of patients without complications.

## DISCUSSION

Gynecomastia is a benign disorder, due to a proliferation of ductal tissues, stroma and fat.<sup>6,7</sup> However, cosmetic changes and physical discomfort in patients cause serious stress and psychological problems, especially in adolescent boys, who avoid taking their shirts off in public places. In our casuistry, most patients were

**Table 1.** Distribution of clinical and surgical profiles of the studied population (n=40).

Factor evaluated	n	%	p-value*
Place of origin			
MR of Recife	29	72.5	0.004
Outside the MR of Recife	11	27.5	
Education level			
Until high school	25	62.5	0.114
Undergraduate	15	37.5	
Age range (years old)			
10 to 20	17	42.5	<0.001
21 to 30	9	22.5	
31 to 40	5	12.5	
41 to 50	1	2.5	
51 to 60	5	12.5	
Over 60	3	7.5	
Medical personal history			
No history	30	75.0	<0.001
Drugs / alcoholism	4	10.0	
Medications	6	15.0	
Degree of gynecomastia			
Degree I	10	25.0	0.001
Degree II	10	25.0	
Degree III	19	47.5	
Degree IV	1	2.5	
Type of surgery			
Periareolar	16	40.0	<0.001
Double incision	21	52.5	
Pitanguy	2	5.0	
Subcutaneous mastectomy	1	2.5	
Complications			
None	30	75.0	<0.001
Seroma	5	12.5	
Bruise	4	10.0	
Keloid	1	2.5	
Cosmetic			
Great	14	35.0	0.004
Good	16	40.0	
Regular	9	22.5	
Bad	1	2.5	

\*p-value of the  $\chi^2$  test for comparison of ratios; MR: metropolitan region.

at puberty (43%). These results are in accordance with the world literature, which shows, the occurrence of 30 to 60% of gynecomastias in this age group. If the patient has pain or hypersensitivity or feels embarrassed by gynecomastia, the possibility of removing the mammary gland should be suggested.<sup>8,9</sup>

Gynecomastia is a very frequent alteration, which justifies the wide range of publications regarding its treatment. There are many causes of gynecomastia, including an imbalance between estrogens and androgens, although its exact etiology is unknown.<sup>10</sup>

Modern surgical treatment begins with the concern to hide the scar as much as possible, by incisions through the areola or very close to it.<sup>11</sup> The periareolar incision has an excellent access route for Simon's small type I and II gynecomastias, with discrete scars, but it promotes a small operative field and, if indicated for larger gynecomastias, it may cause technical difficulties and areolopapillary suffering due to excessive tension<sup>12-14</sup> (Figure 1). For the transareolo-nipple incision or Pitanguy technique, the same considerations are valid (Figure 1).

The R. Sinder zeta incision allows wider access but is still deficient for major gynecomastias. Stewart's submammary incision and/or female glandular resection techniques leave final horizontal and transverse scars, in addition to the periareolar incision, which offers the possibility of proceeding with gland and skin resection in moderate and large hypertrophies, but they are complicated techniques and leave very visible scars (Figure 1).

The double incision periareolar technique (round-block) has been used in our service at Hospital Barão de Lucena for the treatment of grades III and IV gynecomastias. In our material, grades III and IV corresponded to 50% of the cases, and double incision was performed in 52% of the patients, unlike what was found in Montiel et al., which had 50% of the periareolar incisions, because it provides simplicity, insofar as surgeons are familiar with this type of approach in female mammoplasty; safety, by maintaining a wide upper pedicle for the nipple-areolar complex; maintenance and/or correction of the positioning of the nipple-areola complex; symmetry of the nipple-areola complexes, when removing the excess skin in a circular manner; enlargement of the operative field, facilitating and reducing the time of the surgical act and the resection of the excess skin in the surgery with approach in the double incision technique (Figures 2, 3 and 4).

Just like with female mammoplasties, the circular periareolar technique represents an alternative access route in the surgical treatment of large gynecomastias, grades II, III and IV, in which, in addition to excision of the gland, excess skin resection is required. According to Rohrich et al., its classification is based on grades I to IV, in which the volume and degree of ptosis are evaluated.<sup>15</sup>

Scars widening is a frequent complication. It does not occur due to tension, but to extensive skin resection, as well as the

**Table 2.** Distribution of the cosmetic aspect according to personal and clinical factors.

Factor evaluated	Cosmetic		p-value	PR	95%CI
	Regular/Bad (%)	Great/Good (%)			
Place of origin					
MR of Recife	7 (24.1)	22 (75.9)	1.000*	1.00	-
Outside the MR of Recife	3 (27.3)	8 (72.7)		1.13	0.35–3.61
Education level					
Until high school	5 (20.0)	20 (80.0)	0.457*	1.00	-
Undergraduate	5 (33.3)	10 (66.7)		1.67	0.58–4.82
Age range (years old)					
Until 30	5 (19.2)	21 (80.8)	0.236*	1.15	0.16–8.15
31 to 50	1 (16.7)	5 (83.3)		1.00	-
Over 50	4 (50.0)	4 (50.0)		3.00	0.44–20.44
Personal history with medicines or drugs					
Absent	5 (16.7)	25 (83.3)	0.085*	1.00	-
Present	5 (50.0)	5 (50.0)		3.00	1.09–8.25
Degree of gynecomastia					
Degrees I and II	4 (20.0)	16 (80.0)	0.465**	1.00	-
Degrees III and IV	6 (30.0)	14 (70.0)		1.50	0.50–4.52
Type of surgery					
Periareolar	5 (31.2)	11 (68.8)	0.482*	1.50	0.52–4.36
Another	5 (20.8)	19 (79.2)		1.00	-
Complications					
Absent	1 (3.3)	29 (96.7)	< 0.001*	1.00	-
Present	9 (90.0)	1 (10.0)		27.00	3.89–187.53

PR: prevalence ratio; CI: confidence interval for PR; \*p-value of Fisher's exact test; \*\*p-value of the  $\chi^2$  test for independence; MR: metropolitan region.



formation of hematoma and seroma represented 20% of our complications in the post-surgical period. Lapid et al. demonstrated in their casuistry of 20 years of experience that hematoma followed by seroma are the most common complications.<sup>16</sup>

The independence test was significant only in the postoperative complications variable ( $p < 0.001$ ), indicating that these complicating patients significantly increased the risk for unsatisfactory cosmetic results. Most of our patients had a degree

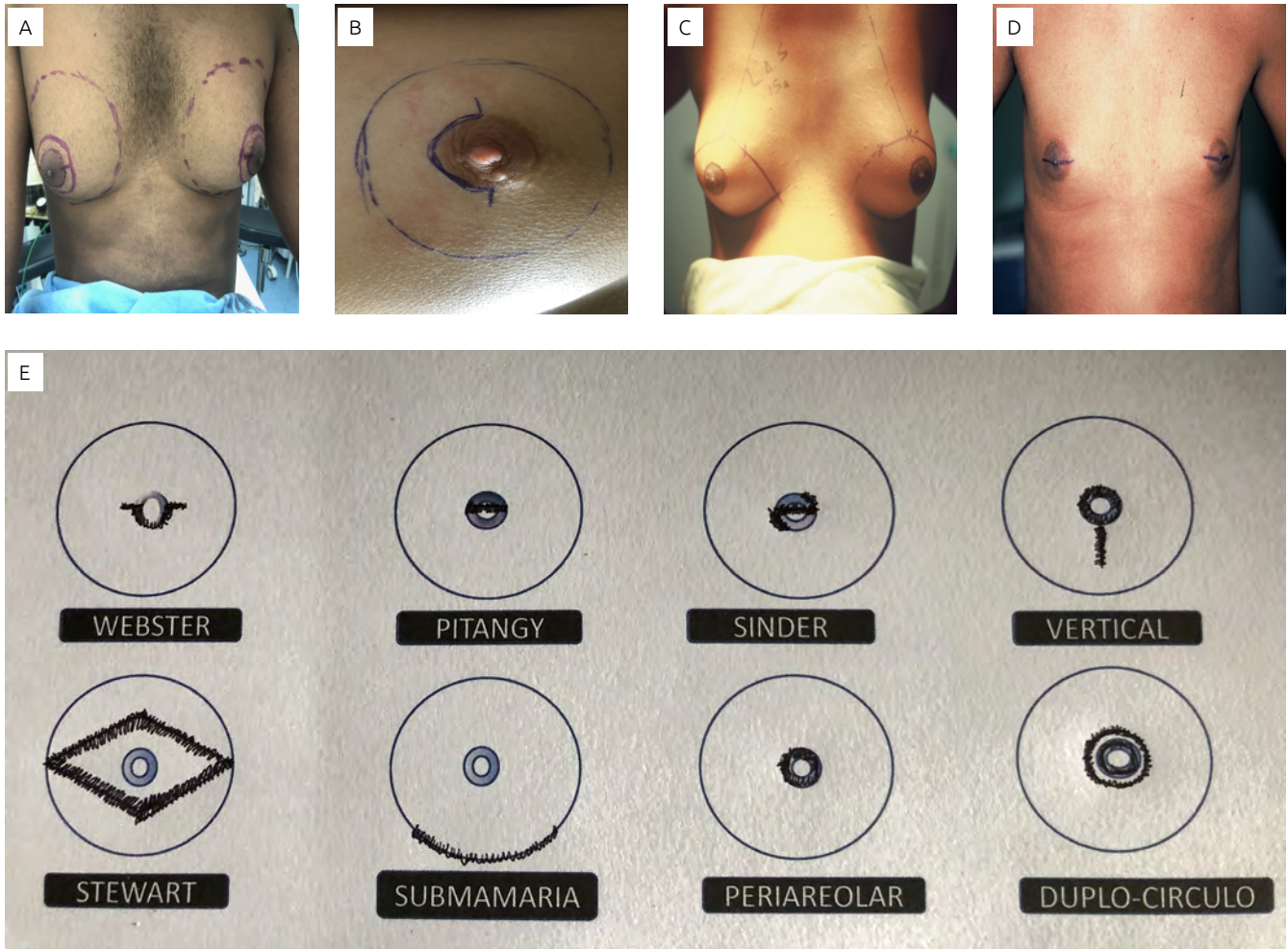

**Figure 1.** Some incisions that can be used in the correction of gynecomastia (double incision [round-block], Webster, periareolar, mastoplasty using the Pitangy technique, transareolopapillary, Sinder, vertical, and Stewart).

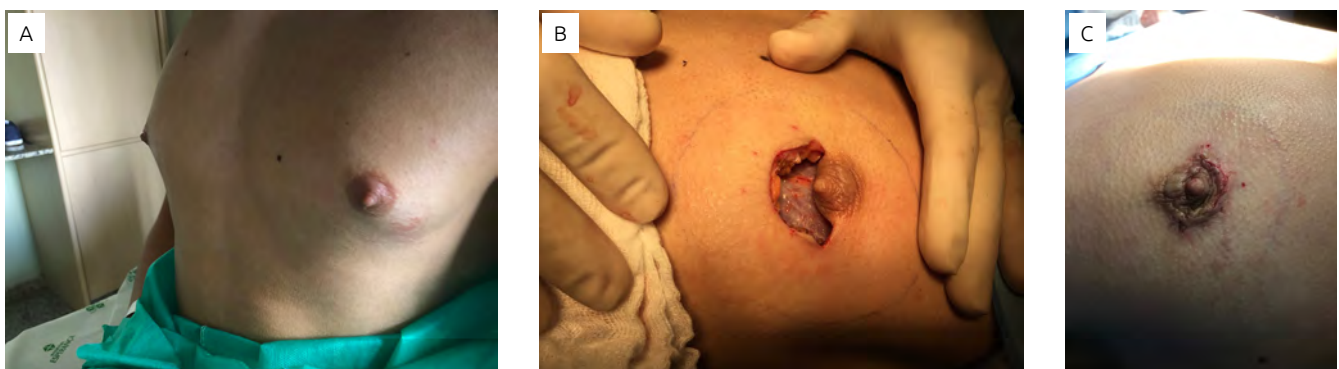

**Figure 2.** Degree I gynecomastia. Pre and postoperative (Webster's periareolar technique).

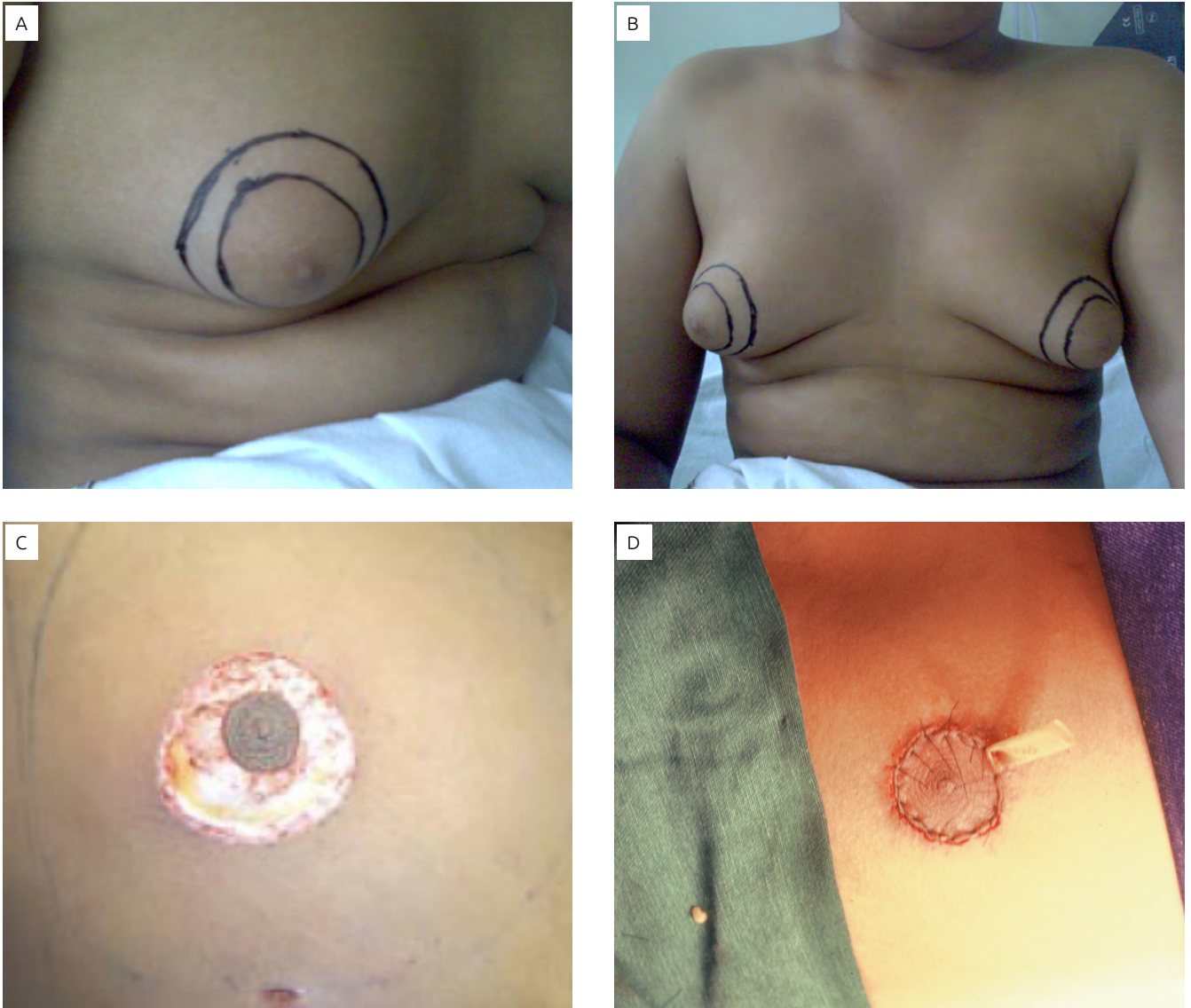

**Figure 3.** Degree II/III gynecomastia. Pre and postoperative (double incision).

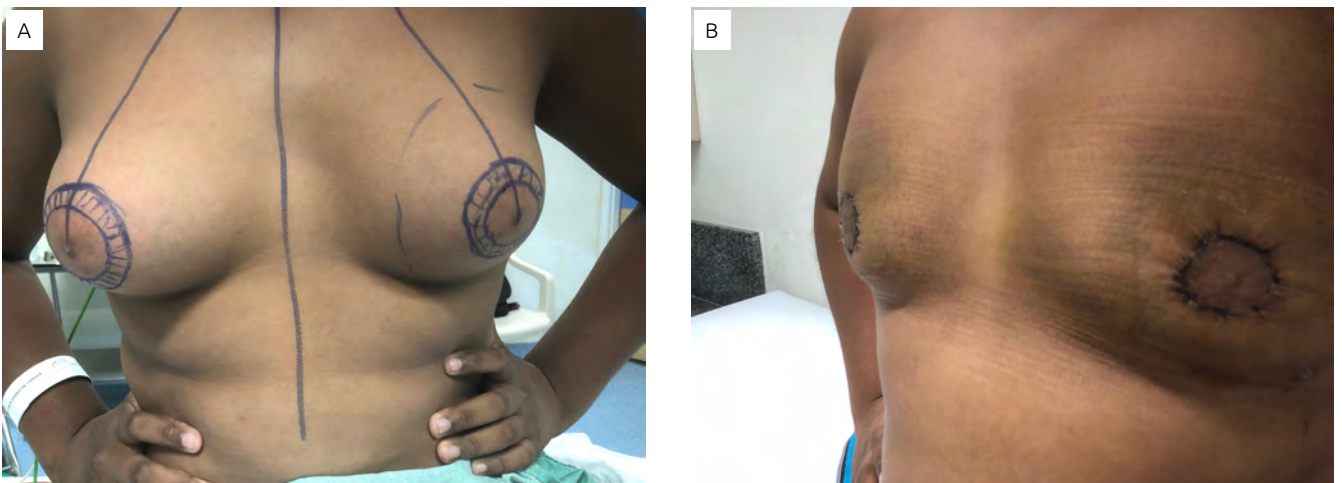

**Figure 4.** Degree III/IV gynecomastia. Pre and postoperative (double incision).

of gynecomastia III/IV (around 50%), with a higher probability of complications. In our casuistry, the degree of satisfaction was 75%. Unlike our results, Gabra et al., in a study with 39 adolescents, found a satisfactory result in 88% of patients, only 12% reported dissatisfaction.<sup>17</sup> Colombo-Benkman et al. also observed, in their analysis of 100 patients, that the degree of gynecomastia II and III and the type of incision are associated with specific sequelae. The degree of patient satisfaction was 86%.<sup>18</sup>

None of our patients underwent treatment with medication to reduce breast volume, given that the Unified Health System (SUS) only releases this type of medication for cancer patients. Besides that, our patients had a large breast volume. Testosterone was used only in hypogonadism. Dihydrotestosterone was effective in some uncontrolled studies. Danazol can bring some benefit, but it has a high cost. Tamoxifen was effective in several studies, at a dose of 20 mg/day for three months, similar to raloxifene. Regarding aromatase inhibitors, there are few studies, although they have shown a positive response with anastrozole 1 mg.<sup>18-22</sup>

## CONCLUSION

Gynecomastia is a pathology that causes great psychosocial impact, and its surgical treatment can bring satisfaction and better adaptation of young patients to society. Patients who do not have postoperative complications are those who have the highest degree of satisfaction.

## AUTHORS' CONTRIBUTION

D.F.: conceptualization, funding acquisition, investigation, methodology, investigation, project administration, supervision, validation, visualization, writing — review & editing.

N.F.: investigation, validation, visualization, writing — review & editing.

N.F.: data curation, formal analysis, investigation, writing — original draft.

T.F.: data curation, formal analysis, investigation, writing — original draft.

D.F.: conceptualization, data curation, formal analysis, investigation, visualization, writing — original draft, writing — review & editing.

## REFERENCES

1. Montiel-Jarquín AJ, Romero-Figueiroa MS, Etchegaray-Morales I, Solís-Mendonza HA. Treatment for gynecomastia: differences for external and inferior periareolar incision for subdermal mastectomy. *Rev Chil Cir.* 2017;69(1):10-5. <http://dx.doi.org/10.4067/S0718-40262017000100005>
2. Narula HS, Carlson HE. Gynecomastia: pathophysiology, diagnosis and treatment. *Nt Rev Endocrinol.* 2014;10(11):684-98. <https://doi.org/10.1038/nrendo.2014.139>
3. Montana Padilla, GS, Eugenio Camargo G, Sánchez Capacho N, Diaz Matallana M, Reyes Mendoza JG. Knowledge and practices of gynecomastia of non-specialist's doctors. *Rev Investig Solid Univ Boyacá.* 2019;6(1):34-54. <https://doi.org/10.24267/23897325.283>
4. Leung AKC, Leung AAC. Gynecomastia in infants, children, and adolescents. *Recent Pat Endocr Metab Immune Drug Discov.* 2016;10(2):127-37. <https://doi.org/10.2174/1872214811666170301124033>
5. Medeiros MM. Abordagem cirúrgica para tratamento de gynecomastia conforme sua classificação. *Rev Bras Cir Plást.* 2012;27(2):277-82. <https://doi.org/10.1590/S1983-51752012000200018>
6. Wilson JD, Aiman J, MacDonald PC. The pathogenesis of gynecomastia. *Adv Intern Med.* 1980;29:1-32.
7. Braunstein GD. Gynecomastia. *N Engl J Med.* 1993;328:490-5. <https://doi.org/10.1056/NEJM199302183280708>
8. Lapid O, Jolink F. Surgical management of gynecomastia: 20 years experience. *Scand J Surg.* 2014;103(1):41-5. <https://doi.org/10.1177/1457496913496359>
9. Ma NS, Geffner ME. Gynecomastia in prepuberal and pubertal men. *Curr Opin Ped.* 2008;20(4):465-70. <https://doi.org/10.1097/MOP.0b013e328305e415>
10. Karp NS. Gynecomastia. In: Thorne CH, Beasley RW, Aston SJ, Gurtner GC, Spear SL, editors. *Grabb and Smith's Plastic Surgery.* 6. ed. Filadélfia: Wolters Kluwer Lippincott Williams & Wilkins; 2006. p. 616-20.
11. Hammond DC. Surgical correction of gynecomastia. *Plast Reconstr Surg.* 2009;124(1 Supl.):61e-8e. <https://doi.org/10.1097/prs.0b013e3181aa2dc7>
12. Waltho D, Hatchell A, Thoma A. Gynecomastia classification for surgical management: A Systematic Review and Novel Classification System. *Plast Reconstr Surg.* 2017;139(3):638e-48e. <https://doi.org/10.1097/prs.0000000000003059>
13. Webster JP. Mastectomy for Gynecomastia through semicircular intra-areolar incisions. *Ann Surg.* 1946;124(3):557-75.
14. Simon BE, Hoffman S, Kahn S. Classification and surgical correction of Gynecomastia. *Plast Reconstr Surg.* 1973;51(1):48-52.
15. Rohrich RJ, Ha RY, Kenkel JM, Adams Jr. WP. Classification and Management of Gynecomastia: defining the role of ultrasound-assisted liposuction. *Plast Reconstr Surg.* 2003;111(2):909-23. <https://doi.org/10.1097/01.prs.0000042146.40379.25>
16. Gruntmanis U, Braunstein GD. Treatment of Gynecomastia. *Curr Opin Invest Drug.* 2001;2(5):643-9.
17. Gabra HO, Morabito A, Bianchi A, Bowen J. Gynecomastia in the adolescent: A Surgically Relevant Condition. *Eur J Pediatr Surg Feb.* 2004;14(1):3-6. <https://doi.org/10.1055/s-2004-815772>

18. Colombo-Benkmann M, Buse B, Stern J, Herfarth C. Indications for and results of surgical therapy for male gynecomastia. *Am J Surg.* 1999;178(1):60-3. [https://doi.org/10.1016/s0002-9610\(99\)00108-7](https://doi.org/10.1016/s0002-9610(99)00108-7)
19. Lawrence SE, Faught KA, Vethamuthu J, Lawson ML. Beneficial effects of raloxifene and tamoxifen in the treatment of pubertal gynecomastia. *J Pediatr.* 2004;145(1):71-6. <https://doi.org/10.1016/j.jpeds.2004.03.057>
20. Hanavadi S, Banerjee D, Monypenny IJ, Mansel RE. The role of tamoxifen in the management of gynecomastia. *Breast.* 2006;15(2):276-80. <https://doi.org/10.1016/j.breast.2005.04.007>
21. Zachmann M, Eiholzer U, Muritano M, Werder EA, Manella B. Treatment of pubertal gynaecomastia with testolactone. *Acta Endocrinol Suppl (Copenh).* 1986;279:218-26. <https://doi.org/10.1530/acta.0.112s218>
22. Plourde PV, Reiter EO, Jou HC, Desrochers PE, Rubin SD, Bercu BB, et al. Safety and efficacy of anastrozole for the treatment of pubertal gynecomastia: a randomized, double-blind, placebo-controlled trial. *J Clin Endocrinol Metab.* 2004;89(9):4428-33. <https://doi.org/10.1210/jc.2004-0082>



# Publication rate of abstracts on breast cancer presented at different scientific events in Brazil

Rosemar Macedo Sousa Rahal<sup>1,2\*</sup> , Sergio Nascimento<sup>1</sup> , Leonardo Ribeiro Soares<sup>2</sup> , Ruffo Freitas-Junior<sup>1,2</sup> 

## ABSTRACT

**Introduction:** Medical congresses allow scientific production to be appropriately disseminated and discussed. However, most of the scientific papers presented at medical congresses do not go on to be published in indexed journals. The present study aimed to characterize the abstracts presented at three different congresses on breast cancer held in Brazil, and to determine the publication rate of these three events. **Methods:** Observational, retrospective study, where the observation unit consisted of the scientific papers presented at the Brazilian Congress of Mastology (CBM), Jornada Paulista de Mastologia (JPM) and Brazilian Breast Cancer Symposium (BBCS) in 2017. Initially, we recorded all the abstracts of works presented at the event. Subsequently, the works were searched in digital databases (BIREME/LILACS and MEDLINE/PubMed) and in the respective resumes of the authors on the Lattes platform. **Results:** The study included 266 abstracts of scientific papers presented in the three selected events, of which 21 (7.9%) were published in an indexed journal. Most of these studies were conducted predominantly in public institutions (71.1%), located in the State of São Paulo (30.5%) and were presented in the form of a poster (77.8%). The publication rate from the BBCS, CBM and JPM was 13.4, 5.4 and 3.4%, respectively ( $p = 0.03$ ). Considering the published articles, there was no difference in journal impact factor between the congresses ( $p = 0.49$ ). "Mastology" was the journal that received the largest number of publications ( $n = 8$ ; 38.1%). **Conclusion:** In 2017, less than 10% of the abstracts on breast cancer presented at Brazilian congresses were published in an indexed journal. Among the main specialty events in the country, the Brazilian Breast Cancer Symposium has a significantly higher publication rate.

**KEYWORDS:** breast neoplasms; bibliometrics; research report; journal article.

## INTRODUCTION

The dissemination of knowledge obtained through scientific research is a primary step in the evolution process of health care<sup>1,2</sup>. Accordingly, congresses and scientific events are the opportune place for the presentation and discussion of new knowledge, where the authors of each study can present their results and the practical implications of the research, among other benefits. In addition, medical congresses allow continuing education, the discussion of clinical cases and interpersonal contact between different geographic regions<sup>3,4</sup>.

After the production of knowledge and the presentation of results at scientific events, it is essential that this content be

published in some safe and reliable source of accessible information. This publication allows the globalization of knowledge and external validation of results, and it has different implications for clinical practice<sup>1,2</sup>. Nevertheless, it must occur in indexed journals, with an experienced editorial board and rigorous peer review<sup>2,5</sup>.

In recent years, despite the expansion of scientific production worldwide, it is observed that most scientific papers presented in medical congresses are not published later in indexed journals<sup>6,7</sup>. In Brazil, most bibliometric studies indicate a publication rate between 5 and 20% of the research presented at medical congresses<sup>6,7</sup>. At the University of São Paulo, one of the most prestigious universities in Latin America, less

<sup>1</sup>Faculdade de Medicina, Universidade Federal de Goiás – Goiânia (GO), Brasil.

<sup>2</sup>Centro Avançado de Diagnóstico da Mama, Hospital das Clínicas, Universidade Federal de Goiás – Goiânia (GO), Brasil.

\*Corresponding author: [rosems@terra.com.br](mailto:rosems@terra.com.br)

Conflict of interests: nothing to declare.

Received on: 07/23/2020. Accepted on: 08/24/2020.

than 50% of the doctoral theses presented between 1990 and 2000 were published within five years<sup>8</sup>. Together, these data raise questions about the model of scientific production in Brazil and reinforce the hypothesis that the rate of publication of papers presented at mastology congresses is modest.

In Brazil, the first bibliometric evaluation studies related to mastology were recently published, but they are limited to scientific production in oncoplastic surgery and breast repair surgery<sup>9,10</sup>. However, to our knowledge, no study has been carried out to assess the scientific production presented at the mastology congresses held in the country and the articles resulting from these presentations.

Our aim was to characterize the studies presented at three different mastology congresses held in Brazil, and to evaluate the publication rate of these events.

## METHODS

This was an observational, retrospective study, where the observation unit consisted of the scientific papers presented at three different events in mastology: Brazilian Congress of Mastology (CBM), Jornada Paulista de Mastologia (JPM) and Brazilian Breast Cancer Symposium (BBCS). The first two prioritize continuing education and have a parallel agenda dedicated to scientific work<sup>11</sup>. BBCS is directed at scientific research and offers several facilities for speakers and high prizes for the best papers presented<sup>12</sup>. The events were selected for their importance in the context of mastology in Brazil. The year 2017 was selected taking into account an opportune period of two years for the publication of free themes presented in the respective congresses.<sup>13</sup>

## Variables

Initially, all works presented at the aforementioned congresses were selected in the respective abstract books and included in a specific database, with the aid of the Microsoft Excel program (Microsoft, USA), version 2013. The following information was collected: title of the abstract, authors, institution and state where the study was conducted. The free themes were classified according to the type of presentation: poster, oral presentation and, when relevant, comment poster.

The main theme of the study was classified as “epidemiology”, “breast cancer diagnosis”, “breast cancer treatment”, “breast cancer rehabilitation”, “benign pathologies”, “in situ carcinoma”, “experimental studies” and “miscellaneous themes”. The category “diverse themes” included studies not classified in the others, such as “breast cancer during pregnancy” and “access to health services”, among others. The places where the studies were carried out were classified as “public services”, “private services” or “mixed”.

To assess the possible publication, the works were initially sought in the description of the personal curriculum vitae available on the Lattes Platform ([www.lattes.cnpq.br](http://www.lattes.cnpq.br)), of the National Council for Scientific and Technological Development (CNPq). The search was carried out independently by two researchers, using the names of the authors of each abstracted presented at the congress.

Subsequently, the studies were searched in the online databases Latin American and Caribbean Health Sciences Information (BIREME)/Latin American and Caribbean Literature in Health Sciences (LILACS) - Virtual Health Library (<http://lilacs.bvsalud.org/>); and PubMed - US National Library of Medicine, National Institutes of Health (<https://www.ncbi.nlm.nih.gov/pubmed>). Finally, when the search was negative for the authors' names, an additional search was performed through the title of the work, in the same databases.

For studies that were published in journals, agreement with the work previously presented at the medical congress was evaluated. Changes in titles, authors, objectives, materials and methods, results and conclusions were examined.

The absolute number of publications, the year and publication journal (national or international), type of study and quality of scientific evidence were analyzed. The journals were classified according to the Qualis classification of journals of the Coordination for the Improvement of Higher Education Personnel (CAPES), for the 4-year period 2013–2016<sup>14</sup>. The score in the Medicine II category was considered through the standardization of the Postgraduate Program in Health Sciences at the Federal University of Goiás. The publication rate for each congress was obtained from the proportion of works presented that were published.

To classify the degree of scientific evidence, the classification validated by the Brazilian Medical Association was used: (a): experimental or observational studies of better consistency (meta-analyses or randomized clinical trials); (b): less consistent experimental or observational studies (other non-randomized clinical trials or observational studies or case-control studies); (c): reports or case series (uncontrolled studies); (D): opinion without critical evaluation, based on consensus, physiological studies or animal models.<sup>15</sup>

## Statistical analysis

The collected data were initially entered in a spreadsheet using the Microsoft Office Excel program version 2013, (Microsoft Corporation, Redmond, CA, USA), and later analyzed with the aid of the statistical program Statistical Package for the Social Sciences (SPSS) version 26.0 (IBM Corporation, Armonk, NY, USA). The data were characterized by means of absolute frequency (n) and relative frequency (%). In this study, non-parametric statistical tests and techniques were applied, as verified through the Kolmogorov-Smirnov normality test. The comparison of the

dynamics of scientific production between the groups was performed using Pearson's  $\chi^2$  test followed by *post hoc* analysis<sup>16</sup>. Among the articles published from each congress, the comparison of the journal's impact factor was made done using the Kruskal-Wallis test. In all analyses, the level of significance was 5% ( $p < 0.05$ ).

### Ethics aspects

According to what was established in the Resolution of the National Health Council (CNS) No. 466, of December 12, 2012, it was not necessary to submit this study to the National Research Ethics Commission (CEP/CONEP), as it involved free data with unrestricted access<sup>17</sup>. The information obtained was extracted from secondary banks, in the public domain. Thus, an informed consent term was not needed, nor was there any identification of the research subjects.

## RESULTS

The study included 266 abstracts of scientific studies presented at the three selected events in 2017. Most of them were conducted predominantly in public institutions (71.1%) and presented in the form of a poster (77.8%). The prevalent themes were breast surgery (19.2%) and histological aspects (19.5%) (Table 1).

**Table 1.** Characterization of institution of origin, type of presentation and theme of the works presented at three mastology congresses in Brazil, in 2017 (n = 266).

	N	%
Congress		
BBCS	97	36.5
CBM	111	41.7
JPM	58	21.8
Type of institution		
Mixed	22	8.3
Private	55	20.7
Public	189	71.1
FU of institution		
DF	8	3.0
GO	58	21.8
MG	12	4.5
PE	29	10.9
RN	7	2.6
RS	18	6.8

Continue...

**Table 1.** Continuation.

	N	%
SP	81	30.5
Others	53	19.9
Type of presentation		
Oral presentation	19	7.1
Poster	207	77.8
Comment poster	40	15.1
Theme		
Basic sciences	19	7.1
Surgery	51	19.2
Epidemiology	31	11.7
Histology	52	19.5
Radiology	17	6.4
Radiotherapy	4	1.5
Rehabilitation	11	4.1
Systemic treatment	13	4.9
Others	68	25.6
Publication		
No	245	92.1
Yes	21	7.9
Quality of journal		
A1	1	4.8
A2	3	14.3
B1	6	28.6
B2	2	9.5
B4	1	4.8
B5	8	38.1
Year of publication		
2017	4	19.0
2018	9	42.9
2019	8	38.1
Concordance		
Partial	13	61.9
Total	8	38.1
Degree of recommendation		
B	15	71.4
C	1	4.8
D	5	23.8

n: absolute frequency; %: relative frequency; BBCS: Brazilian Breast Cancer Symposium; CBM: Brazilian Congress of Mastology; JPM: Jornada Paulista de Mastologia; FU: federation unit

Considering the origin of the works presented, there was a predominance of studies conducted in the same state in which the event was held (Table 2).

Among all the abstracts presented, 21 (7.9%) were published in an indexed journal. All articles were published in English and most of these publications occurred in journals classified

**Table 2.** Comparison of institution of origin, type of presentation and theme of works between the three congresses analyzed (n = 266).

	Congress, n (%)			p*
	BBCS	CBM	JPM	
<b>Type of institution</b>				
Mixed	9 (9.3)	10 (9.0)	3 (5.2)	<b>0.01</b>
Private	13 (13.4)	25 (22.5)	17 (29.3)†	
Public	75 (77.3)	76 (68.5)	38 (65.5)	
<b>FU of institution</b>				
DF	7 (7.2)†	0 (0.0)	1 (1.7)	<b>&lt; 0.001</b>
GO	54 (55.7)†	4 (3.6)	0 (0.0)	
MG	2 (2.1)	8 (7.2)	2 (3.4)	
PE	3 (3.1)	26 (23.4)†	0 (0.0)	
RN	0 (0.0)	4 (3.6)	3 (5.2)	
RS	2 (2.1)	12 (10.8)	4 (6.9)	
SP	14 (14.4)	24 (21.6)	43 (74.1)†	
Others	15 (15.5)	33 (29.7)†	5 (8.6)	
<b>Type of presentation</b>				
Oral presentation	15 (15.5)	10 (9.0)	4 (6.9)	<b>0.06</b>
Poster	67 (69.1)	76 (68.5)	54 (93.1)	
Comment poster	15 (15.5)	25 (22.5)	0 (0.0)	
<b>Theme</b>				
Basic sciences	16 (16.5)†	3 (2.7)	0 (0.0)	<b>0.005</b>
Surgery	11 (11.3)	28 (25.2)†	12 (20.7)	
Epidemiology	14 (14.4)	12 (10.8)	5 (8.6)	
Histology	18 (18.6)	23 (20.7)	11 (19.0)	
Radiology	5 (5.2)	6 (5.4)	6 (10.3)	
Radiotherapy	2 (2.1)	1 (0.9)	1 (1.7)	
Rehabilitation	4 (4.1)	7 (6.3)	0 (0.0)	
Systemic treatment	5 (5.2)	4 (3.6)	4 (6.9)	
Others	22 (22.7)	27 (24.3)	19 (32.8)	
<b>Publication</b>				
No	84 (86.6)	105 (94.6)	56 (96.6)	<b>0.03</b>
Yes	13 (13.4)†	6 (5.4)	2 (3.4)	

\*Pearson  $\chi^2$  test; † $\chi^2$  post hoc test; n: absolute frequency; %: relative frequency; BBCS: Brazilian Breast Cancer Symposium; CBM: Brazilian Congress of Mastology; JPM: Jornada Paulista de Mastologia; FU: federation unit.

as Qualis B5 (n = 8; 38.1%). Considering the agreement between the abstract presented at the congress and the abstract of the published article, it was observed that 13 (61.9%) showed some modification (Table 1).

In 2017, the publication rate for the BBCS, CBM and JPM was 13.4, 5.4 and 3.4%, respectively (p = 0.03). In the comparison between congresses, there was a higher rate of studies from private institutions at JPM, and surgical studies at CBM (Table 2). Table 3 shows the profile of the articles published from each selected congress.

Considering the published articles, there was no difference in journal impact factor between the congresses at which the work was initially presented (p = 0.49; Figure 1). Table 4 shows the nominal distribution of journals in which the works were published, with no difference between congresses (p = 0.54). Nominally, the journal Mastology, organized by the Brazilian Society of Mastology (SBM), was the journal that received the largest number of publications (n = 8; 38.1%; Figure 2). Analyzing the frequency of publications between the groups according to the type of institution, it was observed that the papers published from the BBCS and CBM were mainly from public institutions (Table 5).

**Table 3.** Comparison of articles published from three mastology congresses that took place in Brazil in 2017 (n = 21).

	Congress, n (%)			P
	BBCS	CBM	JPM	
<b>Type of journal</b>				
A1	1 (7.7)	0 (0.0)	0 (0.0)	<b>0.98</b>
A2	2 (15.4)	1 (16.7)	0 (0.0)	
B1	3 (23.1)	2 (33.3)	1 (50.0)	
B2	1 (7.7)	1 (16.7)	0 (0.0)	
B4	1 (7.7)	0 (0.0)	0 (0.0)	
B5	5 (38.5)	2 (33.3)	1 (50.0)	
<b>Year of publication</b>				
2017	3 (23.1)	1 (16.7)	0 (0.0)	<b>0.88</b>
2018	6 (46.2)	2 (33.3)	1 (50.0)	
2029	4 (30.8)	3 (50.0)	1 (50.0)	
<b>Concordance</b>				
Partial	9 (69.2)	4 (66.7)	0 (0.0)	<b>0.16</b>
Total	4 (30.8)	2 (33.3)	2 (100.0)	
<b>Degree of recommendation</b>				
B	9 (69.2)	5 (83.3)	1 (50.0)	<b>0.03</b>
C	0 (0.0)	0 (0.0)	1 (50.0)†	
D	4 (30.8)	1 (16.7)	0 (0.0)	

\*Pearson  $\chi^2$  test; † $\chi^2$  post hoc test; n: absolute frequency; %: relative frequency; BBCS: Brazilian Breast Cancer Symposium; CBM: Brazilian Congress of Mastology; JPM: Jornada Paulista de Mastologia.



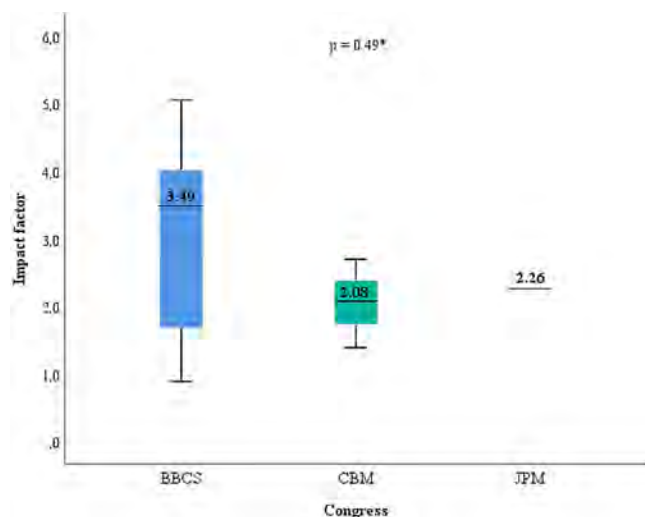

\*Kruskal-Wallis test (comparison between two medians, because only one article from the Jornada Paulista de Mastologia (JPM) was published in a journal with an available impact factor); BBCS: Brazilian Breast Cancer Symposium; CBM: Brazilian Congress of Mastology.

**Figure 1.** Boxplot comparing the impact factor of the journals between groups (n = 21).

**Table 4.** Comparison of journal in which the article was published between the groups (n = 21).

Journal	Congress, n (%)			p*
	BBCS	CBM	JPM	
Aesthetic Plastic Surgery	0 (0.0)	1 (16.7)	0 (0.0)	0.54
Biointerface Research in Applied Chemistry	1 (7.7)	0 (0.0)	0 (0.0)	
Breast (Edinburgh)	1 (7.7)	0 (0.0)	0 (0.0)	
Breast Care	0 (0.0)	1 (16.7)	0 (0.0)	
Climacteric	0 (0.0)	0 (0.0)	1 (50.0)	
Clinical Breast Cancer	0 (0.0)	1 (16.7)	0 (0.0)	
Food Research International	1 (7.7)	0 (0.0)	0 (0.0)	
International Journal of Nanomedicine	1 (7.7)	0 (0.0)	0 (0.0)	
Journal of Biomedical Nanotechnology	1 (7.7)	0 (0.0)	0 (0.0)	
Journal of Radiological Protection	1 (7.7)	0 (0.0)	0 (0.0)	
Mastology	5 (38.5)	2 (33.3)	1 (50.0)	
MicroRNA	0 (0.0)	1 (16.7)	0 (0.0)	
The Breast	2 (15.4)	0 (0.0)	0 (0.0)	

\*Pearson  $\chi^2$  test; n: absolute frequency; %: relative frequency; BBCS: Brazilian Breast Cancer Symposium; CBM: Brazilian Congress of Mastology; JPM: Jornada Paulista de Mastologia.

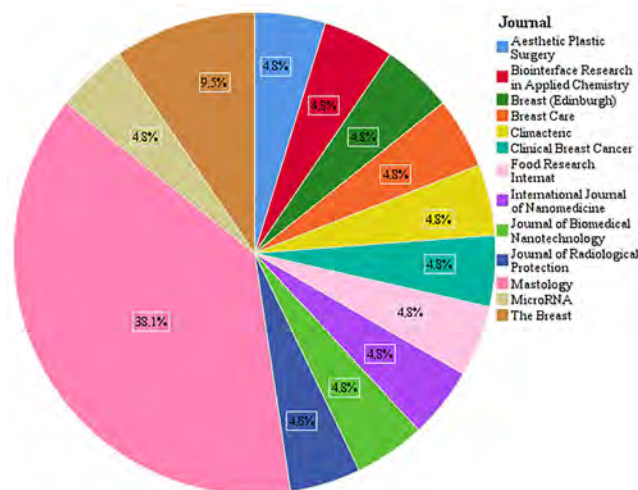

**Figure 2.** Pie chart describing the journals in which the articles were published (n = 21).

**Table 5.** Comparison of frequency of publications between groups according to type of institution.

Type of institution	Congress, n (%)			p*
	BBCS	CBM	JPM	
Mixed	0 (0.0)	0 (0.0)	1 (33.3)†	<b>0.03</b>
Private	1 (7.7)	0 (0.0)	0 (0.0)	0.11
Public	12 (16.0)†	6 (7.9)	1 (2.6)	<b>0.04</b>

\* Pearson  $\chi^2$  test; † post hoc test; n: absolute frequency; %: relative frequency; BBCS: Brazilian Breast Cancer Symposium; CBM: Brazilian Congress of Mastology; JPM: Jornada Paulista de Mastologia.

## DISCUSSION

In Brazil, the first bibliometric studies related to mastology and breast cancer were published in the last decade, but they are restricted to surgical themes and breast reconstruction<sup>9,10</sup>. In other specialties, the content and publication rate of the main scientific congresses have been monitored over time and are indicators related to the production and dissemination of scientific knowledge<sup>6,7,18</sup>. In this context, the current study reveals the critical situation with publication rate of the main scientific events that address breast cancer in Brazil, in addition to providing an overview of the respective congresses.

The characterization of the works presented at the selected events revealed significant geographical differences in their origin, with a predominance of studies conducted in the state where the event was held. This finding goes against the current aims of universalization and decentralization of scientific knowledge, effected, in part, by holding meetings of this nature outside the Rio de Janeiro-São Paulo axis. In the coming years, greater access

to communication technologies and the advancement of teleconferencing systems may further facilitate the dissemination of scientific knowledge by Brazilian researchers.

The publication rate observed in the three congresses, together, was only 7.9%. This index is in line with that observed in most other specialty congresses conducted in Brazil, which generally varies between 5 and 20%<sup>6,7,18</sup>. In the international context, we did not identify in the literature other studies that analyzed events related to breast cancer, only some specific thematic assessments<sup>19</sup>. However, considering other international congresses on medical specialties, there are publication rates of scientific papers close to 50%, reflecting a major gap in the capacity for scientific dissemination between the two contexts<sup>20,21</sup>.

Among the possible factors related to the low publication rate, the methodological limitations of the research presented in Brazilian scientific events should be highlighted<sup>13,22</sup>. These deficiencies end up being perpetuated in the respective scientific publications, and some reviews indicate that up to 75% of the articles published in certain journals have some flaw in the statistical analysis<sup>23</sup>. In the current study, this could be associated with the predominance of presentations in poster format, which generally correspond to studies with less scientific impact, and the predominance of publications in journals classified as Qualis B5, the lowest category among indexed journals. Although this information did not necessarily mean poor scientific quality, it could indicate methodological limitations that culminated in publications in a journal with a lower impact factor.

Other factors such as financial limitations, lack of institutional incentives and lack of technical support can also discourage the scientific publication of a recently completed study. However, in recent years, public policies to encourage research have culminated in a substantial increase in the number of published articles<sup>4,13,24,25</sup>. This growth trend was also observed in the Brazilian participation in international events and research related to breast cancer<sup>26</sup>. In this context, the expansion of existing incentives and the formulation of new strategies for the dissemination of scientific production should be considered fundamental pillars of government policies for science and technology. Nevertheless, the search for self-sustainable scientific projects and alternative sources of financial and structural resources represent another viable path for Brazilian researchers<sup>26,27</sup>.

Another point to be highlighted are inconsistencies between the presentation at the congress and the respective publication in about 60% of cases<sup>28,29</sup>. This percentage is in line with that observed in other bibliometric studies and can be explained by several factors, such as the consolidation of data initially presented as preliminary results and the textual modifications suggested in the congress itself or by the journal's reviewers. On this issue, a study conducted by the Association of Surgeons of Great Britain and Ireland observed significant changes in the

titles of the papers (8.8%) and in the authors (58.5%), increase or decrease in the sample (56%), methodological changes (21.1%) and different interpretation of results (11.6%)<sup>28</sup>. Thus, the presentation and discussion of free themes at scientific events remain relevant in the process of building and disseminating knowledge.

In Brazil, the evaluation of scientific papers that will be accepted for presentation at a medical congress is the responsibility of the institution that organized the event. Generally, a specific committee is selected for this purpose, formed by professionals with recognized scientific experience. However, the criteria to be used by each professional, or in each congress, can vary and even be subjective. In some situations, duplicate, incomplete, inconclusive and/or serious methodological limitations are observed<sup>30</sup>. In addition, clinical case reports are presented without any relevant discussion or addition to the medical knowledge already available<sup>30,31</sup>. In addition, as the presenter of the free topic also needs to register for the event, there is the fear that the refusal of the submitted papers may reduce the final number of participants. Therefore, the data presented here may indicate the need for improvement and professionalization of this selection process, prioritizing technical and scientific criteria at the detriment of indiscriminate approval of free topics.

The current model of scientific production in Brazil is predominantly linked to graduate programs and financed by the authors themselves or by public institutions that support research<sup>24,25</sup>. Thus, the publication process becomes dependent on financial and motivational factors of the respective students and professors, who often give up publishing their works after rejection by the first journals. Accordingly, the predominance of articles published in the journal *Mastology* is possibly justified by a series of benefits for the publication of national articles<sup>32</sup>. This fact also reflects the relevance of class societies in the academic scenario of Brazil, considering that continuing education, research activities and the dissemination of scientific knowledge are present in the mission, vision and values of SBM<sup>33</sup>.

Among the congresses included in the present analysis, the BBCS organization format should be noted, where its presentation of free themes is included in the main program of the event and offers researchers a major role in the dissemination and discussion of their results<sup>12</sup>. On the other hand, CBM and JPM are congresses predominantly aimed at continuing education, whose presentation of free themes constitutes a secondary and discreet schedule<sup>11</sup>. This characteristic of encouraging researchers at the BBCS likely contributed to obtaining a higher publication rate, which was 2.5 times higher compared to CBM and 3.9 times higher compared to JPM. In addition, considering the impact factor of the journals in which the articles were published, it was observed that the average of the works previously presented at the BBCS was 3.49 compared to 2.08 at the CBM. This difference

was not significant in the statistical analysis, probably due to the sample size, but possibly indicated a trend towards publications with a higher level of evidence.

The current study has limitations inherent to secondary-based investigations, such as retrospective design and limited access to some variables that could add information to the discussion. On the other hand, the standardization of the methodology and the rigor in the search for articles adds robustness to the data found in the present series, which is the first bibliometric survey in mastology in Brazil. The two-year period after the last event included minimizes the temporal bias that could be pointed out in relation to the publication rate, although this rate may, in fact, increase in the coming years. Finally, we suggest the continued evaluation of the publication of these meeting presentations over the next few years, to monitor the evolution of the publication rate of works presented at mastology congresses in Brazil.

## CONCLUSION

In 2017, less than 10% of the papers presented at breast cancer congresses held in Brazil were published in an indexed journal. Among the main specialty events in the country, the BBCS has a significantly higher publication rate.

## AUTHORS' CONTRIBUTIONS

R.M.S.R.: Conceptualization, investigation, methodology, investigation, project administration, supervision, validation, visualization, writing – review & editing.

S.N.: Conceptualization, investigation, validation, visualization, writing – original draft.

L.R.S.: Conceptualization, investigation, data curation, formal analysis, investigation, writing – original draft.

R.F.: Data curation, formal analysis, investigation, writing – review & editing.





## REFERENCES

1. Sarkar B, Wang YX, Cai J. The open access financial model hinders the growth of medical physics research in low- and middle-income countries. *Med Phys*. 2020. <http://doi.org/10.1002/mp.14220>
2. Guimarães J. Medical and biomedical research in Brazil. A comparison of Brazilian and international scientific performance. *Ciênc Saúde Coletiva*. 2004;9(2):307-27. <https://doi.org/10.1590/S1413-81232004000200009>
3. Ejnisman L, Gomes GS, Oliveira RG, Malavolta EA, Gobbi RG, Camargo OP. Publication rates of papers presented at the Brazilian Orthopedic Meeting. *Acta Ortop Bras*. 2013;21(5):285-7. <https://doi.org/10.1590/S1413-78522013000500009>
4. Arap MA, Reis RB, Torricelli FC, Masson AL, Saad ED. Brazilian abstracts presented at the American Urological Association annual meetings: contribution, publication rates, and comparison with oncology abstracts. *Int Braz J Urol*. 2014;40(6):730-7. <https://doi.org/10.1590/S1677-5538.IBJU.2014.06.03>
5. Albuquerque UP. A qualidade das publicações científicas - considerações de um editor de área ao final do mandato. *Acta Bot Bras*. 2009;23(1):292-6. <https://doi.org/10.1590/S0102-33062009000100031>
6. Forlin E, Fedato RA, Altmann-Junior W. Publication of studies presented as free papers at a Brazilian national orthopedics meeting. *Rev Bras Ortop*. 2013;48(3):216-20. <https://doi.org/10.1016/j.rbo.2012.10.005>
7. Yoshida BW, Holmo NF, Corregliano GT, Baldon KM, Souza e Silva N. Publicações indexadas geradas a partir de resumos de congressos de angiologia e cirurgia vascular no Brasil. *J Vasc Bras*. 2008;7(4):293-7. <https://doi.org/10.1590/S1677-54492008000400002>
8. Younes RN, Deheinzeln D, Birolini D. Graduate education at the faculty of medicine of the University of Sao Paulo: quo vadis? *Clinics*. 2005;60(1):6-8. <http://doi.org/10.1590/S1807-59322005000100003>
9. Pires DM, Mendonça ACG, Valadares CN, Barbosa GEF, Silva VB, Nunes AMS. Scientific publications of Brazilian mastologists regarding oncoplastic and reconstructive breast surgery: a bibliometric study. *Mastology*. 2017;27(2):124-30. <http://doi.org/10.5327/Z2594539420170000177>
10. Freitas-Junior R, Faria SS, Paulinelli RR, Ferreira NC. Bibliometrics trends in oncoplastic surgery and breast reconstruction from 1980 to 2016. *Eur J Cancer*. 2018;92(Suppl. 3):S87. [http://doi.org/10.1016/S0959-8049\(18\)30488-X](http://doi.org/10.1016/S0959-8049(18)30488-X)
11. Jornada Paulista de Mastologia. Programação [Internet]. [cited on May 17, 2020]. Available at: <http://jornada.spmastologia.com.br/jpm-2020>
12. Brazilian Breast Cancer Symposium. Program [Internet]. [cited on May 12, 2020]. Available at: <https://2020.bbcs.org.br/program/>
13. Pinheiro CMA, Masson ALS, Faingezicht AM, Borghesi G, Rotea-Junior W, Prisco FE, et al. Estudos Brasileiros Apresentados nos Encontros Anuais da ASCO entre 2001 e 2007: Aumento de Produção, com Baixa Taxa de Publicação. *Rev Bras Cancerol*. 2009;55(3):221-7.
14. Comissão de Aperfeiçoamento de Pessoal de Ensino Superior. Plataforma Sucupira. Webqualis Capes [Internet]. [cited on May 2, 2020]. Available at: <https://sucupira.capes.gov.br/sucupira/public/consultas/coleta/veiculoPublicacaoQualis/listaConsultaGeralPeriodicos.jsf>
15. Associação Médica Brasileira e Conselho Federal de Medicina. Projeto Diretrizes [Internet]. [cited on Jan. 2, 2020]. Available at: [http://www.portalmédico.org.br/diretrizes/100\\_diretrizes/Texto\\_Introdutorio.pdf](http://www.portalmédico.org.br/diretrizes/100_diretrizes/Texto_Introdutorio.pdf)

16. MacDonald PL, Gardner RC. Type I error rate comparisons of posthocproceduresforIjChi-Squaretables. *Educ Psychol Meas.* 2000;60(5):735-754. <http://doi.org/10.1177/00131640021970871>
17. Brasil. Ministério da Saúde. Conselho Nacional de Saúde. Resolução nº 466, de 12 de dezembro de 2012. Aprova as diretrizes e normas regulamentadoras de pesquisas envolvendo seres humanos. *Diário Oficial da União.* 2013;(12 Seção 1):59.
18. Andrade VA, Carpini S, Schwingel R, Calderan TR, Fraga GP. Publication of papers presented in a Brazilian Trauma Congress. *Rev Col Bras Cir.* 2011;38(3):172-6. <https://doi.org/10.1590/S0100-69912011000300006>
19. Mokbel K. The Twenty-third Annual San Antonio Breast Cancer Symposium. *Curr Med Res Opin.* 2001;16(4):276-84. <https://doi.org/10.1185/030079901750120213>
20. Meissner A, Delouya G, Marcovitch D, Donath D, Taussky D. Publication rates of abstracts presented at the 2007 and 2010 Canadian Association of Radiation Oncology meetings. *Curr Oncol.* 2014;21(2):e250-4. <https://doi.org/10.3747%2Fco.21.1764>
21. Ohtori S, Orita S, Eguchi Y, Aoki Y, Suzuki M, Kubota G, et al. Oral Presentations Have a Significantly Higher Publication Rate, But Not Impact Factors, Than Poster Presentations at the International Society for Study of Lumbar Spine meeting: Review of 1126 Abstracts From 2010 to 2012 Meetings. *Spine (Phila Pa 1976).* 2018;43(19):1347-54. <https://doi.org/10.1097/BRS.0000000000002620>
22. Santos EF, Pereira MG. Qualidade dos resumos estruturados apresentados em congresso médico. *Rev Assoc Med Bras.* 2007;53(4):355-9. <https://doi.org/10.1590/S0104-42302007000400023>
23. Bertoldo JG, Coimbra JLM, Guidolin AF, Miqueloto A, Toaldo D. Uso ou abuso em testes de comparações de média: conhecimento científico ou empírico? *Ciência Rural.* 2008;38(4):1145-8. <https://doi.org/10.1590/S0103-84782008000400039>
24. Zorzetto R, Razzouk D, Dubugras MT, Gerolin J, Schor N, Guimarães JA, et al. The scientific production in health and biological sciences of the top 20 Brazilian universities. *Braz J Med Biol Res.* 2006;39(12):1513-20. <https://doi.org/10.1590/S0100-879X2006005000040>
25. Cardoso SC, Gattás GJF. The scientific production of full professors of the Faculdade de Medicina da Universidade de São Paulo: a view of the period of 2001-2006. *Clinics.* 2009;64(9):903-9. <https://doi.org/10.1590/S1807-59322009000900012>
26. Freitas PF, Freitas-Junior RF, Soares LR, Santos FC, Nazário ACP. Série temporal da apresentação de trabalhos brasileiros no San Antonio Breast Cancer Symposium. *Rev Bras Mastologia.* 2014;24(1):4-8. <https://doi.org/10.5327/Z201400010002RBM>
27. Kotiranta A, Tahvanainen A, Kovalainen A, Poutanen S. Forms and varieties of research and industry collaboration across disciplines. *Heliyon.* 2020;6(3):e03404. <https://doi.org/10.1016/j.heliyon.2020.e03404>
28. Balasubramanian SP, Kumar ID, Wyld L, Reed MW. Publication of surgical abstracts in full text: a retrospective cohort study. *Ann R Coll Surg Engl.* 2006;88(1):57-61. <https://doi.org/10.1308/003588406x82961>
29. Kinsella SD, Menge TJ, Anderson AF, Spindler KP. Publication rates of podium versus poster presentations at the American Orthopaedic Society for Sports Medicine meetings: 2006-2010. *Am J Sports Med.* 2015;43(5):1255-9. <https://doi.org/10.1177/0363546515573939>
30. XXIX Encontro Científico dos Acadêmicos de Medicina e VII Congresso Goiano de Ética Médica. *Rev Patol Trop.* 2017;46(2 Suppl. 2):1-166. <https://doi.org/10.5216/rpt.v46i2.49414>
31. 57º Congresso Brasileiro de Ginecologia e Obstetrícia. *Temas Livres aprovados e apresentados. Femina.* 2017;45(Spec. Ed.):1-148.
32. Mastology [Internet]. [cited on May 17, 2020]. Available at: <https://www.mastology.org/>
33. Sociedade Brasileira de Mastologia. Sobre nós [Internet]. [cited on May 12, 2018]. Available at: <http://www.sbmastologia.com.br/o-que-e-sbm/>



# Evaluation of sexual dysfunction in Brazilian women with breast cancer: partial results

Letícia Barbosa Sposito<sup>1</sup> , Caroline Nakano Vitorino<sup>2</sup> , Vanildo Prado<sup>1</sup> , Felipe Bedran Neto<sup>1</sup> ,  
Jair Verginio Junior<sup>1</sup> , Marco Aurélio Mestrinel<sup>1</sup> , Fernando Viana Hummel<sup>1</sup> , Daniel de Araújo Brito Buttros<sup>1\*</sup> 

## ABSTRACT

**Objective:** To assess the pattern of sexual performance in women treated for breast cancer. **Methods:** This is a cross-sectional study on women treated for breast cancer. Inclusion criteria: to have undergone the first-line therapy for cancer and the cancer not being classified as stage IV. Data on cancer were collected by the analysis of medical records. For the evaluation of sexual performance, women were submitted to individual interviews, with the application of the *Quociente Sexual – Versão Feminina* (QS-F) questionnaire. Sexual performance was classified as: bad, unfavorable, regular, good, and excellent. The diagnosis of sexual dysfunction was established to women with score  $\leq 60$ . For descriptive analyses, absolute (n) and relative (%) frequencies were performed, and for the comparison between the quantitative variables the Student's t-test was used. **Results:** 31 women with a mean age of 55.2 years were included, 35% were classified as clinical stage II, 84% underwent conservative surgery, 65% underwent chemotherapy, and 80% used endocrinotherapy. Regarding sexual performance, 62% spontaneously think about sex, 35% are always interested in sex, and 51.7% have some degree of pain during intercourse. After calculating the score, it was concluded that 6.5% had bad sexual performance; 19.4%, unfavorable; 19.4%, regular; 41.9%, good; and 12.8%, excellent. The mean score was 58.7 points (standard deviation = 21.4, median of 64, minimum of 16, and maximum of 90 points), and 45.2% of women were diagnosed with sexual dysfunction. The provided treatments and the length of follow-up did not have a significant correlation with sexual performance. **Conclusion:** Most women treated for breast cancer had sexual performance classified as “good and excellent,” although a significant percentage had a diagnosis of sexual dysfunction.

**KEYWORDS:** breast neoplasms; sexuality; dyspareunia; quality of life.

## INTRODUCTION

In recent decades, the number of patients who survive breast cancer has increased<sup>1</sup>. The results of this increase are partly due to the greater effectiveness of adjuvant treatments<sup>1</sup>. According to data from the National Cancer Institute (INCA), breast cancer is the leading cause of death due to cancer among women in Brazil<sup>2</sup>. The survival rate for patients with this type of cancer is approximately 76% to 92% worldwide<sup>3</sup>, directly depending on initial staging and the tumor subtype.

Technological advances in the healthcare area have resulted in chronic conditions and increased patient survival<sup>4,5</sup>. In this context, oncology is highlighted, and the need for assessing and prioritizing the quality of life of oncologic patients arises<sup>4,6</sup>. According to the World Health Organization (WHO), quality of

life is defined as: “The individual’s perception of their position in life in the context of the culture and value systems in which they live and in relation to their goals, expectations, standards and concerns”<sup>2</sup>. Sexual health is directly related to quality of life and must be addressed with specialized approach<sup>1</sup>. Sexual dysfunction is frequent among women, and the prevalence rate ranges between 9% and 43%<sup>7</sup>.

Sexual health has been recently recognized as one of the areas of concern in patients who survive breast cancer and one of the aspects of care that is overlooked by healthcare professionals<sup>1</sup>.

Female sexual dysfunctions include abnormalities in sexual desire, arousal, lubrication, satisfaction, and dyspareunia, which is one of the most common complications in patients with breast cancer<sup>3</sup>.

<sup>1</sup>Centro Universitário Claretiano – Rio Claro (SP), Brazil.

<sup>2</sup>Santa Casa de Misericórdia de Rio Claro – Rio Claro (SP), Brazil.

\*Corresponding author: [danielbuttros@claretiano.edu.br](mailto:danielbuttros@claretiano.edu.br)

Conflict of interest: nothing to declare.

Received on: 05/08/2020 Accepted on: 09/14/2020

Sexual dysfunctions among women treated for breast cancer are common, and most women have some degree of sexual dysfunction after undergoing treatment<sup>7</sup>.

The etiology of female sexual dysfunctions is heterogeneous and multifactorial, with complex symptoms that may respond to multimodal therapies<sup>8</sup>.

The approach to sexual dysfunction requires knowledge on the part of healthcare professionals, and the treatment depends on the correct etiology identification.

The aim of this study was to assess the pattern of sexual performance in women treated for breast cancer.

## METHODS

This is a cross-sectional clinical study. Inclusion criteria were as follows:

- to present histopathological diagnosis of breast cancer;
- to have undergone the first-line therapy for cancer (surgery, chemotherapy, and radiotherapy);
- to be classified in stages I, II, or III;
- to have been seen in medical services of the Brazilian Unified Health System;
- to have signed the informed consent form.

Sample size calculation was based on the study conducted by Jing et al.<sup>3</sup>, who found sexual dysfunction in 73.4% of women treated for breast cancer<sup>7</sup>. Taking this frequency into consideration, with a 5% significance level and type II error of 10% (90% test power), the need for evaluating at least 176 patients with breast cancer was estimated. This publication presents partial results of the current research.

Data on cancer, such as staging, treatment, and length of follow-up, were collected by analyzing medical records.

For evaluating sexual performance, women were submitted to individual interviews with the application of the *Quociente Sexual – Versão Feminina* (Female Sexual Quotient – QS-F) questionnaire<sup>9</sup> (Appendix 1) (all interviews were conducted by the same researcher – Sposito, LB).

The QS-F is composed of 10 objective questions, and each question scores from 0 to 5, according to the answers: never (0), rarely (1), sometimes (2), often (3), usually (4), always (5). The result of the sum of the 10 answers must be multiplied by 2, which results in a total index ranging from 0 to 100. The seventh question must be differently addressed, that is, the value of the answer (from 0 to 5) must be subtracted from 5 in order to have the final score.

The value of the final sum indicates better sexual performance/satisfaction, namely:

- 82 – 100 points: good to excellent;
- 62 – 80 points: regular to good;
- 42 – 60 points: unfavorable to regular;

- 22 – 40 points: bad to unfavorable;
- 0 – 20 points: null to bad.

The diagnosis of sexual dysfunction was given to women with score  $\leq 60$ , considering that score  $> 60$  corresponds to normality<sup>9</sup>.

For the statistical study, a descriptive analysis of the data was performed using absolute (n) and relative (%) frequencies, measures of central tendency (mean and median) and dispersion (standard deviation [SD], minimum and maximum values). For the comparison between the quantitative variables and the outcome “sexual life in the last six months” grouped into “good to excellent” and “regular to bad,” the Student’s t-test was used. In the association between qualitative predictor variables and the outcome, the Fisher’s exact test was used. For statistical significance,  $p < 0.050$  was considered. Data were entered into an Excel spreadsheet and analyzed using the Statistical Package for the Social Sciences (SPSS) software, version 23.0 for Windows.

The study was submitted to and approved by the Research Ethics Committee, Plataforma Brasil/CAAE: 02241618.1.0000.5381.

## RESULTS

A total of 31 women diagnosed with breast cancer were evaluated. The mean age was 55.2 years (SD = 11.1), with a median of 55, ranging between 23 and 77 years.

Graph 1 shows the percentage distribution, and in absolute number, of the clinical stage of the study patients.

Table 1 shows that all women underwent surgery; 83.9% underwent conservative surgery; 96.8%, radiotherapy; 80.7%, endocrinotherapy; and 64.5%, chemotherapy.

Table 2 describes all the questions of the QS-F. It is noteworthy that approximately 40% of women “never” tend to spontaneously think about sex, remember sex, or imagine themselves having sex. However, 35.5% are “always” interested in sex in such a way to willingly engage in intercourse. When asked if the degree of satisfaction with intercourse makes them want to have sex at other times,

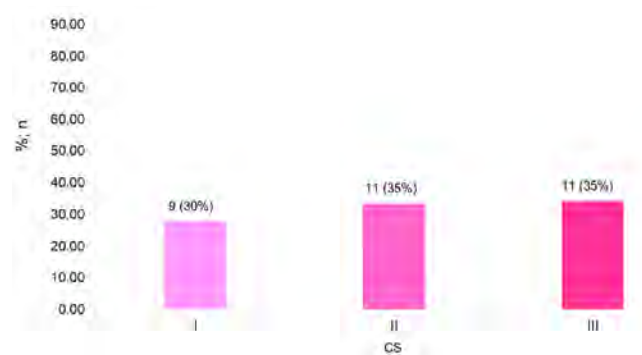

\*Values expressed as numbers and percentage; CS: clinical stage.

**Graph 1.** Number and percentage of women with invasive breast cancer according to clinical stage at the time of diagnosis\*.

**Table 1.** Number and percentage of women with invasive breast cancer according to treatment\*.

Variables	Categories	n	%
Surgery	Mastectomy	5	16.1
	Conservative surgery	26	83.9
Chemotherapy	No	11	35.5
	Yes	20	64.5
Endocrinotherapy	No	6	19.3
	Yes	25	80.7
Radiotherapy	No	1	3.2
	Yes	30	96.8
Total		31	100.0

\*Values expressed as numbers and percentage.

**Table 2.** Number and percentage of women with invasive breast cancer according to questions of the Female Sexual Quotient questionnaire.

Variables	Categories	n	%
Q1. Do you usually have spontaneous thoughts about sex, remember sex, or imagine yourself having sex?	Never	12	38.7
	Rarely	5	16.1
	Sometimes	6	19.4
	Often	5	16.1
	Usually	3	9.7
Q2. Are you interested enough in sex to willingly engage in intercourse?	Never	6	19.4
	Rarely	4	12.9
	Sometimes	3	9.7
	Often	5	16.1
	Usually	2	6.5
Q3. Does foreplay (caresses, kisses, hugs, cuddles, etc.) encourage you to continue intercourse?	Never	2	6.5
	Rarely	4	12.9
	Sometimes	2	6.5
	Often	1	3.2
	Usually	6	19.4
Q4. Do you usually get lubricated during intercourse?	Never	9	29.0
	Rarely	3	9.7
	Sometimes	5	16.1
	Often	1	3.2
	Usually	3	9.7
Q5. During intercourse, as your partner's arousal increases, do you feel more stimulated to have sex?	Never	2	6.5
	Rarely	4	12.9
	Sometimes	3	9.7
	Usually	3	9.7
	Always	19	61.3
Q6. During intercourse, do you relax the vagina enough to facilitate penile penetration?	Never	5	16.1
	Rarely	1	3.2
	Often	3	9.7
	Usually	3	9.7
	Always	19	61.3
Q7. Do you usually feel pain during intercourse when the penis penetrates your vagina?	Never	14	45.2
	Rarely	1	3.2
	Sometimes	3	9.7
	Often	3	9.7
	Usually	3	9.7
Q8. Can you be engaged, without getting distracted (without losing concentration), in and during intercourse?	Never	4	12.9
	Rarely	2	6.5
	Sometimes	4	12.9
	Often	3	9.7
	Usually	2	6.5
Q9. Can you reach orgasm (maximum pleasure) in the intercourses you engage in?	Never	6	19.4
	Rarely	7	22.6
	Sometimes	4	12.9
	Often	2	6.5
	Usually	1	3.2
Q10. Does the degree of satisfaction you feel from intercourse make you desire to have sex at other times, on other days?	Never	6	19.4
	Rarely	4	12.9
	Sometimes	3	9.7
	Often	3	9.7
	Usually	2	6.5
Total		31	100.0

**Table 2.** Continuation.

Variables	Categories	n	%
Q5. During intercourse, as your partner's arousal increases, do you feel more stimulated to have sex?	Never	2	6.5
	Rarely	4	12.9
	Sometimes	3	9.7
	Usually	3	9.7
	Always	19	61.3
Q6. During intercourse, do you relax the vagina enough to facilitate penile penetration?	Never	5	16.1
	Rarely	1	3.2
	Often	3	9.7
	Usually	3	9.7
	Always	19	61.3
Q7. Do you usually feel pain during intercourse when the penis penetrates your vagina?	Never	14	45.2
	Rarely	1	3.2
	Sometimes	3	9.7
	Often	3	9.7
	Usually	3	9.7
Q8. Can you be engaged, without getting distracted (without losing concentration), in and during intercourse?	Never	4	12.9
	Rarely	2	6.5
	Sometimes	4	12.9
	Often	3	9.7
	Usually	2	6.5
Q9. Can you reach orgasm (maximum pleasure) in the intercourses you engage in?	Never	6	19.4
	Rarely	7	22.6
	Sometimes	4	12.9
	Often	2	6.5
	Usually	1	3.2
Q10. Does the degree of satisfaction you feel from intercourse make you desire to have sex at other times, on other days?	Never	6	19.4
	Rarely	4	12.9
	Sometimes	3	9.7
	Often	3	9.7
	Usually	2	6.5
Total		31	100.0

\*Values expressed as numbers and percentage; QS-F: Female Sexual Quotient questionnaire.

on other days, 41.9% of women answered “always.” As for the general score (Graph 2), 41.9% were classified as having regular to good sexual performance, and 12.9% as good to excellent. The mean score was 58.7 points (SD = 21.4), median of 64, minimum of 16, and maximum of 90 points. Considering the concept of sexual dysfunction in women with scores ≥ 60, 45.2% of women received this diagnosis.

Continue...

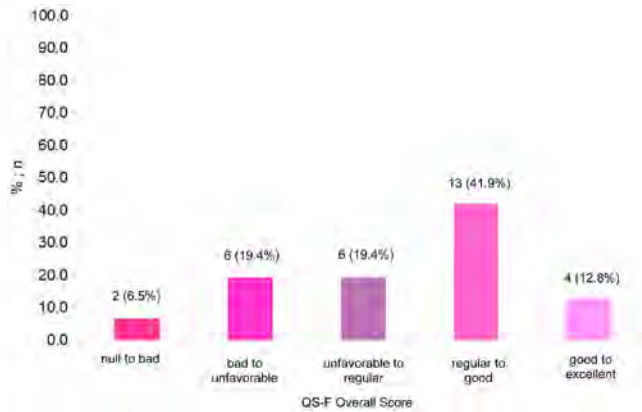

\*Values expressed as numbers and percentage; QS-F: Female Sexual Quotient questionnaire.

**Graph 2.** Number and percentage of women treated for breast cancer in relation to sexual performance (according to the Female Sexual Quotient questionnaire)\*.

In the inferential analysis, the QS-F outcome variable was grouped into two groups: “good to excellent” (regular to good + good to excellent) and “regular to bad” (null to bad + bad to unfavorable + unfavorable to regular). There was no statistical difference between groups according to age ( $p = 0.311$ ) and length of follow-up ( $p = 653$ ) (values are presented in Table 3).

Table 4 demonstrates that there was no statistically significant association between the clinical stage and cancer treatments *versus* the classification of sexual life in the last six months.

## DISCUSSION

This study demonstrated that most women treated for breast cancer (41.9%) classified their sexual performance as “regular to good,” according to the application of the QS-F questionnaire. A total of 38% of women classified the sexual performance as “bad to unfavorable” and “unfavorable to regular” (19.4% each). The extreme ratings, “good to excellent” and “null to bad,” were associated with 12.9% and 6.5% of women, respectively. The diagnosis of sexual dysfunction was given to 45.2% of women, demonstrating that strategies for approaching and treating this population must be taken into account.

The QS-F was developed in the *Programa de Estudos em Sexualidade* (Program of Studies on Sexuality – ProSex) of the Psychiatry Institute of Hospital das Clínicas, Medical School – University of São Paulo<sup>9</sup>. Validation was performed by comparing the mean scores of women with sexual dysfunction and others who did not have the problem. Both groups were categorized as for sociodemographic characteristics. The QS-F comprises ten objective questions and classifies the pattern of sexual dysfunction as: bad, unfavorable, regular, good, and excellent<sup>9</sup>. This questionnaire can be interpreted in terms of total score,

**Table 3.** Comparison between the variable age and length of follow-up *versus* Female Sexual Quotient questionnaire\*.

Variable	Categories (QS-F)	n	Mean	SD	p-value
Age	good to excellent	17	53.294	12.7317	0.311
	regular to bad	14	57.429	8.7417	
Length of follow-up	good to excellent	17	4.294	2.9742	0.653
	regular to bad	14	4.714	1.9386	

\*Values expressed as numbers, mean, standard deviation (SD), and p-value; QS-F: Female Sexual Quotient questionnaire.

**Table 4.** Association between predictor variables and the outcome of the Female Sexual Quotient questionnaire\*.

Variables	Categories	QS-F				p-value
		Good to excellent		Regular to bad		
		n	%	n	%	
CS	I	5	29.4	4	28.6	0.899
	II	5	29.4	6	42.9	
	III	7	41.2	4	28.6	
Surgery	Mastectomy	2	11.8	3	21.4	0.636
	Quadrantectomy	15	88.2	11	78.6	
CT	No	5	29.4	6	42.9	0.477
	Yes	12	70.6	8	57.1	
HT	No	2	11.8	4	28.6	0.370
	Yes	15	88.2	10	71.4	
RT	No	1	5.9	0	0.0	1.000
	Yes	16	94.1	14	100.0	
Total		17	100.0	14	100.0	

\*Values expressed as numbers and percentage; CS: clinical stage; CT: chemotherapy; HT: hormone therapy; RT: radiotherapy; QS-F: Female Sexual Quotient questionnaire.

assessing the general quality of women’s sexual performance/satisfaction. Conversely, for comprising all phases of the sexual response cycle, in addition to associated domains, the instrument also indicates the difficulties of each patient according to specific aspects of the responses. Therefore, through ten self-administered questions, the QS-F assesses all phases of the sexual response cycle, including other domains, namely: sexual desire and interest (questions 1, 2, and 8); foreplay (question 3); personal arousal and attunement with the partner (questions 4 and 5); comfort (questions 6 and 7); orgasm and satisfaction (questions 9 and 10). Low scores for questions 1, 2, and 8 mean



that sexual desire is not enough for the woman to be interested and satisfied with the intercourse. Questions 3, 4, 5, and 6 assess different aspects of the female arousal phase during intercourse (response to foreplay, lubrication, attunement with the partner, and reception to penetration). Low scores for these questions indicate little capacity of engagement and decreased response to sexual stimulation. A high score for question 7 confirms the presence of pain in the relationship. Difficulty with orgasm and little or no satisfaction with sex are evidenced by low scores for questions 9 and 10<sup>9</sup>.

Considering the different phases of the sexual response cycle addressed by the QS-F, the present study demonstrated that, according to the concept of sexual desire and interest, 38.7% of women responded they never think about sex. In comparison with general data of the Brazilian population, such value is much higher than 8.2% of women who have no interest in sex<sup>9</sup>. On the other hand, 58.1% of women always, usually, or often willingly engage in intercourses, and 51.6% are always engaged in intercourse without being distracted. This fact demonstrates that, despite not thinking about sex, most women have some degree of satisfaction during sex. Within this context, foreplay plays an important role, with 71% of women stating that usually, or always, foreplay encourages them to continue the intercourse.

Regarding the concept of personal arousal and attunement with the partner, addressed by questions 4 and 5, most women never, rarely, or sometimes get lubricated during intercourse. Conversely, 71% of women reported that they are often or always aroused by the partner's excitement. Regarding comfort during sex, 80.7% of women responded they relax the vagina during penetration, and 51.7% have some degree of pain during sex. This fact is alarming, considering that the index of the general Brazilian population that refers to some degree of dyspareunia is 17.8%<sup>9</sup>. In this regard, it is worth mentioning that vaginal dryness is common in women treated for breast cancer<sup>10</sup>. This is due to the postmenopausal status faced by most women, either because of premature ovarian insufficiency resulting from systemic treatment, or because of their age at the time of diagnosis. Hormone replacement therapy is contraindicated for this population<sup>10</sup>. The treatment of choice for genitourinary symptoms in women with personal history of breast cancer consists in lubricants and pelvic floor physiotherapy. Topical hormone therapy can also be considered, depending on the cancer treatment the patient is currently undergoing. For women who do not respond to first-line therapy, and who choose not to use topical hormone therapy, the use of vaginal laser is an option<sup>10,11</sup>.

Finally, when assessing the phases of the sexual response cycle, 19.4% of women responded that they never reach orgasm during intercourse. In comparison with national data, this number is lower than the 26.2% of healthy women who reported the same fact. Conversely, 67.8% responded that the satisfaction with intercourse makes them desire to have sex on other days.

In a recent publication of the *Journal of Clinical Oncology*, psychosocial and/or psychosexual therapy is recommended for all cancer patients, aiming at improving sexual response, body image, intimacy and relationship issues, and the overall sexual function and satisfaction. First, factors contributing to cancer and treatable factors must be identified and addressed. In addition to the aforementioned treatments for genitourinary symptoms, both women and men with vasomotor symptoms should be cared for treating these symptoms, including behavioral options, such as cognitive behavioral therapy, slow breathing and hypnosis, and medications such as venlafaxine and gabapentin<sup>11</sup>. The latest meta-analysis published on the Cochrane platform, in 2016, on interventions in sexual dysfunction during cancer treatment in women included 1,509 women randomized in 11 trials. All studies investigated interventions after treatment for both gynecologic cancer and breast cancer. Eight studies evaluated a psychotherapeutic or psychopedagogical intervention. Two studies evaluated a pharmaceutical intervention and a pelvic floor exercise. All trials involved heterosexual women. In trials that evaluated a psychotherapeutic intervention, the effect on sexual dysfunction varied; in three studies, benefit for some measures of sexual function was reported; and in five studies, no benefit was found. The evidence on pharmaceutical interventions and pelvic floor exercise was inconclusive. Only the study on a pH-balanced vaginal gel found significant improvements in sexual function<sup>12</sup>.

In practical terms, the treatment of women with breast cancer and sexual dysfunction must follow a safe and reliable pattern. Behavioral and non-pharmacological measures are the ones chosen for initiating the approach: sex therapy, lubricants, vaginal moisturizers, self-stimulators (vibrators), vaginal dilators, and pelvic floor physiotherapy. In case these methods do not work, vaginal laser is a great option, with great results in the treatment of vaginal atrophy. Women with persistent and severe symptoms, who did not respond to non-hormonal treatments and who present factors that suggest a low risk of recurrence, may be candidates for local hormone therapy such as estradiol-based creams<sup>10</sup>. Understanding the approach and treatment of women is essential, considering that the prevalence of sexual dysfunction in this population is high, accounting for 73%<sup>3</sup>.

In this study there was no statistical correlation between the cancer treatments and sexual dysfunction. Hence, the authors believe that the absence of significant results was due to the small number of research participants (31 women). The literature corroborates this finding. A study published in 2019 included interviews with 278 sexually active women. Overall, 65%, 27%, and 8% underwent mastectomy, mastectomy with breast reconstruction, and simple mastectomy, respectively. In total, 74.5% reported undergoing radiotherapy; 47.8%, chemotherapy; 27.3%, use of tamoxifen; and 31.4%, use of aromatase inhibitor (AI).

There was no significant difference in the prevalence of sexual dysfunction per surgical modality, even when adjusted for adjuvant treatment. Chemotherapy or radiotherapy had no association with sexual dysfunction either. The only type of therapy that was correlated with sexual dysfunction was the use of AI, 1.6 times higher in the group who used the medication ( $p = 0.01$ ). The researchers concluded that the highest rates of sexual dysfunction were among breast cancer survivors treated with AI. Surgical modality, chemotherapy, and radiotherapy were not associated with sexual dysfunction<sup>13</sup>.

The present study presents partial results from a sample of women treated for breast cancer. The results were not statistically significant, but these data are worth of attention, and new national studies should be encouraged. Sexual dysfunction affects most of the study patients, and mastologists must be prepared to address, identify, and treat this pathology that severely impairs the quality of life.

## CONCLUSION

Most women treated for breast cancer had sexual performance classified as “good and excellent,” although a significant percentage had a diagnosis of sexual dysfunction. Dyspareunia is the most prevalent symptom when compared with the population without breast cancer.

## AUTHORS' CONTRIBUTIONS

LS: Investigation.

CV: Conceptualization.

VP: Methodology.

FN: Methodology.

FF: Investigation.

MM: Supervision.

JJ: Supervision.

DB: Supervision, Project administration.

## REFERENCES

1. Soldera SV, Ennis M, Lohmann AE, Goodwin PJ. Sexual health in long-term breast cancer survivors *Breast Cancer Res Treat*. 2018;172(1):159-66. <http://doi.org/10.1007/s10549-018-4894-8>
2. Instituto Nacional de Câncer. Portal [Internet]. Rio de Janeiro: INCA [cited on Sept. 12, 2019]. Available from: <http://www.inca.gov.br>
3. Jing L, Zhang C, Li W, Jin F, Wang A. Incidence and severity of sexual dysfunction among women with breast cancer: a meta-analysis based on female sexual function index. *Support Care Cancer*. 2019;27(4):1171-80. <http://doi.org/10.1007/s00520-019-04667-7>
4. Makluf ASD, Dias RC, Barra AA. Avaliação da qualidade de vida em mulheres com câncer da mama. *Rev Bras Cancerol*. 2006;52(1):49-58.
5. Sehati Shafae F, Mirghafourvand M, Harischi S, Esfahani A, Amirzehni J. Self-Confidence and Quality of Life in Women Undergoing Treatment for Breast Cancer. *Asian Pac J Cancer Prev*. 2018;19(3):733-40. <https://doi.org/10.22034/APJCP.2018.19.3.733>
6. Coady D, Kennedy V. Sexual Health in Women Affected by Cancer: Focus on Sexual Pain. *Obstet Gynecol*. 2016;128(4):775-91. <https://doi.org/10.1097/aog.0000000000001621>
7. Panjari M, Bell RJ, Davis SR. Sexual function after breast cancer. *J Sex Med*. 2011;8(1):294-302. <https://doi.org/10.1111/j.1743-6109.2010.02034.x>
8. Weinberger JM, Houman J, Caron AT, Anger J. Female Sexual Dysfunction: A Systematic Review of Outcomes Across Various Treatment Modalities. *Sex Med Rev*. 2019;7(2):223-50. <https://doi.org/10.1016/j.sxmr.2017.12.004>
9. Abdo CHN. Quociente Sexual Feminino: Um Questionário Brasileiro para Avaliar a Atividade Sexual da Mulher. *Diagn Tratamento*. 2009;14(2):89-1.
10. Faubion SS, Larkin LC, Stuenkel CA, Bachmann GA, Chism LA, Kagan R, et al. Management of genitourinary syndrome of menopause in women with or at high risk for breast cancer: consensus recommendations from The North American Menopause Society and The International Society for the Study of Women's Sexual Health. *Menopause*. 2018;25(6):1-13. <https://doi.org/10.1097/GME.0000000000001121>
11. Carter J, Lacchetti C, Andersen BL, Barton DL, Bolte S, Damast S, et al. Interventions to Address Sexual Problems in People With Cancer: American Society of Clinical Oncology Clinical Practice Guideline Adaptation of Cancer Care Ontario Guideline. *J Clin Oncol*. 2018;36(5):492-511. <https://doi.org/10.1200/jco.2017.75.8995>
12. Candy B, Jones L, Vickerstaff V, Tookman A, King M. Interventions for sexual dysfunction following treatments for cancer in women. *Cochrane Database Syst Rev*. 2016;(2):CD005540. <https://doi.org/10.1002/14651858.CD005540.pub3>
13. Gandhi C, Butler E, Pesek S, Kwiat R, Edmonson D, Raker C, et al. Sexual Dysfunction in Breast Cancer Survivors. Is it Surgical Modality or Adjuvant Therapy? *Am J Clin Oncol*. 2019;42(6):500-6. <https://doi.org/10.1097/coc.0000000000000552>

**Appendix 1.** Female Sexual Quotient (QS-F) questionnaire.

Answer this questionnaire with honesty, based on the last six months of your sex life, considering the following score:

0 = never

1 = rarely

2 = sometimes

3 = often 4 = usually

5 = always

1. Do you usually have spontaneous thoughts about sex, remember sex, or imagine yourself having sex?  
( ) 0 ( ) 1 ( ) 2 ( ) 3 ( ) 4 ( ) 5
2. Are you interested enough in sex to willingly engage in intercourse?  
( ) 0 ( ) 1 ( ) 2 ( ) 3 ( ) 4 ( ) 5
3. Does foreplay (caresses, kisses, hugs, cuddles, etc.) encourage you to continue intercourse?  
( ) 0 ( ) 1 ( ) 2 ( ) 3 ( ) 4 ( ) 5
4. Do you usually get lubricated during intercourse?  
( ) 0 ( ) 1 ( ) 2 ( ) 3 ( ) 4 ( ) 5
5. During intercourse, as your partner's arousal increases, do you feel more stimulated to have sex?  
( ) 0 ( ) 1 ( ) 2 ( ) 3 ( ) 4 ( ) 5
6. During intercourse, do you relax the vagina enough to facilitate penile penetration?  
( ) 0 ( ) 1 ( ) 2 ( ) 3 ( ) 4 ( ) 5
7. Do you usually feel pain during intercourse when the penis penetrates your vagina?  
( ) 0 ( ) 1 ( ) 2 ( ) 3 ( ) 4 ( ) 5
8. Can you be engaged, without getting distracted (without losing concentration), in and during intercourse?  
( ) 0 ( ) 1 ( ) 2 ( ) 3 ( ) 4 ( ) 5
9. Can you reach orgasm (maximum pleasure) in the intercourses you engage in?  
( ) 0 ( ) 1 ( ) 2 ( ) 3 ( ) 4 ( ) 5
10. Does the degree of satisfaction you feel from intercourse make you desire to have sex at other times, on other days?  
( ) 0 ( ) 1 ( ) 2 ( ) 3 ( ) 4 ( ) 5

Answer key

Result = sexual performance pattern:

82-100 points	<i>Good to excellent</i>
62-80 points	<i>Regular to good</i>
42-60 points	<i>Unfavorable to regular</i>
22-40 points	<i>Bad to unfavorable</i>
0-20 points	<i>Null to bad</i>

How to get the result:

Add the points assigned to each question, subtract 5 points from question 7, and multiply the total by 2:

$2 \times (Q1 + Q2 + Q3 + Q4 + Q5 + Q6 + [5-Q7] + Q8 + Q9 + Q10)$   
(Q = question)

**[5-Q 7]** = Question 7 requires this subtraction to be previously done and the result to be included in the sum of the questions.



# Impact of mammography screening on the treatment of women diagnosed with breast cancer

Laura Ugioni<sup>1\*</sup>, Laura Carminatti<sup>1</sup>, Alessandra Beatris Rovaris<sup>1</sup>, Luiza Ramos<sup>2</sup>

## ABSTRACT

**Objective:** To evaluate the influence of mammographic screening on the treatment of women with previous diagnosis of breast cancer. **Method:** Cross-sectional, descriptive, observational study, with primary and secondary data collection and quantitative approach. It was performed in a high complexity hospital in the South region of Santa Catarina, Brazil, where patients with previous history of breast cancer were evaluated during the period from 2012 to 2017, and who were undergoing oncological follow-up at the same hospital. The variables were expressed as frequency and percentage. Inferential statistical analyses were performed with a significance level of  $\alpha = 0.05$  and, therefore, 95% confidence interval. Therefore, the confidence interval was 95%. Associations between variables were investigated using the Pearson's  $\chi^2$  and the likelihood ratio tests. **Results:** Among the 99 analyzed patients, 58.6% annually performed the examination and 49.5% had elapsed less than 12 months between the last performed mammogram and the diagnosis. There was a higher frequency of stage I disease, corroborating the results that 74.7% of patients underwent breast-conserving surgeries and 68.7% underwent sentinel lymph node biopsy, rather than extensive surgeries. Regarding the treatment of choice, patients with annual or biennial mammographic frequency had similar surgical and chemotherapeutic outcomes in relation to patients who had a mammogram without defined frequency or who had never undergone it. **Conclusion:** Patients who underwent mammography on an annual frequency and those whose time between the last mammogram and the diagnosis of cancer was less than 12 months had tumors of lesser extent at diagnosis; however, it did not influence the type of treatment chosen.

**KEYWORDS:** mammography; breast neoplasms; mass screening; prognosis; combined modality therapy.

## INTRODUCTION

Breast cancer is the leading cause of cancer-related deaths in women worldwide. The highest mortality rate from this type of disease is verified in low- and middle-income developing countries, where about 70% of these deaths take place<sup>1</sup>. It is the most common cancer in women in Brazil and worldwide, when disregarding the prevalence of nonmelanoma skin tumors<sup>2</sup>, and the invasive ductal carcinoma is the most common histological type, with a prevalence of 80% to 90% of cases<sup>3</sup>. The incidence of breast cancer in women varies more than ten times throughout continents, and mortality varies up to four times<sup>1</sup>.

Breast cancer is a very heterogeneous disease due to the plasticity of its cells. Hence, the stratification of tumors is paramount to achieve better clinical results<sup>4</sup>. In recent years, an exponential progress has been made in the molecular analysis of breast

tumors, with profound implications for understanding the biology of cancer and, consequently, for its classification, allowing greater individualization and optimization of treatment.

Biomarkers of expression of estrogen receptor (ER), progesterone receptor (PR), and expression or amplification of the human epidermal growth factor receptor 2 (HER2) are part of the diagnosis of the tumor aiming at refining the classification, predicting the prognosis and, finally, individualizing the treatment of breast cancer according to the disease subtype<sup>5</sup>.

Screening for breast cancer often allows for diagnosis at earlier stages of the disease, even without lymph node involvement, and is manifested by the presence of smaller tumors. Consequently, there is a decrease in the need for extensive medical interventions and surgical approaches. Therefore, when making a decision regarding the use of mammography, one should not only take

<sup>1</sup>Universidade do Extremo Sul Catarinense – Criciúma (SC), Brazil.

<sup>2</sup>Hospital São José – Criciúma (SC), Brazil.

\*Corresponding author: lauraugioni@hotmail.com

Conflict of interests: nothing to declare.

Received on: 03/13/2020. Accepted on: 08/31/2020.

into account the survival advantage, but also the advantage of avoiding highly aggressive treatments<sup>6</sup>. That is why mammography screening is believed to save lives and has been the main pillar of screening for breast cancer<sup>7</sup>.

There are many factors that must be considered when discussing the effectiveness of screening programs, assessing the positive aspects and not neglecting the negative ones as for the conduct in decision-making. Potential damage from screening includes anxiety, the cost of the test, and the morbidity associated with biopsies diagnosed as false-positive<sup>8</sup>.

The combined action of mammography exam and the regular use of adjuvant therapies in the early detection and treatment of breast cancer has been decisive in considerably reducing mortality from this disease in recent decades. The prognosis in each woman is closely related to the tumor's genetic profile and, although findings on imaging studies may be nonspecific, there are cases in which characteristic traits that guide a specific molecular subtype can be identified<sup>9</sup>.

Because of multiple prognostic factors that must be taken into account when considering eligibility for treatment, such as age, reproductive status (before or after menopause), type, and severity of cancer, it is not possible to establish clear standards of conduct regarding the disease, as there are many different clinical situations<sup>10</sup>. The treatment of breast cancer is complex and requires a multidisciplinary approach, which may include surgery, radiotherapy, and systemic therapy (chemotherapy, hormonal, or biological therapy)<sup>11</sup>.

As previously described, mammography is the most important method of screening for breast cancer, representing a fundamental tool for the assessment and clarification of the various abnormalities found in the breasts. Considering its importance, the objective of the present study was to evaluate the influence of mammographic screening on the treatment of women with a previous diagnosis of breast cancer and who were undergoing outpatient follow-up care.

## METHODS

### Ethical considerations

The data of the present study were only collected after approval by the Human Research Ethics Committee of Universidade do Extremo Sul Catarinense, under opinion No. 3.084.495, and by the Research Ethics Committee of the hospital where the study was carried out, under opinion No. 3,202,104.

### Study design

This is a cross-sectional, descriptive, observational study, with primary and secondary data collection and quantitative approach. The analysis was carried out in a public hospital of regional reference located in the city of Criciúma, in the South of the state

of Santa Catarina, Brazil. The evaluated patients were women, with a previous diagnosis of breast cancer during the period from 2012 to 2017, and who were undergoing outpatient follow-up care at the same hospital.

106 patients were evaluated. Of these, seven were excluded due to incomplete information in the medical records or because they had not yet completed the treatment. Therefore, a total of 99 patients were included in the study in order to assess the relationship between the date of the last mammography prior to diagnosis and the frequency with which the examination was performed, and TNM staging (extension of the primary tumor, lymph nodes affected by metastasis, and distant metastasis) at the time of diagnosis and the therapy adopted for each tumor stage.

For the collection of secondary data, the following information was extracted from the medical records: age of the patient (40–49 years, 50–59 years, 60–69 years, ≥70 years); skin color (white, black, or other); menopausal status (pre- or postmenopausal); tumor characteristics, such as TNM staging and immunohistochemistry; type of breast surgery (breast-conserving or mastectomy); axillary surgery (sentinel lymph node, axillary dissection, or none); and chemotherapy (adjuvant, neoadjuvant, or none).

Primary data were collected through a questionnaire applied and developed by the researchers. It contained two items:

- time elapsed between the last mammography before the diagnosis of breast cancer and the diagnosis (more than 24 months, between 12–24 months, or less than 12 months);
- frequency of mammography screening (annually, biannually, undefined frequency, or had never performed).

### Statistical analysis

The collected data were organized and analyzed using the IBM Statistical Package for the Social Sciences (SPSS) software, version 21.0. Variables were expressed as frequency and percentage. Inferential statistical analyses were performed with a significance level of  $\alpha = 0.05$ . Therefore, the confidence interval was 95%.

Associations between the variables were investigated by applying the Pearson's  $\chi^2$  and likelihood ratio tests, with subsequent analysis of residuals in cases that showed statistical significance.

## RESULTS

The clinical and epidemiological profile of the 99 patients analyzed in the present study is described in Table 1, which shows characteristics, such as the age, skin color, and menopausal status of each patient, in addition to the TNM staging of the tumors and immunohistochemical characteristics such as expression of estrogen receptor (ER), progesterone receptor (PR), expression or amplification of human epidermal growth factor receptor 2 (HER2), and cell proliferation marker (Ki67).

When analyzing the therapy adopted for each patient, regarding the type of breast surgery, 74.7% (74/99) of them underwent breast-conserving surgery and 25.3% (25/99), mastectomy. Concerning the axillary approach, 68.7% (68/99) underwent sentinel lymph node biopsy; 27.3% (27/99) required lymph node dissection; and 4% (4/99) did not undergo any axillary surgical approach. As for chemotherapy, 34.3% (34/99) of them underwent adjuvant chemotherapy; 33.3% (33/99), neoadjuvant chemotherapy; and 32.3% (32/99), none.

The participants of the present study were also asked about the time elapsed between the last mammography before the diagnosis and the diagnosis of cancer, and 33.3% (33/99) stated that more than 24 months had passed; 17.2% (17/99), between 12 and 24 months; and 49.5% (49/99), less than 12 months. They were also asked about the frequency of mammography screening: 58.6% (58/99) answered that they annually performed it; 3% (3/99), biannually; 20.2% (20/99) reported undefined frequency; and 18.2% (18/99) had never done it.

The correlation between the date of the last mammography prior to the diagnosis and the frequency with which the examination was performed with the TNM staging at diagnosis is demonstrated in Tables 2 and 3.

Table 2 shows the relationship between the time elapsed between the last mammography performed by the patient and the diagnosis of breast cancer with TNM staging. Based on the extension of the primary tumor, it was observed that the performance of the last mammography in less than 12 months until the diagnosis was correlated with tumors of smaller extension ( $p=0.026$ ).

When analyzing lymph nodes affected by metastasis and the presence or absence of distant metastases, it was also found that the shorter the time elapsed between the last mammography and the cancer diagnosis (less than 12 months), the more tumors with little or no affected lymph node and tumors without distant metastases were found. Nevertheless, none of the analyses has statistical significance ( $p>0.05$ ).

Table 3 shows the correlation between TNM staging and the frequency of mammography screening. When analyzing the extension of the primary tumor, it was verified that mammography with annual frequency is associated with tumors of lesser extent ( $p=0.041$ ). When associating the screening frequency and lymph node involvement with the presence of distant metastases, there was no statistical significance ( $p>0.05$ ).

Correlation between the frequency of mammography screening and the therapy adopted for each patient is demonstrated in Table 4. Study participants were asked about the frequency for performing the examination, and this datum was crossed with the treatments and interventions that each patient underwent such as breast surgery, axillary surgery, and the adopted chemotherapy intervention. Such analyses, described in Table 4, had no statistical significance.

The time elapsed between the last mammography screening and the diagnosis of breast cancer was also correlated with the chosen therapeutic approach. Among the 49 patients who had undergone the examination less than 12 months ago, 77.6% (38/49) underwent breast-conserving surgery; 22.4% (11/49), mastectomy; 63.3% (31/49), sentinel lymph node biopsy; 28.6% (14/49), axillary dissection; and 8.2% (4/49), no axillary approach.

Among the 17 patients whose elapsed time from the last mammography was between 12 and 24 months, 70.6% (12/17) underwent breast-conserving surgery and 29.4% (5/17) required

**Table 1.** Clinical-epidemiological profile of the sample.

	n (%)
	n=99
Age (years)	
40–49	38 (38.4)
50–59	26 (26.3)
60–69	21 (21.2)
≥70	14 (14.1)
Skin color	
White	94 (94.9)
Black	4 (4.0)
Other	1 (1.0)
Menopausal status	
Premenopausal	28 (28.3)
Postmenopausal	71 (71.7)
Primary tumor extension (T)	
T1	59 (59.6)
T2	28 (28.3)
T3	8 (8.1)
T4	4 (4.0)
Lymph nodes affected by metastasis (N)	
N0	65 (65.7)
N1	25 (25.3)
N2	6 (6.1)
N3	3 (3.0)
Distant metastasis (M)	
M0	96 (97.0)
M1	3 (3.0)
Positive estrogen receptor	83 (83.8)
Positive progesterone receptor	73 (73.7)
Positive HER2	11 (11.1)
Ki67	
Lower than 14%	64 (64.6)
Higher than or equal to 14%	35 (35.4)

HER2: human epidermal growth factor receptor 2.

mastectomy. Regarding axillary surgery, 64.7% (11/17) underwent sentinel lymph node biopsy, and 35.3% (6/17) underwent axillary dissection.

When analyzing the 33 patients whose elapsed time of the last examination and the diagnosis was over 24 months, it was noted that 72.7% (24/33) underwent breast-conserving surgery; 27.3%, mastectomy; 78.8% (26/33), sentinel lymph node biopsy; and 21.2% (7/33), axillary dissection. However, no statistical significance was found in such analyses.

In Table 5, the relationship between the immunohistochemical profile of the tumors (with regard to the expression of estrogen receptor, progesterone receptor, expression or amplification of human epidermal growth factor receptor 2 – HER2 –, and Ki67) and chemotherapy was analyzed, whether the chemotherapy was adjuvant, neoadjuvant, or not performed. When observing this table, it is noteworthy that most patients who underwent chemotherapy had positive hormone receptors, especially when the progesterone receptor was verified, with statistical significance

**Table 2.** Correlation between tumor staging and time elapsed between the last mammography and the diagnosis of breast cancer.

	Time between last mammography and diagnosis n (%)			p-value*
	More than 24 months	Between 12 and 24 months	Less than 12 months	
Primary tumor extension (T)	n=33	n=17	n=49	0.026
T1	17 (51.5)	13 (76.5)	29 (59.2)	
T2	13 (39.4)	3 (17.6)	12 (24.5)	
T3	0 (0.0)	1 (5.9)	7 (14.3)	
T4	3 (9.1)	0 (0.0)	1 (2.0)	
Lymph nodes affected by metastasis (N)				0.873
N0	22 (66.7)	11 (64.7)	32 (65.3)	
N1	9 (27.3)	5 (29.4)	11 (22.4)	
N2	1 (3.0)	1 (5.9)	4 (8.2)	
N3	1 (3.0)	0 (0.0)	2 (4.0)	
Distant metastasis (M)				0.545
M0	32 (97.0)	17 (100.0)	47 (95.9)	
M1	1 (3.0)	0 (0.0)	2 (4.1)	

\*Value obtained after applying the likelihood ratio test.

**Table 3.** Correlation between tumor staging and frequency of mammography screening.

	Frequency of mammography, n (%)				p-value*
	Annually	Biannually	Undefined frequency	Had never done it	
Primary tumor extension (T)	n=58	n=3	n=20	n=18	0.041
T1	36 (62.1)	3 (100.0)	12 (60.0)	8 (44.4)	
T2	15 (25.9)	0 (0.0)	6 (30.0)	7 (38.9)	
T3	7 (12.1) <sup>b</sup>	0 (0.0)	1 (5.0)	0 (0.0)	
T4	0 (0.0)	0 (0.0)	1 (5.0)	3 (16.7)	
Lymph nodes affected by metastasis (N)					0.591
N0	37 (63.8)	2 (66.7)	14 (70.0)	12 (66.7)	
N1	15 (25.9)	1 (33.3)	4 (20.0)	5 (27.8)	
N2	5 (8.6)	0 (0.0)	0 (0.0)	1 (5.6)	
N3	1 (1.7)	0 (0.0)	2 (10.0)	0 (0.0)	
Distant metastasis (M)					0.623
M0	56 (96.6)	3 (100.0)	20 (100.0)	17 (94.4)	
M1	2 (3.4)	0 (0.0)	0 (0.0)	1 (5.6)	

<sup>b</sup>Statistically significant values after analysis of residuals ( $p < 0.05$ ); \*value obtained after applying the likelihood ratio test.

( $p < 0.001$ ), negative HER2, and a cell proliferation marker lower than or equal to 14%, characterizing tumors of the luminal subtype.

Furthermore, the relationship between TNM staging and the adopted therapeutic approach was analyzed. Patients were divided between 74, who underwent breast-conserving surgery, and 25, who underwent mastectomy. When correlating the extension of the primary tumor and the type of breast surgery adopted, it was verified that, among patients who underwent conservative surgical treatment, in 67.6% (50/74) of the cases the tumors were T1; in 28.4% (21/74), T2; in 2.7% (2/74), T3; and in 1.4% (1/74), T4.

Conversely, when observing patients who underwent mastectomy, in 36% (9/25) of them the tumors were T1; in 28% (7/25), T2; in 24% (6/25), T3; and in 12% (3/25), T4. Thus, it was noted that the more initial the tumor staging, the more conservative breast surgery was chosen as the adopted therapy, obtaining statistical significance ( $p < 0.001$ ). The same was observed for lymph nodes affected by metastasis. It was found that, among patients who underwent conservative surgery, 77% (57/74) had N0 tumors; 17.6% (13/74), N1 tumors; 2.7% (2/74), N2 tumors; and 2.7% (2/74), N3 tumors.

When analyzing the patients who underwent mastectomy, 32% (8/25) had N0 tumors; 48% (12/25), N1 tumors; 16% (4/25),

**Table 4.** Correlation between the frequency of mammography screening and the chosen therapeutic approach.

	Frequency of mammography, n (%)				p-value*
	Annually	Biannually	Undefined frequency	Had never done it	
	n=58	n=3	n=20	n=18	
<b>Breast-conserving</b>					
Surgery	42 (72.4)	3 (100.0)	17 (85.0)	12 (66.7)	0.291
Mastectomy	16 (27.6)	0 (0.0)	3 (15.0)	6 (33.3)	
<b>Axillary surgery</b>					
Sentinel lymph node	35 (60.3)	2 (66.7)	17 (85.0)	14 (77.8)	0.241
Axillary dissection	19 (32.8)	1 (33.3)	3 (15.0)	4 (22.2)	
No	4 (6.9)	0 (0.0)	0 (0.0)	0 (0.0)	
<b>Adjuvant</b>					
Chemotherapy	18 (31.0)	2 (66.7)	7 (35.0)	7 (38.9)	0.577
Neoadjuvant	21 (36.2)	0 (0.0)	5 (25.0)	7 (38.9)	
No	19 (32.8)	1 (33.3)	8 (40.0)	4 (22.2)	

\*Value obtained after applying the likelihood ratio test.

**Table 5.** Relationship between immunohistochemical profile of the tumor and chemotherapy.

	Chemotherapy n (%)			p-value
	Neoadjuvant	chemotherapy	No	
<b>Estrogen receptor</b>				
	n=34	n=33	n=32	
Positive	29 (85.3)	24 (72.7)	30 (93.8)	0.068*
Negative	5 (14.7)	9 (27.3)	2 (6.3)	
<b>Progesterone receptor</b>				
Positive	27 (79.4)	16 (48.5)	30 (93.8)	<0.001*
Negative	7 (20.6)	17 (51.5)*	2 (6.3)	
<b>HER2</b>				
Positive	3 (8.8)	7 (21.2)	1 (3.1)	0.056*
Negative	31 (91.2)	26 (78.8)	31 (96.9)	
<b>Ki67</b>				
Lower than or equal to 14%	23 (67.6)	20 (60.6)	21 (65.6)	0.826*
Higher than 14%	11 (32.4)	13 (39.4)	11 (34.4)	

\*Values obtained after applying the Fisher's exact test; \*\*value obtained after applying the Pearson's  $\chi^2$  test; HER2: human epidermal growth factor receptor 2.



N2 tumors; and 4% (1/25), N3 tumors. That is, when having no involvement or the lesser the involvement of the tumors, the more breast-conserving surgery was adopted ( $p < 0.001$ ).

When correlating the presence or absence of distant metastases and the diagnosis with the breast surgery chosen, breast-conserving surgery was preferred in the cases of absence of metastases. However, these data are not statistically significant ( $p = 0.156$ ).

Still on the relationship between the TNM staging and the adopted therapeutic approach, when the tumor staging was associated with the type of axillary surgery, of the 68 patients who underwent sentinel lymph node biopsy, 66.2% (45/68) were classified as T1; 23.5% (16/68), T2; 5.9% (4/68), T3; and 4.4% (3/68), T4.

As for lymph nodes affected by metastasis, 79.4% (54/68) had N0 tumors; 17.6% (12/68), N1 tumors; 1.5% (1/68), N2 tumors; and 1.5% (1/68), N3 tumors. Concerning distant metastases, 97.1% (66/68) had no evidence of metastasis, being classified as M0, and 2.9% (2/68) were classified as M1.

Among the 27 patients who underwent axillary dissection, with regard to the extension of the primary tumor, 40.7% (11/27) were classified as T1; 40.7% (11/27), T2; 14.8% (4/27), T3; and 3.7% (1/27), T4. As for the affected lymph nodes, 25.9% (7/27) of the patients had N0 tumors; 48.1% (13/27), N1 tumors; 18.5% (5/27), N2 tumors; and 7.4% (2/27), N3 tumors.

Considering distant metastases, 96.3% (26/27) were classified as M0, and 3.7% (1/27) as M1. When analyzing the four patients who did not undergo any axillary surgical approach, 75% (3/4) were classified as T1, and 25% (1/4) as T2. Regarding the affected lymph nodes, 100% patients were classified as N0 and, in relation to distant metastases, 100% had M0 tumors. The correlation between the affected lymph nodes and the type of axillary surgery was statistically significant, with  $p < 0.001$ .

The correlation between TNM staging at the time of diagnosis and whether the patients undergone chemotherapy (adjuvant or neoadjuvant) or not was also analyzed. Among the evaluated patients, 34 underwent adjuvant chemotherapy; 33, neoadjuvant chemotherapy; and 32 did not undergo chemotherapy.

Among patients who underwent adjuvant chemotherapy, and according to the extension of the primary tumor, in 55.9% (19/34) of the cases the tumors were T1; in 41.2% (14/34), T2; in 2.9% (1/34), T3; and none of them met the criteria for the T4 classification. Among these same patients and by analyzing the lymph nodes affected by metastasis, in 67.6% (23/34) of the cases the tumors were N0; in 23.5% (8/34), N1; in 2.9% (1/34), N2; and in 5.9% (2/34), N3.

As for patients who underwent neoadjuvant chemotherapy and according to the extension of the primary tumor, 36.4% (12/33) of the cases had T1 tumors; 30.3% (10/33), T2; 21.2% (7/33), T3; and 12.1% (4/33), T4. When lymph nodes affected by metastasis were examined in these same patients, in 39.4% (13/33) the tumors were N0; in 42.4% (14/33), N1; in 15.2% (5/33), N2; and in 3% (1/33), N3.

Among patients who did not undergo chemotherapy and by analyzing the extension of the primary tumor, 87.5% (28/32) had T1 tumors; 12.5% (4/32), T2; and none of them presented T3 or T4 tumors. Likewise, when analyzing lymph nodes affected by metastasis, 90.6% (29/32) of the patients had N0 tumors, and 9.4% (3/32) had N1 tumors. That is, none had N2 or N3 tumors. Such data crossings obtained statistical significance, with  $p < 0.001$ .

This analysis does not include the evaluation of distant metastases considering that, when present, the adopted approach involves palliative therapy, no longer with curative purposes.

## DISCUSSION

The present study evaluated the influence of mammographic screening on the treatment of women with previous diagnosis of breast cancer.

Regarding the clinical-epidemiological profile of patients and by evaluating the global statistics on the prevalence of breast cancer, the incidence of this type of neoplasia progressively increases from the age of 40<sup>2</sup>, in line with what was observed in this study, in which most patients, 38.4% (38/99), aged between 40 and 49 years and 26.3% (26/99), between 50 and 59 years. The result is similar to that found in a Brazilian study that states that, in developing countries, the incidence of breast cancer in women aged between 40 and 50 years is higher than in developed countries<sup>12</sup>.

Corroborating such information, in the present study, 71.7% (71/99) of the patients obtained the diagnosis already in the postmenopausal stage, and, of the observed population, 94.9% (94/99) were white. Similar characteristics were found in the study conducted by Miglioretti et al., who obtained a sample of 15,440 women with breast cancer, in which the majority were 50 years old or older (85.4%), white (78.1%), and were in the postmenopausal stage (63.6%)<sup>13</sup>.

When evaluating the patients' performance of mammography, the present study showed that most of them, 58.6% (58/99), annually underwent the examination, against 20.2% (20/99) who had undefined frequency, 3% (3/99) who biannually performed it, and 18.2% (18/99) who had never done it. Similar results are reported in the study of Ribeiro et al., in which 53% of the evaluated patients had an annual screening frequency; 12.5%, biannual; 23%, irregular; and 8.5% had never been screened<sup>14</sup>.

The fact that both studies show that most patients underwent annual screening is extremely important, considering that mammography is the most reliable and reproducible secondary prevention method for detecting breast cancer. When performed with certified equipment, by qualified technicians, and with the interpretation of experienced radiologists, the accuracy rate of 85% to 90% can be achieved for the identification of nonpalpable preclinical tumors<sup>15</sup>.

In this study, when assessing the time elapsed between the last mammography before the diagnosis of breast cancer and the diagnosis, it was observed that 49.5% (49/99) of the participants had done the examination less than 12 months ago; in 17.2% (17/99) of the cases, between 12 and 24 months; and in 33.3% (33/99), for more than 24 months. Similar data were found in the study conducted by Ahn et al., in which, among the 1,125 analyzed patients, 73% had been screened 24 months before diagnosis and 27% had been screened over 25 months ago<sup>6</sup>.

Regarding TNM staging, in the present study, there was a higher frequency of stage I breast cancer, that is, tumors of 2 centimeters or less, without lymph node involvement, and absence of metastases<sup>16</sup>. The higher frequency of tumors in early stages may justify the fact that most patients in this study underwent breast-conserving surgeries (74.7%) and sentinel lymph node biopsy (68.7%) rather than more aggressive therapeutic methods.

Corroborating this finding, in the study conducted by Ribeiro et al., based on database of the Núcleo de Mama de Porto Alegre, Núcleo de Mama Moinhos, and Hospital de Clínicas de Porto Alegre, among patients who were classified as stage I, 73% underwent breast-conserving surgeries<sup>14</sup>. This can be justified by the study of Barth et al., who observed that breast cancers detected by mammography are of lesser extent, less likely to metastasize to the lymph nodes and, thus, more likely to be treated with breast-conserving surgery<sup>8</sup>.

When assessing the adopted treatment and its relationship with mammography screening, the present study showed that patients who underwent mammography biannually or more frequently had outcomes of surgical interventions and chemotherapy treatment similar to those of women who underwent mammography without defined frequency or who had never done it. This result is also evidenced by the study of Ahn et al., who demonstrated less invasive therapeutic interventions in patients who underwent mammography with a biennial frequency<sup>6</sup>, although in the present study the absolute majority of patients had undergone less invasive treatments.

The study conducted by McDonald et al. concluded that the treatment must integrate the analysis of immunohistochemical markers and gene expression with information on anatomical margins and imaging studies, in order to individualize the treatment plan and the response to treatment<sup>17</sup>. This conclusion somewhat justifies what was found in the present study, in which the therapeutic modalities, both surgical and chemotherapeutic, proved to be similar among patients. Thus, the similarity in therapeutic approaches can be explained based on the molecular subtypes verified and on the performance of neoadjuvant therapies, and not only on the fact that surgical techniques tend to be less aggressive nowadays.

That is why gene expression has become an essential finding in understanding the biology of cancer, considering that

each molecular subtype has significant differences in terms of incidence, risk factors, sensitivity to treatment, and prognosis<sup>18</sup>.

In this study, among patients who had done their last mammography prior to diagnosis less than 12 months ago, 8.2% (4/49) did not require an axillary surgical approach and 63.3% (31/49) only underwent sentinel lymph node biopsy, thus corroborating studies whose authors state that low-grade tumors at diagnosis result in less lymph node involvement, requiring less interventions, as shown by the study of Warriar et al.<sup>19</sup>. Therefore, less extensive treatments are expected in patients undergoing screening, as endorsed by Brazilian recommendations<sup>20</sup>, considering the well-known relationship between mammography screening and less lymph node involvement at diagnosis.

Surgical and chemotherapy outcomes were similar among patients with annual or biennial frequency of mammography screening and those who underwent mammography without a defined frequency or who had never done it; this probably occurred because, nowadays, regarding surgical treatment, breast-conserving surgery is preferred to mastectomy, followed by adjuvant radiotherapy, as well as sentinel lymph node biopsy, which have been chosen as treatments rather than axillary dissection for presenting less iatrogenesis and equivalent survival rates<sup>18,21</sup>.

Furthermore, this outcome may be corroborated by the fact that most patients are younger (40–49 years of age), an age group in which there is disagreement in the Brazilian Ministry of Health concerning mammography screening, as the department is against screening for women under 50 years of age<sup>20</sup>, and also because most tumors present in the current study are of the luminal subtype, i.e., less aggressive and of slower growth<sup>22</sup>. This evidences that multiple prognostic factors must be taken into account when considering the ideal therapeutic modality that the patient will undergo, especially when it comes to molecular analysis and biological behavior of the tumor.

In a recent study conducted by Duffy et al., aiming at estimating the influence of annual mammography screening before the age of 50, the authors observed that the reduction of the age limit for undergoing the screening, from 50 to 40 years, could potentially decrease mortality from such cancer<sup>23</sup>. This fact justifies the findings of the present study, in which the absolute majority of analyzed women underwent mammography on an annual basis and were younger, i.e., aged between 40 and 49 years, an age group to which screening is not recommended according to national guidelines. However, such patients had tumors of lesser extent at diagnosis, with more conservative therapeutic modalities and higher survival rates.

As limitations of the present study, there is lack of information in the patients' medical records, causing the sample to be reduced. All participating patients underwent treatment subsidized by the Brazilian Unified Health System, and there may be financial limitations to such treatment.

## CONCLUSION

It was observed that, in patients who annually underwent mammography and those whose elapsed time between the last mammography and the diagnosis of cancer was less than 12 months, at the time of diagnosis the tumors were of lesser extent, without, however, influencing the type of therapy adopted for treatment, considering that the absolute majority of evaluated patients were treated with less invasive therapeutic methods.

Therapeutic modalities were similar between the groups, even if differently performing the screening or not performing it, and this may be due to the fact that the absolute majority of patients had tumors of the luminal subtype, i.e., less aggressive, of slower growth, and that had positive hormone receptors, making it possible, in many cases, to undergo neoadjuvant chemotherapy.

This strategy has been increasingly frequent in the management of breast cancer, becoming an alternative even for tumors of greater extent, primarily treated by systemic therapy and, later, with less extensive surgical approaches. Another strategy is the acknowledged

tendency to prefer breast-conserving surgeries and sentinel lymph node biopsy to more extensive surgeries, considering that these procedures present less iatrogenesis and equivalent survival rates.

New studies that highlight, in the long term, the impact of mammography on mortality, in addition to the morbidity related to the most diverse therapeutic methods available, considering the heterogeneity of this type of cancer, would be relevant to clinical updates.

## AUTHORS' CONTRIBUTIONS

L.U.: Conceptualization, data collection and analysis, methodology, project management, writing, supervision, validation, review and editing.

L.C.: Conceptualization, data collection and analysis, methodology, project management, writing, supervision, validation, review and editing.

A.R.: Conceptualization, project management, supervision and review.

## REFERENCES

1. Lukong KE, Ogunbolude Y, Kamdem JP. Breast cancer in Africa: prevalence, treatment options, herbal medicines, and socioeconomic determinants. *Breast Cancer Res Treat.* 2017;166(2):351-65. Breast cancer in Africa: prevalence, treatment options, herbal medicines, and socioeconomic determinants. *Breast Cancer Res Treat.*
2. Instituto Nacional de Câncer Jose Alencar Gomes da Silva. Programa Controle de Câncer de Mama [Internet]. Brazil: INCA; 2018 [accessed on Oct. 27, 2018]. Available from: <https://www.inca.gov.br/tipos-de-cancer/cancer-de-mama/profissional-de-saude>
3. Instituto Nacional de Câncer Jose Alencar Gomes da Silva. Estimativa 2018: Incidência de Câncer no Brasil [Internet]. Rio de Janeiro: Ministério da Saúde; 2018 [accessed on Oct. 16, 2018]. Available from: <http://www.epi.uff.br/wp-content/uploads/2013/08/estimativa-incidencia-de-cancer-no-brasil-2018.pdf>
4. Yeo SK, Guan JL. Breast cancer: multiple subtypes within a tumor? *Trends Cancer.* 2017; 3(11):753-60. <https://doi.org/10.1016/j.trecan.2017.09.001>
5. Vuong D, Simpson PT, Green B, Cummings MC, Lakhani SR. Molecular classification of breast cancer. *Virchows Arch.* 2014;465(1):1-14. <https://doi.org/10.1007/s00428-014-1593-7>
6. Ahn S, Wooster M, Valente C, Moshier E, Meng R, Pisapati K, et al. Impact of screening mammography on treatment in women diagnosed with breast cancer. *Ann Surg Oncol.* 2018;25(10):2979-86. <https://doi.org/10.1245/s10434-018-6646-8>
7. Lebron-Zapata L, Jochelson MS. Overview of Breast Cancer Screening and Diagnosis. *PET Clin.* 2018;13(3):301-23. <https://doi.org/10.1016/j.cpet.2018.02.001>
8. Barth Jr. RJ, Gibson GR, Carney PA, Mott LA, Becher RD, Poplack SP. Detection of breast cancer on screening mammography allows patients to be treated with less-toxic therapy. *AJR Am J Roentgenol.* 2005;184(1):324-9. <https://doi.org/10.2214/ajr.184.1.01840324>
9. Merino Bonilla JA, Torres Tabanera M, Ros Mendoza LH. El cáncer de mama en el siglo XXI: de la detección precoz a los nuevos tratamientos. *Radiología.* 2017;59(5):368-79. <https://doi.org/10.1016/j.rx.2017.06.003>
10. Sarosiek T. Systemic treatment of early breast cancer – current state of knowledge after the conference St Gallen 2017. *Pol Merkur Lekarski.* 2017;43(257):232-6.
11. Matsen CB, Neumayer LA. Breast Cancer: a review for the general surgery. *JAMA Surg.* 2013;148(10):971-9. <https://doi.org/10.1001/jamasurg.2013.3393>
12. Urban LABD, Schaefer MB, Duarte DL, Santos RP, Maranhão NMA, Kefalas AL, et al. Recomendações do Colégio Brasileiro de Radiologia e Diagnóstico por Imagem, da Sociedade Brasileira de Mastologia e da Federação Brasileira das Associações de Ginecologia e Obstetrícia para rastreamento do câncer de mama por métodos de imagem. *Radiol Bras.* 2012;45(6):334-9. <https://doi.org/10.1590/S0100-39842012000600009>
13. Miglioretti DL, Zhu W, Kerlikowske K, Sprague BL, Onega T, Buist DSM, et al. Breast Tumor Prognostic Characteristics and Biennial vs Annual Mammography, Age, 549 and Menopausal Status. *JAMA Oncol.* 2015;1(8):1069-77. <https://doi.org/10.1001/jamaoncol.2015.3084>
14. Ribeiro RA, Caleffi M, Polanczyk CA. Custo-efetividade de um programa de rastreamento organizado de câncer de mama no Sul do Brasil. *Cad Saúde Pública.* 2013;29(Suppl. 1):s131-s145. <https://doi.org/10.1590/0102-311X00005213>

15. Coleman C. Early Detection and Screening for Breast Cancer. *Semin Oncol Nurs.* 2017;33(2):141-55. <https://doi.org/10.1016/j.soncn.2017.02.009>
16. American Cancer Society. Breast cancer stages [Internet]. American Cancer Society; 2017 [accessed on Nov. 14, 2018]. Available from: <https://www.cancer.org/cancer/breast-cancer/understanding-a-breast-cancer-diagnosis/stages-of-breast-cancer.html>
17. McDonald ES, Clark AS, Tchou J, Zhang P, Freedman GM. Clinical diagnosis and management of breast cancer. *J Nucl Med.* 2016;57(Suppl. 1):9S-16S. <https://doi.org/10.2967/jnumed.115.157834>
18. Veronesi U, Galimberti V, Mariani L, Gatti G, Paganelli G, Viale G, et al. Sentinel node biopsy in breast cancer: early results in 953 patients with negative sentinel node biopsy and no axillary dissection. *Eur J Cancer.* 2005;41(2):231-7. <https://doi.org/10.1016/j.ejca.2004.05.009>
19. Warriar S, Tapia G, Goltsman D, Beith J. An update in breast cancer screening and management. *Womens Health (Lond).* 2016;12(2):229-39. <https://doi.org/10.2217/whe.15.105>
20. Migowski A, Silva GAE, Dias MBK, Diz MDPE, Sant'Ana DR, Nadanovsky P. Guidelines for early detection of breast cancer in Brazil. II - new national recommendations, main evidence, and controversies. *Cad Saúde Pública.* 2018;34(6):e00074817. <http://dx.doi.org/10.1590/0102-311x00074817>
21. Clarke M, Collins R, Darby S, Davies C, Elphinstone P, Evans V, et al. Effects of radiotherapy and of differences in the extent of surgery for early breast cancer on local recurrence and 15- year survival: an overview of the randomised trials. *Lancet.* 2005;366(9503):2087-106. [https://doi.org/10.1016/s0140-6736\(05\)67887-7](https://doi.org/10.1016/s0140-6736(05)67887-7)
22. Prat A, Pineda E, Adamo B, Galván P, Fernández A, Gaba L, et al. Clinical implications of the intrinsic molecular subtypes of breast cancer. *Breast.* 2015;24(Suppl. 2):S26-S35. <https://doi.org/10.1016/j.breast.2015.07.008>
23. Duffy SW, Vulkan D, Cuckle H, Parmar D, Sheikh S, Smith RA, et al. Effect of mammographic screening from age 40 years on breast cancer mortality (UK Age trial): final results of a randomised, controlled trial. *Lancet Oncol.* 2020;21(9):1165-72. [https://doi.org/10.1016/S1470-2045\(20\)30398-3](https://doi.org/10.1016/S1470-2045(20)30398-3)



# Impact of the COVID-19 pandemic on breast cancer diagnosis

Cícera Chaves Lôbo<sup>1\*</sup>, Luiz Gonzaga Porto Pinheiro<sup>2</sup>, Paulo Henrique Diógenes Vasques<sup>3</sup>

## ABSTRACT

**Introduction:** In 2020, a total of 2,510 new cases of breast cancer were estimated in Ceará State, 14% above the figures of 2019. In the context of the COVID-19 pandemic, postponing screening and assessing the risks and benefits of elective procedures was needed, rescheduled until after their control. **Objective:** We sought to identify the impact of the COVID-19 pandemic in the care of a Reference Service for Breast Cancer Diagnosis. **Methods:** Time series study, with analysis of the production of the consultations carried out from March to June of the current year in a service located in Fortaleza City, Ceará State. **Results:** There was a reduction of up to 84% in the services offered, with emphasis on mammography and ultrasound procedures, with 95 and 100%, respectively. The diagnosis of new cases and the performance of surgeries reduced by up to 60 and 56%, respectively. The months with the greatest impact were April and May, with a progressive resumption in June. **Conclusion:** The study evaluated a reference service of relevance in the state reality. Considering that many cases are identified during screening, postponing mammograms contributed to a delayed diagnosis. The findings are believed to pose severe consequences, considering the annual increase in the incidence of the disease, the low screening coverage, the high number of cases in advanced staging, the ascending mortality, and the low supply of diagnostic services. Diverting attention exclusively to the pandemic represents a worldwide challenge, but cancer is an important cause of morbidity and mortality, and cannot be neglected. There is concern that delaying screening, diagnosis, and treatment of breast cancer may cost more lives than COVID-19 itself. Post-pandemic requires planning to promote harm reduction resulting from the delay in the diagnosis and treatment of the repressed demand, in a disaggregated and overloaded system.

**KEYWORDS:** breast neoplasms; health services; early detection of cancer; mass screening; coronavirus infection.

## INTRODUCTION

Global cancer estimates were 18.1 million new cases and 9.6 million cancer deaths in 2018. Breast cancer is recognized as the most prevalent type in the female population worldwide, except in East Africa, with 2,088,049 new cases. It represents 24.2% of the total number of cancer cases in women, with a 15.0% mortality rate and an upward estimate of 3,059,829 cases in 2040.<sup>1</sup>

For 2020, approximately 625,000 cancer diagnoses were forecast in Brazil. Except for non-melanoma skin tumors, breast cancer is the most common type in the female population, with 66,280 new cases, 29.7% of the total cases, and an estimated risk

of 61.61 cases per 100,000 women. In Ceará State, the estimate is 2,510 new cases, with approximately half of the cases in the capital. These national figures are roughly 10% higher than the previous estimate, and being above 50 is considered the most significant risk factor. The estimated increase for the state is approximately 14%.<sup>2,3</sup>

Such data are like those of high-income countries, such as the United States, in which cancer also represents 30% of all new cases. But unlike those countries, in which mortality has declined in recent decades, Brazilian mortality rates still show an upward curve.<sup>3,4</sup> Late diagnosis predominates in

<sup>1</sup>Hospital Universitário Walter Cantídio, Universidade Federal do Ceará – Fortaleza (CE), Brazil.

<sup>2</sup>Universidade Federal do Ceará – Fortaleza (CE), Brazil.

<sup>3</sup>Secretaria Municipal da Saúde – Fortaleza (CE), Brazil.

\*Corresponding author: [ciceralobo@bol.com.br](mailto:ciceralobo@bol.com.br)

Conflict of interests: nothing to declare.

Received on: 09/09/2020. Accepted on: 09/27/2020

80% of cases, to the detriment of 40% in the American population.<sup>5</sup> Another divergence is the high percentage of diagnoses in young women in the Brazilian population, outside the screening target.<sup>6</sup>

Coronavirus disease 2019 (COVID-19), caused by SARS-CoV-2, which first appeared in December 2019 in Wuhan, China, was declared as a pandemic by the World Health Organization (WHO) on March 11<sup>th</sup>, 2020. It imposed urgent and aggressive measures by worldwide national health services for the threat posed by this virus, which is highly infectious and has the potential to evolve into serious and fatal conditions, especially in older adults, immunosuppressed people, and patients with some chronic diseases. Some recommendations are promoting social distancing, detecting cases, tracking contacts, testing and treating patients in a timely manner.<sup>7</sup>

Guided by WHO recommendations, the National Cancer Institute (INCA) issued a technical note recommending that professionals advise people not to seek health services for screening mammograms, thus postponing consultations and exams until restrictions are reduced.<sup>8</sup> The imposed measures led many patients to a temporary gap in care, considering the status of the case (risk of death), made by the team, and should be documented in the medical record.<sup>9</sup> This recommendation is in line with that recommended in the rest of the world.<sup>10-12</sup>

Some preliminary recommendations were postponing or continuing cancer treatment during the pandemic, based mainly on the categorization of patients at low, moderate, or high risk of disease progression without antineoplastic treatment. For some extremely aggressive tumor types, timely diagnosis and treatment is required. For others, including breast cancer, the delay in therapeutic interventions can be considered, based on the status of each case. This change may not affect the outcome in the long run, whereas potential exposure to the virus can be risky or even fatal. These recommendations can be applied with caution in current clinical practice until evidence-based guidelines are available. However, postponing breast cancer screening, diagnosis, and treatment is likely to cost more patients' lives than COVID-19 itself.<sup>10,11,13</sup>

At a time when knowledge and information emerge almost concomitantly, we sought to identify the impact of the COVID-19 pandemic in the care of a Reference Service for Breast Cancer Diagnosis.

## METHODS

This is a trend analysis, or time series, carried out in July 2020 in an SDM located in the city of Fortaleza City, Ceará State. It was chosen for its role in the diagnosis and treatment of breast cancer since the early 2000s, becoming the first SDM within Ceará State in 2016. The efforts made since then have multiplied over the following years, consolidating their impact on the state network of the Brazilian Unified Health System (*Sistema Único de*

*Saúde* - SUS). Currently, the service provides specialized medical consultation, mammography, breast ultrasound, breast puncture (with core biopsy and fine needle), breast biopsy (in the open, guided by mammography and ultrasound), and nodule excision. The result of these efforts culminates in 8% of the diagnoses of Ceará's territory in a single service in the historical series of recent years.

Data were collected on the production of consultations carried out from March to June 2020, arranged in the database of the Outpatient Information System (*Sistema de Informação Ambulatorial* - SIA/SUS), the Hospital Information System (*Sistema de Informações Hospitalares* - SIH/SUS), and the Integrator of the Hospital Cancer Registry (*Integrador do Registro Hospitalar de Câncer* - RHC). There was univariate statistical analysis, with calculation of the average number of visits, diagnostic procedures, new cases and surgeries (mastectomies/quadrantectomies) in the previous year, 2019, and comparison with production during the pandemic period. Ethical aspects were respected for collection in open databases.

## RESULTS

Considering the year of 2019 as a reference, the average number of visits was 1,411 per month, namely: specialized medical consultation, mammography, breast ultrasound, breast puncture (with core biopsy and fine needle), breast biopsy (in the open, guided by mammography and ultrasound), and nodule excision. The most frequent procedure is mammography, with an average of 781 per month. Breast cancer presents a monthly average of 15 new cases and performs an average of 18 surgeries (mastectomies).

After the COVID-19 pandemic started, March suffered a small impact, remaining on average, but there was an abrupt reduction in April, reaching a decrease of 84% in May, as shown

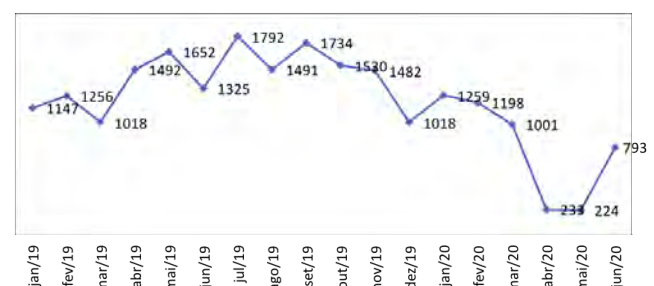

Source: Outpatient Information System (*Sistema de Informação Ambulatorial* - SIA/SUS).

**Graph 1.** Services provided in Reference Service for Breast Cancer Diagnosis (*Serviço de Referência para Diagnóstico de Câncer de Mama* – SDM) of the Oncology Education and Studies Group (*Grupo de Educação e Estudos Oncológicos* – GEEON) from January 2019 to June 2020, Fortaleza City – Ceará State, July 2020.

in Graph 1. In mid-June, with stabilization in cases and mortality, care gradually resumed, totaling 44% of the monthly average in June.

The most frequent procedures were mammography and specialized medical consultation. However, mammography and breast ultrasound presented the greatest impact resulting from the pandemic, with a reduction of 95 and 100%, respectively, as shown in Graph 2.

At first, the result of reduction in visits had a slight impact on the number of new cases diagnosed and surgical procedures, keeping them at the historical average. After the second month, there was a reduction of 60 and 56%, respectively, as shown in Graph 3.

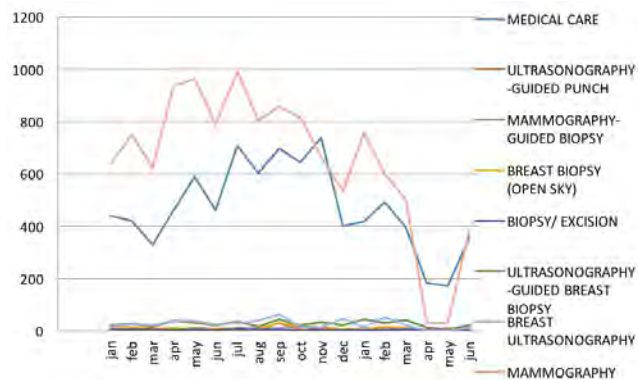

Source: Outpatient Information System (*Sistema de Informação Ambulatorial - SIA/SUS*).

**Graph 2.** Procedures performed in Reference Service for Breast Cancer Diagnosis (Oncology Education and Studies Group (*Grupo de Educação e Estudos Oncológicos – GEEON*) from January/ 2019 to June/2020, Fortaleza City, Ceará State, July/2020.

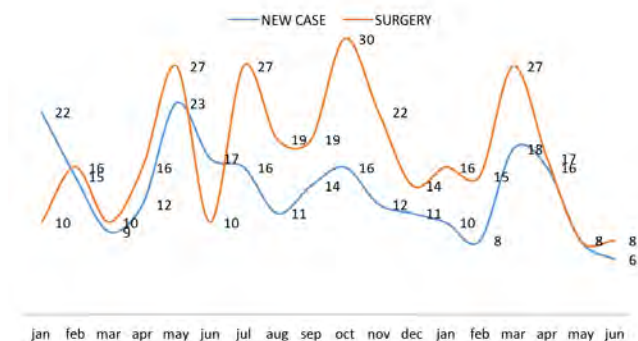

Source: Hospital Information System (*Sistema de Informações Hospitalares - SIH/SUS*) and Integrator of the Hospital Cancer Registry (*Integrador do Registro Hospitalar de Câncer - RHC*).

**Graph 3.** New cases of breast cancer and procedures performed in Reference Service for Breast Cancer Diagnosis (*Serviço de Referência para Diagnóstico de Câncer de Mama – SDM*) of the Oncology Education and Studies Group (*Grupo de Educação e Estudos Oncológicos – GEEON*) from January/ 2019 to June/2020, Fortaleza City, Ceará State, July/2020.

## DISCUSSION

The best way to conduct care in early diagnosis and in the screening of breast cancer during the pandemic is uncertain, but the guidelines recommend changing our practice, which makes it difficult not to succumb to the distracting effect in the provision of care.<sup>8,13-15</sup>

Population aging has increased the overall incidence of cancer. In emerging countries, there is an epidemiological transition, a phase in which the most common types are no longer predominantly associated with inflammatory and infectious causes and are now caused by harmful lifestyles. In low and middle-income countries, late diagnosis predominates.<sup>16</sup>

Despite efforts, there will be more challenges in the future as a result of changes in standard practice after society has recovered from the COVID-19 pandemic.<sup>12,14,17</sup> For now, focus should be placed on the immediacy of protecting cancer patients in the best possible way.<sup>9</sup>

The current COVID-19 pandemic is unprecedented, and its numbers continue increasing, but the world is preparing for a gradual resumption, including in healthcare services, limiting patient exposure. These changes will inevitably have adverse consequences in the breast cancer diagnosis, in the treatment and in the survival of patients.<sup>10-12</sup>

Before the COVID-19 pandemic, the estimate of new cases of breast cancer for 2020 already presented a challenging scenario for health managers, considering that, year after year, morbidity and mortality figures show an upward curve, despite the implementation of health equipment and efforts to expand access to the network. The increase of approximately 14% in new cases compared to the 2018–2019 biennium, added to most diagnoses with advanced stage, reflects the severity of the condition and the absence of an effective public policy capable of controlling the disease, which increasingly affects women at ages outside the tracking range, therefore outside the target of public health policies.<sup>2,3,5,6</sup>

Another aspect to be considered is the impact of breast cancer on employment and income, increasing the percentage of the SUS-dependent population, which in March 2020 was already approximately 85% of the more than 9 million people from Ceará State. Health in Brazil has universal public funding with SUS, besides private funding/supplementary health. A third category that has recently emerged are popular clinics, which offer specialized consultations and complementary exams, targeted by patients who do not have the resources to access private/supplementary health and who do not perform procedures in SUS, highlighting herein the tracking mammography.

In the face of an erratic system and a population of knowledge and practices little used to early detect breast cancer, opportunistic screening is the moment with the possibility to identify suspicious lesions, in a system with little offer of services and saturated as to diagnostic complementation.<sup>16</sup>

The Oncology Education and Studies Group (*Grupo de Educação e Estudos Oncológicos* - GEEON) works as a differential in the state health network, exclusively serving SUS users, both local and reference. It accounts for 8% of the state's annual diagnoses, result of great efforts to ensure the expansion of the service offered. However, with the COVID-19 pandemic hitting the national territory in March, postponing consultations of patients in clinical conditions to wait, as well as mammographic screening was needed.<sup>8,9</sup>

Despite the reorganization of the services offered to adapt them to the sanitary conditions imposed at this time and the growing demand for new cases, the service showed a maximum reduction of 84% in the procedures offered.<sup>8,9,15</sup> The months of April and May suffered the greatest impact, considering that the capital was in a state of collapse in this period. In June, in view of the stabilization and flexibility of isolation rules, consultations gradually returned. Even though, there is still high absenteeism, which is possibly the result of population's fear of being exposed to the virus and urban violence, especially in public transport, which has not yet had 100% of its fleet restored.

The 60% drop in the identification of new cases reflects, among other characteristics, the erratic, routine diagnosis during opportunistic screening.<sup>17</sup> This achievement contributes to worsening the staging of new cases and, consequently, the survival of patients.<sup>16</sup> Consequently, there was also a 56% reduction in surgeries performed.

Both delayed diagnosis and treatment need to be reprogrammed, but always considering the screening and prioritization of suspicious lesions, especially palpable lesions, as well as the investigation of the findings of BI-RADS<sup>18</sup> categories 0, 4, and 5.

It is not yet possible to measure the full impact of the reduction in care in the diagnosis of the disease, being the responsibility of each service the monitoring of its indicators at the first moment, considering that public health management bodies are still concerned with the disease internalization.

Bringing patient navigation to this moment is a strategy that must be considered by managers, articulating the patient and the network with social distance, using telephone contact and text messages.<sup>5</sup>

The State Committee and the Municipal Breast Cancer Committee of Fortaleza City have the mission of articulating the health system, the civil society, and class entities to minimize the "distraction effect", especially on the eve of Pink October, date traditionally used in Brazil to disseminate content, raise awareness, and expand breast cancer screening.

## CONCLUSION

The findings represent a cause of great concern for the scenario after controlling the pandemic, given the increase in incidence, the low screening coverage, the high number of cases in advanced staging, the ascending mortality, the low supply of diagnostic services, aggravated by a reduction of up to 60% in diagnosis and up to 56% in surgical treatment in an SDM.

The assistance network is already saturated in most services, and the demand, which was repressed from March to June, will need to strengthen the offer to face the challenge of diagnosis and treatment in a timely manner, otherwise it will result in an even greater impact on mortality.

## AUTHORS' CONTRIBUTION

C.L.: Conceptualization, investigation, methodology, validation, data curation, formal analysis, investigation, writing – original draft, writing – review & editing.

L.P.: Conceptualization, methodology, project administration, supervision, validation, writing – review & editing.

P.V.: Conceptualization, investigation, validation, formal analysis, investigation, writing – original draft, writing – review & editing.

## REFERENCES

1. Ferlay J, Colombert M, Soerjomataram I, Mathers C, Parkin DM, Piñeros M, et al. Estimating the global cancer incidence and mortality in 2018: GLOBOCAN sources and methods. *Int J Cancer*. 2019;144(8):1941-53. <https://doi.org/10.1002/ijc.31937>
2. Instituto Nacional de Câncer José Alencar Gomes da Silva (INCA). Estimativa 2018: incidência de câncer no Brasil. Rio de Janeiro: INCA; 2018.
3. Instituto Nacional de Câncer José Alencar Gomes da Silva (INCA). Estimativa 2020: incidência de câncer no Brasil. Rio de Janeiro: INCA; 2019.
4. American Cancer Society (ACS). *Cancer Facts & Figures 2020*. Atlanta: American Cancer Society; 2020.
5. Gioia S, Brigagão L, Torres C, Lima A, Medeiros M. The implementation of patient navigation to improve mammography coverage and access to breast cancer in Rio de Janeiro. *Mastology*. 2019;29(4):186-92. <https://doi.org/10.29289/25945394201920190006>
6. Franzoi MA, Rosa DD, Zaffaroni F, Werutsky G, Simon S, Bines J, et al. Advanced State at Diagnosis and Worse Clinicopathologic Features in Young Women with Breast Cancer in Brazil: a Subanalysis of the AMAZONA III Study. *J Global Oncology*. 2019;(5):1-10. <http://doi.org/10.1200/JGO.19.00263>
7. World Health Organization. WHO Director-General's opening remarks at the media briefing on COVID-19 [Internet]. World Health Organization; 2020 [cited on Jun 25, 2020]. Available at: <https://www.who.int/dg/speeches/detail/who-director-general-s-opening-remarks-at-the-media-briefing-on-covid-19---11-march-2020>



8. Instituto Nacional de Câncer José Alencar Gomes da Silva (INCA). Nota Técnica – DIDEPRE/CONPREV/INCA – 30/3/2020. Detecção precoce de câncer durante a pandemia de Covid-19. Rio de Janeiro: INCA; 2020.
9. American College of Surgeons. COVID-19 Guidelines for Triage of Breast Cancer Patients [Internet]. American College of Surgeons; 2020 [cited on Jun 25, 2020]. Available at: <https://www.facs.org/covid-19/clinical-guidance/elective-case/breast-cancer>
10. Haar JV, Hoes LR, Coles CE, Seamon K, Fröhling S, Jäger D, et al. Caring for patients with cancer in the COVID-19 era. *Nat Med*. 2020;26:665-71. <https://doi.org/10.1038/s41591-020-0874-8>
11. Tang LV, Hu Y. Poor clinical outcomes for patients with cancer during the COVID-19 pandemic. *Lancet Oncol*. 2020;21(7):862-4. [https://doi.org/10.1016/S1470-2045\(20\)30311-9](https://doi.org/10.1016/S1470-2045(20)30311-9)
12. El-Shakankery KH, Kefas J, Crusz SM. Caring for our cancer patients in the wake of COVID-19. *Brit J Cancer*. 2020;123:3-4. <https://doi.org/10.1038/s41416-020-0843-5>
13. Cortiula F, Pettke A, Bartoletti M, Puglisi F, Helleday T. Managing COVID-19 in the oncology clinic and avoiding the distraction effect. *Editorial Annals of Oncology Eur Soc Med Oncol*. 2020;31(5):553-5. <https://doi.org/10.1016/j.annonc.2020.03.286>
14. Tan J, Yang C. Prevention and control strategies for the diagnosis and treatment of cancer patients during the COVID-19 pandemic. *Brit J Cancer*. 2020;123:5-6. <http://doi.org/10.1038/s41416-020-0854-2>
15. Facinal G, Oliveira VM. Breast cancer care during the coronavirus pandemic. *Mastology*. 2020;30:e20200014. <http://doi.org/10.29289/25945394202020200014>
16. World Health Organization. WHO list of priority medical devices for cancer management. Geneva: World Health Organization; 2017.
17. Instituto Nacional de Câncer José Alencar Gomes da Silva (INCA). Diretrizes para a detecção precoce do câncer de mama no Brasil. Rio de Janeiro: INCA; 2015.
18. Purcino FAC, Ruiz CA, Sorpreso ICE, Costa AMM, Soares-Junior JM, Baracat EC, et al. Management of benign and suspicious breast lesions during the coronavirus disease pandemic: recommendations for triage and treatment. *Clinics*. 2020;75:e2097. <https://doi.org/10.6061/clinics/2020/e2097>



# Prevalence and clinical implications of the TP53 p.R337H mutation in Brazilian breast cancer patients: a systematic literature review

Eduardo Silvestre Vaz Costa<sup>1</sup> , Isabelle Franco Melazzo<sup>1</sup> , Nathália Amaral Nogueira<sup>2</sup> ,  
Deidimar Cassia Abreu<sup>1</sup> , Flavio Monteiro Ayres<sup>3</sup> , Vera Aparecida Saddi<sup>1\*</sup> 

## ABSTRACT

This study assessed the prevalence and clinical implications of the TP53 p.R337H mutation in Brazilian breast cancer patients through a systematic literature review. The literature review was performed in the PubMed, Scientific Electronic Library Online (SciELO), and Medical Literature Analysis and Retrieval System Online (MEDLINE) databases from 1997 to 2018. We used the keyword “R337H” in the search since it resulted in the largest number of published articles on the subject. Initially, we found 75 articles, and, after reviewing the titles and abstracts, we selected 18 studies investigating the prevalence of the TP53 p.R337H mutation in breast cancer patients and its clinical implications. The reading of the full texts led to the inclusion of seven studies. The studies were carried out in the states of São Paulo, Rio Grande do Sul, Rio de Janeiro, and Bahia. The TP53 p.R337H mutation was detected in 87 (4.8%) of the 1.789 women with breast cancer investigated. The prevalence of the TP53 p.R337H mutation in the selected studies ranged from 0.5% to 8.6%. These findings highlight the recommendation for screening the R337H variant in breast cancer patients in Brazil and suggest the need for new research addressing the clinical and prognostic aspects of breast cancer patients with TP53 p.R337H mutation-positive.

**KEYWORDS:** genes, P53; cancer; mutation.

## INTRODUCTION

Breast cancer is an important public health problem, with high incidence in Brazil and worldwide. The study of breast carcinogenesis and risk factors for breast cancer is relevant to disease management, and numerous genes involved in the process of breast carcinogenesis have been identified.

Changes in the *TP53* pathway are significant in the pathogenesis of several human cancers<sup>1</sup>. In breast cancer, *TP53* mutations are found in 30%–35% of primary invasive tumors. However, the prevalence of mutations varies depending on the histological type of the disease, being found in up to 80% of triple-negative (TN) breast cancer, 10% of luminal A, 30% of luminal B, and in up to 70% of tumors rich in human epidermal growth factor

receptor 2 (HER2)<sup>2-4</sup>. In Brazil, a *TP53* mutation called p.R337H draws the attention of professionals who deal with breast cancer, as it has been identified in a significant portion of patients with this type of cancer<sup>5</sup>.

The tumor suppressor gene *TP53*, located on the short arm of chromosome 17 (17p13.1), encodes a nuclear phosphoprotein of 53 kilodaltons (kDa), which is responsible for regulating the expression of several genes that control the progression of the cell cycle, angiogenesis, and apoptosis, working as a transcription factor<sup>6</sup>. In normal cells, p53 is expressed at baseline levels. Nevertheless, when cells are exposed to agents that cause damage to the deoxyribonucleic acid (DNA), p53 expression increases and initiates transcriptional control of several target genes that prevent the cell cycle progression. Cell cycle

<sup>1</sup>Pontifícia Universidade Católica de Goiás – Goiânia (GO), Brazil.

<sup>2</sup>Universidade Federal de Goiás – Goiânia (GO), Brazil.

<sup>3</sup>Universidade Estadual de Goiás – Goiânia (GO), Brazil.

\*Corresponding author: verasaddi@gmail.com

Conflict of interests: nothing to declare.

Received on: 08/22/2019. Accepted on: 12/11/2019.

blockage allows repair of cell damage, preventing replication of DNA lesions potentially involved in tumor induction, as well as the division of abnormal cells. In the case of extensive genomic involvement, p53 induces cell death due to apoptosis, preventing the spread of genetic changes<sup>7</sup>.

Several functions are attributed to the p53 protein in the regulation of cellular response to genotoxic stress, such as that caused by ionizing radiation, free radicals, hypoxia, among others, as well as oncogene inactivation. The p53 protein also acts in the process of angiogenesis, cellular senescence, and inflammatory response<sup>8</sup>. The ability to recognize DNA damage and regulate the cell cycle closely connects the p53 protein to tumor suppression and cancer biology<sup>9</sup>. The p53 pathway can be influenced in several ways, either by the presence of somatic and germline mutations or by the presence of genetic polymorphisms. Several genes are involved in this cell regulation pathway, so a large spectrum of polymorphisms and mutations leads to individual variations in tumor phenotypes<sup>9</sup>.

Mutations that change the function of the protein encoded by the *TP53* gene, preventing its tumor suppressor activity, are widely described<sup>9</sup>. One of them, called p.R337H, was first identified in Brazil among children with adrenocortical tumors in families without a family history of cancer<sup>10</sup>. The mutation located in exon 10 of the *TP53* gene, codon 337, consists of exchanging guanine (CGC) for adenine (CAC), which results in the replacement of the amino acid arginine (R) for histidine (H) at position 337 of the protein<sup>11</sup>. The mutated allele encodes a protein with changes in the C-terminal domain, producing unstable p53 tetramers, which compromise its tumor suppressor function<sup>12</sup>. The biochemical repercussion of this mutation affects the ability of p53 to form oligomers. The formation of oligomers depends on an optimal pH, and acid-base changes in the amino acid sequence of p53 affect its biochemical properties<sup>12</sup>. At pH 7, the ability to form oligomers does not change, but in a slightly basic medium, oligomer formation is impaired<sup>13</sup>. Given this theory, several phenotypic variations present in families carrying the *TP53* p.R337H mutation are described<sup>14</sup>.

In Brazil, the *TP53* p.R337H mutation was initially detected in the Southern Region in individuals considered unrelated, but who later had their common ancestry elucidated<sup>15</sup>. The historical hypothesis explains the spread of the *TP53* p.R337H mutation by proposing that the opening of Estrada dos Tropeiros, a highway between São Paulo and the south of the country, led to the migration and distribution of *TP53* p.R337H carriers to the South and Southeast regions of Brazil, which characterized the so-called founder effect<sup>16</sup>.

Some studies<sup>17</sup> have investigated the prevalence of the *TP53* p.R337H mutation in Brazilian women with breast cancer. However, when comparing the different regions of the country, there are variations in prevalence and a higher concentration of studies in the South and Southeast regions. The penetrance of

the *TP53* p.R337H mutation is still poorly understood in Brazil, as well as its clinical implications in breast cancer. The *TP53* p.R337H mutation has proven to be relevant in the epidemiological context of cancer in Brazil, but few updated studies assess the prevalence and clinical implications of the mutation in the Brazilian population, especially for breast cancer<sup>17</sup>. Also, studies are concentrated in the South and Southeast of the country, while frequencies in other regions remain unknown.

This study comprises a systematic literature review that investigated the prevalence of the *TP53* p.R337H mutation in women with breast cancer in Brazil, as well as the association of the mutation with clinical implications of tumors. Given the relevance of the *TP53* p.R337H mutation in the current Brazilian scenario, this study can help oncology professionals in the clinical management of patients with the mutation and their families, as well as guide the development of new studies that address this issue.

## METHODS

### Search strategy

The bibliographic review was carried out in the PubMed, Scientific Electronic Library Online (SciELO), and Medical Literature Analysis and Retrieval System Online (MEDLINE) databases, from 1997 to 2018. We used the keyword “R337H” in the search, as it resulted in the largest number of published studies on the subject. The search was limited to articles published in Portuguese, English, and Spanish. Two researchers reviewed the titles and abstracts of the articles retrieved in the initial search to determine their relevance. Disagreements in the selection and inclusion of studies were solved by a meeting, re-reading, and discussion with a third researcher.

### Eligibility criteria

The articles chosen were considered eligible when they met the following inclusion criteria:

- articles investigating the prevalence of the *TP53* p.R337H mutation in Brazilian women with breast cancer;
- articles studying the influence of the *TP53* p.R337H mutation as a marker in the prognosis of breast cancer patients with this alteration;
- studies associating the *TP53* p.R337H mutation with the risk of developing breast cancer;
- primary and descriptive studies;
- articles presenting a clearly described methodology;
- studies with consistent objectives regarding the methodology;
- articles in Portuguese, English, and Spanish fully available online.

According to the exclusion criteria, the following studies were not eligible:

- publications in languages other than Portuguese, English, and Spanish;
- studies with repeated cases;
- articles investigating other *TP53* mutations in Brazilian breast cancer patients;
- case reports and systematic literature reviews.

### Data extraction and analysis

We extracted the following study data: title, first author, year of publication, study objective, population studied, number of participants, type of sample investigated, case origin, molecular methods of mutation assessment, and main results. The data obtained were reviewed and synthesized in tables.

## RESULTS

### Study selection

Initially, we found 75 studies by electronic data search. After reviewing the titles and abstracts of these articles, we selected 18 studies that investigated the prevalence of the *TP53* p.R337H mutation in breast cancer patients and its clinical implications. Reading the full texts of these articles resulted in the exclusion of 11 studies. In total, seven articles were eligible for the systematic review. Figure 1 shows the flowchart of the study selection process.

### Characteristics of included studies

The seven studies included in this systematic review evaluated a total of 2,456 patients with and without breast cancer, with and without the *TP53* p.R337H mutation. The number of patients analyzed in the different studies ranged from 28 to 874, and the included studies were carried out in the states of São Paulo, Rio de Janeiro, Rio Grande do Sul, and Bahia. São Paulo and Rio Grande do Sul were the states that most researched the subject. The oldest article was published in 2008, and the newest is from 2014. All seven studies were published in English. Table 1 presents the characteristics of the studies included in the systematic review.

The mutation assessment methods in the selected studies included: polymerase chain reaction (PCR) associated with the analysis of restriction fragment length polymorphism (RFLP), comparative genomic hybridization based on microarrays (CGH-array), gene sequencing, high-resolution melting (HRM), immunohistochemistry (IHC), and real-time PCR (qPCR), using TaqMan probes. The study that used immunohistochemistry assessed p53 protein expression for the presence of the R337H mutation in tumor specimens. In general, the most adopted mutation analysis method was PCR-RFLP, in three studies, while the qPCR method was used in two studies, and gene sequencing was used to confirm the detected mutations.

All studies included in the analysis investigated the *TP53* p.R337H mutation in blood samples (Table 1), except one<sup>18</sup>, which investigated the mutation only in specimens of phyllodes tumors. Two studies<sup>19,20</sup> that examined *TP53* p.R337H in blood samples also investigated the mutation in tumor samples.

### Prevalence of *TP53* p.R337H mutation in Brazilian women with breast cancer

Seven studies investigated the prevalence of the *TP53* p.R337H mutation in a total of 1,789 women with breast cancer, of whom 87 (4.8%) had the *TP53* p.R337H mutation (Table 2). The frequencies of the *TP53* p.R337H mutation in the selected studies ranged from 0.5%<sup>21</sup> to 8.6%<sup>20</sup>.

Among the selected studies, three were control cases<sup>19,21,22</sup>, and they assessed the prevalence of the *TP53* p.R337H mutation in 1,208 women — 541 with breast cancer and 667 without breast cancer. The *TP53* p.R337H mutation was detected in seven of 541 patients in the case group (1.3%) and no woman in the control

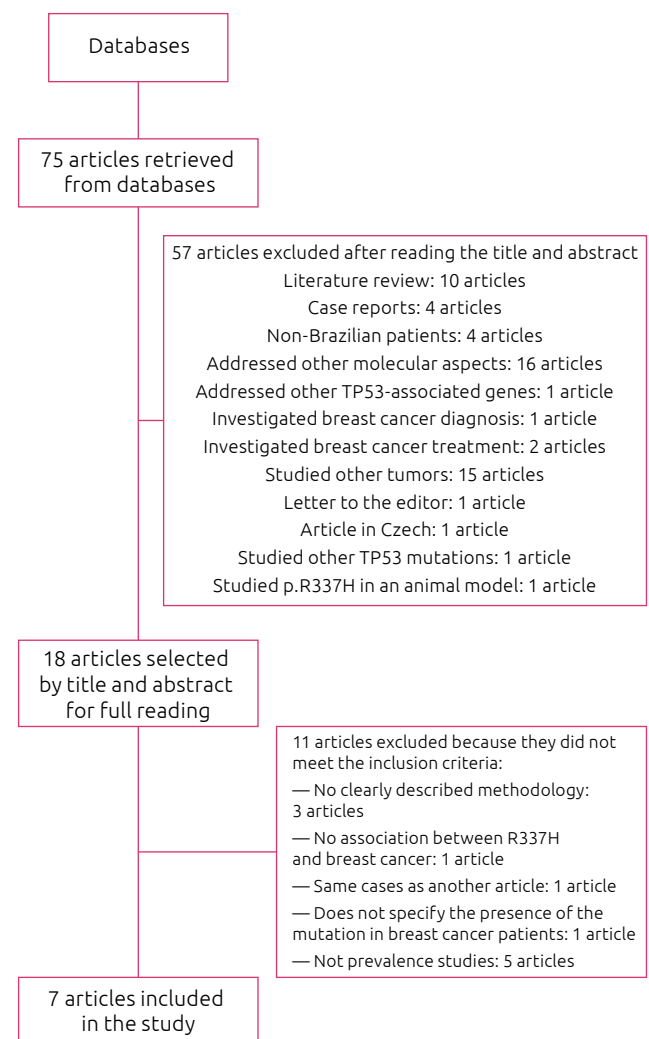

Figure 1. Flowchart of the study selection process.

**Table 1.** Characteristics of the studies included in the systematic review.

Reference	Case Origin	Objective/Sampling	Analyzed Biological Material/ Method	Results
Silva et al., 2014 <sup>14</sup>	São Paulo, SP, Brazil	To investigate genetic changes in a group of 120 women with hereditary breast and ovarian cancer (HBOC) syndrome.	Blood. CGH-array and real-time PCR for mutation detection.	Three out of 120 women with breast cancer had the <i>TP53</i> p.R337H mutation.
Giacomazzi et al., 2013 <sup>18</sup>	Porto Alegre, RS, Brazil; Barretos, SP, Brazil	To assess the presence of the <i>TP53</i> p.R337H mutation in 148 women with phyllodes tumor.	Tumor sample. Real-time PCR/TaqMan and DNA sequencing.	Eight out of 148 women had the <i>TP53</i> p.R337H mutation, three with a malignant tumor and five with a benign tumor.
Assumpção et al., 2008 <sup>19</sup>	Campinas, SP, Brazil	To determine the prevalence of the <i>TP53</i> p.R337H mutation in 123 women with breast cancer and 223 control women without breast cancer.	Blood and tumor sample. PCR-RFLP and IHC to detect the mutated protein.	Three out of 123 women with breast cancer had the <i>TP53</i> p.R337H mutation, and no women in the control group had the mutation.
Giacomazzi et al., 2014 <sup>20</sup>	Porto Alegre, RS, Brazil	To assess the prevalence of the <i>TP53</i> p.R337H mutation in a group of 874 women with breast cancer.	Blood and tumor sample. Real-time PCR/TaqMan for mutation detection, DNA sequencing, and PCR-RFLP for tumor tissue analysis.	Out of the 874 breast cancer patients, 72 had the <i>TP53</i> p.R337H mutation.
Gomes et al., 2012 <sup>21</sup>	Rio de Janeiro, RJ, Brazil	To assess the prevalence of the <i>TP53</i> p.R337H mutation in 390 women with breast cancer and 324 controls without breast cancer.	Blood. Allele-specific PCR (amplification refractory mutation system — ARMS) and DNA sequencing.	Two out of the 390 women in the case group had the <i>TP53</i> p.R337H mutation. No woman in the control group had the mutation.
Cury et al., 2014 <sup>22</sup>	Ribeirão Preto, SP, Brazil	To investigate the prevalence of the <i>TP53</i> p.R337H mutation in 28 women with HBOC and 120 controls without cancer.	Blood. High resolution melting (HRM) for mutation detection.	Two out of 28 women with breast cancer had the <i>TP53</i> p.R337H mutation. No woman in the control group had the mutation.
Felix et al., 2014 <sup>24</sup>	Salvador, BA, Brazil	To investigate mutations in 106 women with HBOC.	Blood. Allele-specific PCR, PCR-RFLP, and DNA sequencing.	One out of 106 women with HBOC had the <i>TP53</i> p.R337H mutation.

PCR: polymerase chain reaction; DNA: deoxyribonucleic acid; RFLP: restriction fragment length polymorphism; CGH-array: comparative genomic hybridization based on microarrays; IHC: immunohistochemistry.

**Table 2.** Studies that investigated the prevalence of the *TP53* p.R337H mutation in Brazilian patients with breast cancer (BC).

Reference	N	Inclusion criteria	Investigated gene region	Mutation screening method	N (%) p.R337H
Giacomazzi et al., 2014 <sup>20</sup>	59	High-risk BC	<i>TP53</i> p.R337H	qPCR TaqMan, sequencing, and PCR-RFLP	2 (3.4)
Giacomazzi et al., 2014 <sup>20</sup>	815	Unselected BC	<i>TP53</i> p.R337H	qPCR TaqMan, sequencing, and PCR-RFLP	70 (8.6)
Silva et al., 2014 <sup>14</sup>	120	High risk BC	<i>TP53</i> p.R337H	CGH-array and qPCR	3 (2.5)
Giacomazzi et al., 2013 <sup>18</sup>	148	Phyllodes tumor	<i>TP53</i> p.R337H	qPCR TaqMan, sequencing	3 (2.0)
Assumpção et al., 2008 <sup>19</sup>	123	Unselected BC	<i>TP53</i> p.R337H, <i>TP53</i> gene exon 10	PCR-RFLP and IHC	3 (2.4)
Gomes et al., 2012 <sup>21</sup>	390	Unselected BC	<i>TP53</i> p.R337H	ARMS-PCR, sequencing	2 (0.5)
Cury et al., 2014 <sup>22</sup>	28	High risk BC	Full gene by HRM	HRM	2 (7.1)
Felix et al., 2014 <sup>24</sup>	106	High risk BC	<i>TP53</i> p.R337H	AS-PCR, PCR-RFLP, sequencing	1 (0.9)

HRM: high-resolution melting; qPCR: real-time polymerase chain reaction; PCR: polymerase chain reaction; RFLP: restriction fragment length polymorphism; CGH-array: comparative genomic hybridization based on microarrays; AS-PCR: allele-specific PCR; ARMS: amplification refractory mutation system; IHC: immunohistochemistry.

group (Table 3). Two of these studies<sup>19,21</sup> reported that the women with breast cancer who had the *TP53* p.R337H mutation were under 45 years old. The third study<sup>22</sup> described two patients with *TP53* p.R337H, one diagnosed at the age of 30 and another with bilateral breast cancer, whose first cancer was detected at the age of 61, in the right breast, and the second at the age of 62, in the left breast. The data available in the selected studies did not allow a more detailed analysis of the age or clinical characteristics of patients with breast cancer and *TP53* p.R337H mutation.

### Clinical implications in patients with the *TP53* p.R337H mutation and breast cancer

Information regarding clinical tumor characteristics, such as age at diagnosis, histological type, clinical staging, and status of immunohistochemical markers, is scarce in studies assessing the *TP53* p.R337H mutation in breast cancer patients. None of them followed the patients' response after the cancer diagnosis, nor did they assess the recurrence and/or survival of those carrying the *TP53* p.R337H mutation.

Regarding the age of the patients, a study carried out in Rio de Janeiro<sup>21</sup> evaluated a series of 390 breast cancer patients, with ages ranging from 25–60 years and a mean age of 46 years at diagnosis. Two patients (0.5%) under the age of 40 presented the *TP53* p.R337H mutation, one aged 35 years and the other aged 39 years. The two patients with the *TP53* p.R337H mutation reported a family history of other cancers.

The largest series of breast cancer cases selected in this review<sup>20</sup> investigated the prevalence of the mutation in women with breast cancer in different age groups. The study included 403 patients diagnosed with breast cancer before the age of 42 and 412 aged 55 years or older. The mean age of the patients at diagnosis was 38 (standard deviation — SD=5) and 66 (SD=9) years, respectively, in both groups. Invasive carcinomas were the most prevalent (90.5%), and the genotyping performed on tumor specimens showed a prevalence of the *TP53* p.R337H mutation of 8.6% in genotyped samples. The study also revealed an inverse relationship between age and mutation prevalence: in the group of women diagnosed at the age of 45 or younger, the prevalence was 12.1%, while in women diagnosed at the age

of 55 or older, the prevalence was 5.1% ( $p < 0.001$ ). When women with breast cancer diagnosed at the age of 30 or younger were assessed, the prevalence of the mutation was 20% (8/40, 95% confidence interval — 95%CI 9.0–35.6%). The analysis of *TP53* p.R337H in the tumors indicated that, out of the 70 mutation-positive cases, 68 (97.1%) were heterozygous (c.1010 AG). Only two cases had mutant alleles detected in the tumors, suggesting that the patients were constitutive mutant homozygotes or hemizygotes.

Regarding the histological type of the tumors, most studies mentioned that the *TP53* p.R337H mutation-positive tumors were invasive carcinomas, without other specifications. One study<sup>18</sup> assessed the prevalence of the *TP53* p.R337H mutation in 148 women with phyllodes tumors, reporting the presence of the mutation in eight women and classifying the mutant cases as malignant (n=3), benign (n=5), and borderline (n=0). A malignant phyllodes tumor with the *TP53* p.R337H mutation has also been described in a study developed in the Southern region of the country<sup>19</sup>.

## DISCUSSION

In Southern Brazil, the germline *TP53* p.R337H mutation is highly associated with pediatric adrenocortical tumors and has low penetrance and limited tumor specificity in most families presenting this mutation. Among mutation-associated tumors, breast cancer is the most frequently found in *TP53* p.R337H-positive women, suggesting that this variant is relevant for breast carcinogenesis. Based on the studies included in this systematic review, the prevalence of the *TP53* p.R337H mutation in Brazilian breast cancer patients is high, ranging from 0.5% to 8.6%. These findings reinforce the recommendation for screening the R337H variant in breast cancer patients in Brazil.

The role of the R337H mutation in breast cancer is not yet clear. Most (90%) of the germline mutations in the *TP53* gene are in its DNA-binding domain. These mutations interrupt the protein structure and impair the function of the encoded protein. In contrast, the germline *TP53* p.R337H mutation occurs in the p53 tetramerization domain and seems to cause a more subtle

**Table 3.** Case-control studies that investigated the prevalence of the TP53 p.R337H mutation in breast cancer patients.

Reference	Type of study	Number of cases/ controls	TP53 p.R337H	Age of patients at diagnosis
Assumpção et al., 2008 <sup>19</sup>	Control case	123 cases 223 controls	3/123 0/223	19 years, 29 years, and 44 years Mean age: 30.6 years
Gomes et al., 2012 <sup>21</sup>	Control case	390 cases 324 controls	2/390 0/324	35 years and 39 years Mean age: 37 years
Cury et al., 2014 <sup>22</sup>	Control case	28 cases 120 controls	2/28 0/120	30 years, 61 years (left breast), and 62 years (right breast) Mean age: 45.5 years

defect in the protein, which becomes functionally deficient only under certain conditions.

Germline *TP53* mutations are related to the Li-Fraumeni syndrome (LFS) with cancer predisposition. Individuals with germline *TP53* mutations have two characteristic disease phases, one in childhood with a tendency to develop rare cancers and one in adulthood with a tendency to develop more common cancers, but with early onset. The risk of childhood cancer versus adult cancer depends on the type of *TP53* mutation, as well as on genetic modifiers, including polymorphisms in *TP53* and genes encoding p53 regulators, such as murine double minute 2 (*Mdm2*), among others<sup>9</sup>.

A recent study used a full genome sequencing to analyze a 2 Mb region at the *TP53* locus in samples of adrenocortical carcinomas. Selected common and rare variants were genotyped in 204 *TP53* p.R337H-positive cancer patients and a control group of 67,359 newborns. A commonly shared haplotype containing the E134\* variant of the *XAF1* gene was detected in a subgroup (42%) of patients with adrenocortical carcinomas. This rare variant was identified in 70% of patients with *TP53* p.R337H. The cosegregation of both variants was found in 79% of cancer patients and was significantly higher in individuals with sarcoma and multiple malignancies, including breast cancer<sup>23</sup>. The results of this study should be expanded and may contribute to elucidate the role of the *TP53* R337H mutation and its modifiers.

The studies included in this review were conducted in the states of São Paulo, Rio de Janeiro, Rio Grande do Sul, and Bahia. São Paulo and Rio Grande do Sul had the largest number of publications on the subject, and the highest prevalence of *TP53* p.R337H mutation in women with breast cancer was found in Porto Alegre (8.6%) and Ribeirão Preto (7.1 %). A study carried out in Bahia showed that one out of 106 women with breast cancer assessed had the *TP53* p.R337H mutation, indicating that the mutation is not restricted to the South and Southeast regions<sup>24</sup>.

One of the studies included in the systematic review<sup>20</sup> investigated the prevalence of the *TP53* p.R337H mutation in a large group of breast cancer patients from three important reference centers for cancer treatment in Brazil and performed the geographical distribution of the cases assessed. The study revealed a significant variation in the disposition of breast cancer cases with the *TP53* p.R337H mutation. This variation can be explained by the differential dissemination of the founder haplotype in some regions of the country due to the migratory effect and sociodemographic differences that intrinsically affect the risk of developing breast cancer in the Brazilian population. The lack of studies in different geographic regions of Brazil demands the development of new research on this subject.

The studies included in this article used several methods to detect the *TP53* p.R337H mutation, especially PCR-RFLP and qPCR with TaqMan probes. An investigation that assessed 95 genomic DNA samples compared the performance, cost, and response time of the Sanger, PCR-RFLP, TaqMan-PCR, and HRM

sequencing methods employed in the *TP53* p.R337H genotyping, and the results were 100% concordant for all methods<sup>25</sup>. Nonetheless, DNA sequencing is considered the gold standard among the methods and recommended to confirm the mutation.

This systematic review included three case-control studies<sup>19,21,22</sup>. The *TP53* p.R337H mutation was detected in seven of the 541 patients in the case group (1.3%), and none of the 667 women in the control group. Despite the considerable number of cases evaluated, the heterogeneity of the studies did not allow a combined analysis of the data in the form of meta-analysis, which prevented the assessment of the risk of *TP53* p.R337H-positive patients developing breast cancer.

An important limitation of this study is the fact that prognostic aspects of *TP53* p.R337H-positive breast cancer could not be assessed since none of the included articles addressed these variables. Retrospective studies that include large series and the possibility of patient follow-up are necessary to elucidate the prognostic role of the *TP53* p.R337H mutation in breast cancer.

As described in the "Results" section, information regarding clinical tumor characteristics, such as their histological type, clinical staging, and status of immunohistochemical markers, was extremely scarce in the studies included in this work. Immunohistochemical data from 66 breast cancer patients positive for *TP53* p.R337H were reviewed and compared to data from 12 patients with other functional *TP53* mutations<sup>26</sup>. In the group of patients with other functional *TP53* mutations, 75% of the tumors showed overexpression of HER2 (3+), corroborating previous studies, while 22.7% of the patients with *TP53* p.R337H presented HER2 overexpression. These results reinforce the hypothesis that different germline *TP53* mutations act through different pathways of carcinogenesis, suggesting that the histopathological and immunohistochemical aspects of *TP53* p.R337H-positive breast cancer should be further investigated in future studies.

The seven studies included in this review showed that 87 (4.8%) of the 1,789 women with breast cancer investigated in Brazil had the *TP53* p.R337H mutation. These results indicate that the *TP53* p.R337H variant contributes to an important portion of breast cancers diagnosed in our population and that screening for this variant needs to be considered in the diagnosis and prevention of these tumors. The prevalence of the *TP53* p.R337H variant is high when compared to other particular mutations detected in *TP53* and should be taken into account in the genetic counseling of Brazilian breast cancer patients.

## AUTHORS' CONTRIBUTIONS

V.A.S.: Conceptualization, funding acquisition, investigation, methodology, investigation, project administration, supervision, validation, visualization, writing – review & editing.

D.C.A.: investigation, validation, visualization, writing – review & editing.

E.S.V.C.: Data curation, formal analysis, Investigation, writing – original draft.

I.F.M.: Data curation, formal analysis, investigation, writing – original draft.

N.A.N.: Conceptualization, data curation, formal analysis, investigation, visualization, writing – original draft, writing – review & editing.

F.M.A.: Methodology, validation, writing – review & editing.

## REFERENCES

- Hoadley KA, Yau C, Wolf DM, Cherniack AD, Tamborero D, Ng S, et al. Multiplatform analysis of 12 cancer types reveals molecular classification within and across tissues of origin. *Cell*. 2014;158(4):929-44. <https://doi.org/10.1016/j.cell.2014.06.049>
- Shah SP, Roth A, Goya R, Oloumi A, Ha G, Zhao Y, et al. The clonal and mutational evolution spectrum of primary triple-negative breast cancers. *Nature*. 2012;486(7403):395-9. <https://doi.org/10.1038/nature10933>
- Silwal-Pandit L, Vollan HK, Chin SF, Rueda OM, McKinney S, Osako T, et al. TP53 mutation spectrum in breast cancer is subtype specific and has distinct prognostic relevance. *Clin Cancer Res*. 2014;20(13):3569-80. <https://doi.org/10.1158/1078-0432.CCR-13-2943>
- Nik-Zainal S, Davies H, Staaf J, Ramakrishna M, Glodzik D, Zou X, et al. Landscape of somatic mutations in 560 breast cancer whole-genome sequences. *Nature*. 2016;534(7605):47-54. <https://doi.org/10.1038/nature17676>
- Hahn EC, Bittar CM, Vianna FSL, Netto CBO, Biazús JV, Cericatto R, et al. TP53 p. Arg337His germline mutation prevalence in Southern Brazil: Further evidence for mutation testing in young breast cancer patients. *PLoS One*. 2018;13(12):e0209934. <https://doi.org/10.1371/journal.pone.0209934>
- Levine AJ, Oren M. The first 30 years of p53: growing ever more complex. *Nat Rev Cancer*. 2009;9(10):749-58. <https://doi.org/10.1038/nrc2723>
- Levine AJ. The many faces of p53: something for everyone. *J Mol Cell Biol*. 2019;11(7):524-30. <https://doi.org/10.1093/jmcb/mjz026>
- Wasserman JD, Zambetti GP, Malkin D. Towards an understanding of the role of p53 in adrenocortical carcinogenesis. *Mol Cell Endocrinol*. 2012;351(1):101-10. <https://dx.doi.org/10.1016%2Fj.mce.2011.09.010>
- Blandino G, Deppert W, Hainaut P, Levine A, Lozano G, Olivier M, et al. Mutant p53 protein, master regulator of human malignancies: a report on the Fifth Mutant p53 Workshop. *Cell Death Differ*. 2012;19(1):180-3. <https://dx.doi.org/10.1038%2Fcd.2011.148>
- Latronico AC, Pinto EM, Domenice S, Fragoso MC, Martin RM, Zerbini MC, et al. An inherited mutation outside the highly conserved DNA-binding domain of the p53 tumor suppressor protein in children and adults with sporadic adrenocortical tumors. *J Clin Endocrinol Metab*. 2001;86(10):4970-3. <https://doi.org/10.1210/jcem.86.10.7957>
- Ribeiro RC, Sandrini F, Figueiredo B, Zambetti GP, Michalkiewicz E, Lafferty AR, et al. An inherited p53 mutation that contributes in a tissue-specific manner to pediatric adrenal cortical carcinoma. *Proc Natl Acad Sci*. 2001;98(16):9330-5. <https://doi.org/10.1073/pnas.161479898>
- Digiammarino EL, Lee AS, Cadwell C, Zhang W, Bothner B, Ribeiro RC, et al. A novel mechanism of tumorigenesis involving pH-dependent destabilization of a mutant p53 tetramer. *Nat Struct Biol*. 2002;9(1):12-6. <https://doi.org/10.1038/nsb730>
- Macedo GS, da Motta LL, Giacomazzi J, Netto CBO, Manfredini V, Vanzin CS, et al. Increased Oxidative Damage in Carriers of the Germline TP53p.R337H Mutation. *PLoS One*. 2012;7(10):e47010. <https://doi.org/10.1371/journal.pone.0047010>
- Silva FC, Lisboa BCG, Figueiredo MCP, Torrezan GT, Santos EMM, Krepschi AC, et al. Hereditary breast and ovarian cancer: assessment of point mutations and copy number variations in Brazilian patients. *BMC Med Genet*. 2014;15:55. <https://doi.org/10.1186/1471-2350-15-55>
- Garritano S, Gemignani F, Palmero EI, Olivier M, Martel-Planche G, Le Calvez-Kelm F, et al. Detailed Haplotype Analysis at the TP53 Locus in p.R337H Mutation Carriers in the Population of Southern Brazil: Evidence for a Founder Effect. *Hum Mutat*. 2010;31(2):143-50. <https://doi.org/10.1002/humu.21151>
- Achatz MI, Olivier M, Le Calvez F, Martel-Planche G, Lopes A, Rossi B, et al. The TP53 mutation, R337H, is associated with Li-Fraumeni and Li-Fraumeni-like syndromes in Brazilian families. *Cancer Lett*. 2007;245(1-2):96-102. <https://doi.org/10.1016/j.canlet.2005.12.039>
- Borges LM, Ayres FM. R337H mutation of the TP53 gene as a clinical marker in cancer patients: a systematic review of literature. *Genet Mol Res*. 2015;14(4):17034-43. <https://doi.org/10.4238/2015.December.16.4>
- Giacomazzi J, Koehler-Santos P, Palmero EI, Graudenz MS, Rivero LF, Lima E, et al. A TP53 founder mutation, p.R337H, is associated with phyllodes breast tumors in Brazil. *Virchows Arch*. 2013;463(1):17-22. <https://doi.org/10.1007/s00428-013-1439-8>
- Assumpção JG, Seidinger AL, Mastellaro MJ, Ribeiro RC, Zambetti GP, Ganti R, et al. Association of the germline TP53 R337H mutation with breast cancer in southern Brazil. *BMC Cancer*. 2008;8:357. <https://doi.org/10.1186/1471-2407-8-357>
- Giacomazzi J, Graudenz MS, Osorio CA, Koehler-Santos P, Palmero EI, Zagonel-Oliveira M, et al. Prevalence of the TP53 p.R337H mutation in breast cancer patients in Brazil. *PLoS One*. 2014;9(6):e99893. <https://doi.org/10.1371/journal.pone.0099893>
- Gomes MC, Kotsopoulos J, de Almeida GL, Costa MM, Vieira R, Filho AGF, et al. The R337H mutation in TP53 and breast cancer in Brazil. *Hered Cancer Clin Pract*. 2012;10(1):3. <https://dx.doi.org/10.1186%2F1897-4287-10-3>
- Cury NM, Ferraz VEF, Silva WA Jr. TP53 p.R337H prevalence in a series of Brazilian hereditary breast cancer families. *Hered Cancer Clin Pract*. 2014;12(1):8. <https://doi.org/10.1186/1897-4287-12-8>



23. Pinto E, Figueiredo B, Galvão H, Fragoso M, Ribeiro E, Diekmann Y, et al. SAT-LB058 Effect of a Genetic Modifier of Cancer Risk in TP53 Mutation Carriers. *J Endocr Soc.* 2019;3(Supl. 1):SAT-LB058. <https://dx.doi.org/10.1210%2Fjs.2019-SAT-LB058>
24. Felix GE, Abe-Sandes C, Machado-Lopes TMB, Bomfim TF, Guindalini RSC, Santos VCS, et al. Germline mutations in BRCA1, BRCA2, CHEK2 and TP53 in patients at high-risk for HBOC: characterizing a Northeast Brazilian Population. *Hum Genome Var.* 2014;1:14012. <https://dx.doi.org/10.1038%2Fhgv.2014.12>
25. Fitarelli-Kiehl M, Macedo GS, Schlatter RP, Koehler-Santos P, Matte Uda S, Ashton-Prolla P, et al. Comparison of multiple genotyping methods for the identification of the cancer predisposing founder mutation p.R337H in TP53. *Genet Mol Biol.* 2016;39(2):203-9. <https://doi.org/10.1590/1678-4685-GMB-2014-0351>
26. Fitarelli-Kiehl M, Giacomazzi J, Santos-Silva P, Graudenz MS, Palmero EI, Michelli RAD, et al. The breast cancer immunophenotype of TP53-p.R337H carriers is different from that observed among other pathogenic TP53 mutation carriers. *Fam Cancer.* 2015;14(2):333-6. <https://doi.org/10.1007/s10689-015-9779-y>



# Robotic breast surgery: the pursue for excellence in treatment and satisfaction – a review

Paula Clarke<sup>1\*</sup> , Douglas de Miranda Pires<sup>1</sup> , Nayara Carvalho de Sá<sup>1</sup> ,  
Jessica Moreira Cavalcante<sup>1</sup> , Fernanda Silveira de Oliveira<sup>1</sup> 

## ABSTRACT

**Introduction:** Nipple sparing mastectomy (NSM) with immediate reconstruction is an option for the treatment of breast cancer or for risk-reducing surgery. This technique offers good aesthetic results without compromising oncological safety. Robotic nipple sparing mastectomy (RNSM) was first described in 2015 and has been executed in various centers ever since, but the cost-effectiveness and oncological safety of this technique are still questioned. **Objectives:** The primary aim of this study was to critically review the literature and discuss the feasibility, advantages and limitations of robotic breast surgery. **Methods:** Search in PubMed database for publications related to “robotic breast surgery”. Selection and review of relevant articles, and analysis of results from these studies. **Results:** Our search comprised the period between 2015 and 2019. The rates of complications were low and the learning curve is apparently rapid, though there is still a lack of data involving cost-effectiveness. **Conclusions:** RNSM with immediate reconstruction is a great advance in the surgical treatment for breast cancer. Cost-effectiveness and oncological safety must still be accessed through randomized clinical trials.

**KEYWORDS:** breast neoplasms; robotic surgical procedures; mastectomy, subcutaneous; breast implants.

## INTRODUCTION

Breast cancer diagnosis and surgery have evolved toward less invasive procedures throughout the years. Breast conserving surgeries are largely carried out and mastectomies no longer have to be disfiguring. More than ever, breast surgeons are committed to improve their techniques in order to offer better aesthetic outcomes, which relate to better quality of life and self-image appreciation<sup>1</sup>.

Nipple sparing mastectomy (NSM) was described in 1984 by Hinton et al. as a safe alternative to simple mastectomy. In a series of 98 patients submitted to subcutaneous mastectomy, the skin envelope was preserved and reconstruction was performed about 6 months later; there was no increase in local recurrence of the skin flaps in a follow-up of 30 months<sup>2</sup>. The term NSM with immediate reconstruction was first used by Toth and Lappert in 1991, and in the same year by Kroll et al., who published a series of 104 cases, with similar local recurrences, after a mean follow-up of 5.6 years<sup>3,4</sup>. NSM is nowadays an option for the treatment of breast cancer, when following appropriate indications, and also

for risk-reducing surgery, offering good aesthetic results without compromising oncological safety<sup>5</sup>.

More recently, endoscopic breast surgery was attempted, but due to technical difficulties, it was not adopted in clinical practice<sup>6,7</sup>. In the context of minimally invasive approaches, the use of robotic surgery has become popular in urologic, gynecological, and colorectal procedures, and more recently, in the fields of thyroidectomy, oropharyngeal, and plastic surgery<sup>7</sup>. The first report of breast robotic surgery happened in 2015 by Toesca et al., who performed robotic nipple sparing mastectomy (RNSM)<sup>8</sup> with a DaVinci S robotic platform and since then a similar procedure has been executed in other centers. Surgeons claim that the advantages of RNSM are better aesthetic outcomes, with minimal scars hidden under the arm, enhanced precision with three-dimensional optics, reduced tremor and less bleeding<sup>7-10</sup>. The objective of this review was to discuss the feasibility, advantages, and limitations of robotic breast surgery, especially RNSM.

<sup>1</sup>Clínica de Mastologia, Santa Casa de Belo Horizonte – Belo Horizonte (MG), Brazil.

\*Corresponding author: drapaulaclarke@gmail.com

Conflict of interests: nothing to declare.

Received on: 08/24/2019. Accepted on: 11/12/2019

## METHODS

A search was performed in PubMed database for articles related to robotic breast surgery, published from 2015, year known to be the first report, until June 2019. The search identified 163 related articles. Titles that did not relate to breast surgery or breast cancer were excluded. This resulted in 27 abstracts to be read, which mentioned internal mammary robotic surgery, robotic harvesting of flaps, or RNSM with or without robotic reconstruction. Only the 19 abstracts mentioning RNSM were considered and read in their entirety. Of these, six were selected to analyze the data, excluding duplicates, editorials, letters to the editor, or response to letters to the editor. Surgeries performed in cadavers were not included in the data analysis, but considered for technical detail information.

## RESULTS

The first report of RNSM was carried out in 2015 by Toesca in the Istituto Europeo di Oncologia (IEO), with the objective to study an innovative technique and overcome the limitations of the endoscopic approach. Three patients with BRCA mutations, previously treated for unilateral breast cancer, who wanted to undergo a contralateral risk-reducing surgery were submitted to the procedure<sup>8</sup>. Following this, Sarfati et al. conducted a similar procedure on breasts of two fresh female cadavers<sup>9</sup>.

Since then, other centers have published their cases, describing different aspects in positioning, incision, complications, and follow-up results. Studies data are summarized in Table 1.

## Patients

The studies involve a total of 160 patients. Toesca et al.<sup>7</sup> reported that their first three cases were prophylactic contralateral RNSM in patients previously treated for breast cancer, but after they gained knowledge of how to remove the gland, they extended the indication for patients with breast cancer, reporting a total of 29 RNSM in 24 women. The tumor had to be situated at least 1cm from the nipple areola complex (NAC), in patients with no associated comorbidities, body mass index (BMI) < 25, and who were at low risk for anesthesia. Exclusion criteria were: grade 2 ptosis or higher, diabetes, heavy smoking, obesity or previous radiation therapy. In 2016, Sarfati et al. reported their first experience with RNSM in two fresh female cadavers<sup>11</sup>, and later in June 2018, published their study involving 62 prophylactic, and only 1 therapeutic RNSM<sup>9</sup>. The breasts had ptosis grade 1 or 2, they were of small breast cup size, the tumor had to be at least 2 cm away from the NAC, and a high-risk genetic mutation had been identified in the prophylactic group. Patients were excluded if they had a history of breast surgery or radiation, if post-operative radiation was required, and also heavy smokers or patients with uncontrolled diabetes mellitus. Lai et al.<sup>10</sup> performed 39 RNSM in 33 women, most of which (35 breasts) were therapeutic. Patients were

diagnosed with ductal carcinoma *in situ* (DCIS) or invasive breast cancer stages I, II, or IIIA, with a tumor size < 5cm and no evidence of multiple lymph node metastasis. Patients with severe comorbidities, skin, chest or nipple invasion, locally advanced or inflammatory disease were excluded. Houvenaeghel et al.<sup>12</sup> performed 27 RNSM in 17 patients with primary breast cancer and 10 with local recurrences. Characteristics of patients were determined and they were divided into three groups, each with different approaches for breast dissection. Park et al.<sup>13</sup> and Rajappa et al.<sup>14</sup> describe each, their experience with 1 case only.

## Positioning

Toesca et al. first described a flat supine position, with the arm above the head, internal rotation, and 90° abduction, lying on a chopping block placed under the back<sup>8</sup>, but this patient developed a temporary biceps brachii strength reduction. Because of that, in the following cases, the upper arm hung normally alongside the body, and the elbow was bent at about 30° so that the hand, wrist, and forearm were straight and roughly parallel to the floor at the side of the bed<sup>7</sup>. Sarfati and Lai describe a supine position with abduction at 90° of the arm<sup>9,10</sup>. Houvenaeghel et al. and Park et al. describe a supine, dorsal decubitus, with ante-flexion of the arm<sup>12,13</sup>. Rajappa et al. reported positioning as Toesca's et al.<sup>14</sup>.

## Incision and technique

Different techniques were described, though having one thing in common: an incision under the axilla, hidden by the arm. Incision size varied from as small as 2.5 to 6cm, in the mid-axillary or anterior axillary line. This size is mainly determined by the size of the breast to be removed through the same incision. In some series, a second small incision was made inferior to the first, in order to insert another trocar and the drain at the end of the procedure<sup>9,12</sup>. Most studies describe subcutaneous flap dissection with non-robotic scissors or electrocautery<sup>7,9,13,14</sup> to gain space for placing the port and docking. Houvenaeghel et al.<sup>12</sup> divided their patients into three groups in order to compare time of procedures:

- group 1: dissection with robotic scissors using coagulation;
- group 2: dissection with robotic scissors without coagulation;
- group 3: dissection with non-robotic scissors after subcutaneous infiltration with adrenaline serum and then robotic dissection.

Except for Park et al.<sup>13</sup>, who used no gas but retractors to maintain the working space, all other surgeries were performed under low pressure of 7-8 mmHg of carbon dioxide<sup>7,9,10,12,14</sup>. Dissection of the gland was performed with monopolar curved-scissors or cautery, moving from the axilla toward the nipple areola complex, medially, superiorly and inferiorly around the breast. An intraoperative biopsy of the retroareolar region in therapeutic surgeries was usually done with intraoperative frozen sections in series by Toesca et al. and Park et al. Lymph node dissection was performed through axillary incision, so as the removal of breast

gland, placement of prosthesis and, in cases of reconstruction with the latissimus dorsi, dissection of the flap were also done through the same incision.

### Surgery time

It is understandable that with a new technique, surgical time will be long. The first operation by Toesca et al. took 7 hours, needing conversion to open surgery, due to prolonged surgery time<sup>8</sup>. The last cases were completed in about 3 hours, including docking, dissection and reconstruction. All studies report the same outline, with a fast learning curve. In Houvenaeghel et al.'s study, the different groups had very different surgery times, and the longest procedures were those with robotic dissection<sup>12</sup>. According to Lai et al., the larger the breast, the longer time was needed in the initial cases, but operation time decreased significantly in the mature phase and did not fluctuate with specimen weight<sup>10</sup>. Another factor that

has influence over surgical time is the prophylactic or therapeutic indication of procedure, because of the need to do a biopsy of retroareolar region, with intraoperative frozen section. Surgical time data can also be visualized in Table 1.

### Complications

The rate of complications or conversions in the studies was low, most of them classified as minor complications, grade I, II or III, according to the Clavien-Dindo classification<sup>15</sup> (Figure 1). Erythema was described in one patient; small blistering of the skin, caused by electrocautery was reported in four patients. Seroma needing aspiration in one patient; dorsal lymphocele in one patient; and hematoma needing operation in one patient. Neuropraxia happened in two cases, both temporary. One axillary delayed wound healing was reported. There was partial nipple ischemia in four patients, partial skin flap (not

**Table 1.** Summary of studies data.

Study	Patients	Positioning	Incision	Surgery Time	Oncological Outcomes	Satisfaction	Cost-effectiveness
Toesca et al. <sup>7</sup>	24 patients - 29 breasts: 21 therapeutic; 8 prophylactic RNSM	Flat supine position; arm alongside the body	3 cm on midaxillary line	420 min (first case); 180min (last cases)	No recurrence. 8 months follow-up	High degree*	N/A
Sarfati et al. <sup>9</sup>	33 patients - 63 breasts; 1 therapeutic; 62 prophylactic RNSM	Supine; 90° abduction of the arm	Vertical 3–5 cm + a subcentimeter incision 8–9 cm below, 6–7 cm posterior from the lateral-mammary fold	195 min (first case); 85 min (last cases)	No recurrence. 9 months follow-up	Evaluation in progress	N/A. Reduction of operating time may overcome the issue of operating room efficiency
Lai et al. <sup>10</sup>	33 patients - 39 breasts; 35 therapeutic RNSM	Supine; 90° abduction of the arm	2.5-5 cm oblique axillary incision	287.2 ± 77.43 min (cases 1-13); 235.6 ± 30.69 min (cases 14-39)	No recurrence. Mean 8.6 ± 4.5 months follow-up	N/A	N/A
Houvenaeghel et al. <sup>12</sup>	27 patients - 27 breasts; 27 therapeutic RNSM	Supine, dorsal decubitus, with anteflexion of the arm	Vertical 4-6 cm; on anterior axillary line + incision for trocar inferiorly	372.5 (group 1) 303.4 (group 2) 257.7 (group 3)	N/A	N/A	N/A. Fixed costs and cost of robotic instruments can provide more costs than conventional surgery
Park et al. <sup>13</sup>	1 patient. Therapeutic RNSM	Supine, dorsal decubitus, with anteflexion of the arm	Vertical 6 cm; on anterior axillary line	409 min	No recurrence. 12 months follow-up	N/A	N/A
Rajappa et al. <sup>14</sup>	1 patient. Therapeutic RNSM	Flat supine position; arm at the side of the body	3 cm on midaxillary line	330 min	N/A	N/A	N/A

RNSM: robotic nipple sparing mastectomy; N/A: Not applicable

Summary of technique, oncological outcomes, patient satisfaction and cost effectiveness in the studies analyzed. \* Satisfaction described in study, but no satisfaction questionnaire cited.

involving the nipple) in three patients, and no cases of total NAC necrosis. Infection was reported in three patients, two of which needed revision, resulting in one implant loss in one series<sup>9</sup>. In another, reoperation was necessary for four patients, with three cases of prosthesis explantation<sup>12</sup>. Conversion to open surgery occurred in four cases, due to bleeding of internal mammary perforator (2 patients), malpositioning of incision causing technical problems (1 patient), and in Toesca et al.'s first case, due to long time of surgery (1 patient). Implant rotation was reported for 1 patient, and there was no information on whether the patient was reoperated. Complication events are summarized in Figure 2.

### Oncological outcomes

There were no recurrences in the studies analyzed, with the longer follow-ups in Park et al.'s case report — 12 months —, and in Sarfati et al.'s series of cases — 9 months<sup>9,13</sup>.

### Satisfaction

Despite the surgery's cost and time, the satisfaction of the patient must be evaluated to determine advantages of robotic procedures. None of the studies have objective satisfaction rates published. Toesca et al. describe patient satisfaction as "high degree", but no questionnaires were used<sup>7</sup>. Sarfati et al. used the Breast-Q questionnaire before the procedure, another non-specified satisfaction questionnaire at 6 months, assessing amongst other things the aesthetic result, and the Breast-Q and the satisfaction questionnaire were planned to be used again at 12 months<sup>9</sup>. Data are not yet available.

### Cost-effectiveness

Robotic surgery is usually considered a very expensive procedure because of fixed and of robotic instruments costs<sup>12</sup>. The studies analyzed do not assess cost-effectiveness of RNSM.

## DISCUSSION

In an era where minimal invasive techniques arise and gain popularity, robotic surgery emerges with the proposal of delivering excellence in oncological treatment at the same time as it provides good aesthetic results. According to these recent studies, with short follow-ups, indeed this technique seems to meet its promise.

The question is if it is really worth the price<sup>16</sup>. Robotics is known for its high costs, related initially to the purchase of the da Vinci Surgical System that costs between US\$1 and US\$2.3 million, added to maintenance fees, from US\$100,000.00 to US\$150,000.00 annually. The instrument arms of the robot have a maximum of 10 uses, after which they can no longer be used<sup>17</sup>. Moreover, robotics demands adequate staff training, infrastructure upgrades, and increased operating room time. These costs are, in some cases, offset by shorter hospital stays, less trauma, bleeding and operative complications<sup>18,19</sup>.

In the context of breast surgery, bleeding is not a major problem and patients usually are discharged from hospital in a few days. NSM with immediate breast reconstruction, either with prosthesis or a flap, is one of the largest breast procedures, and for this reason, robotic surgery may be a good alternative.

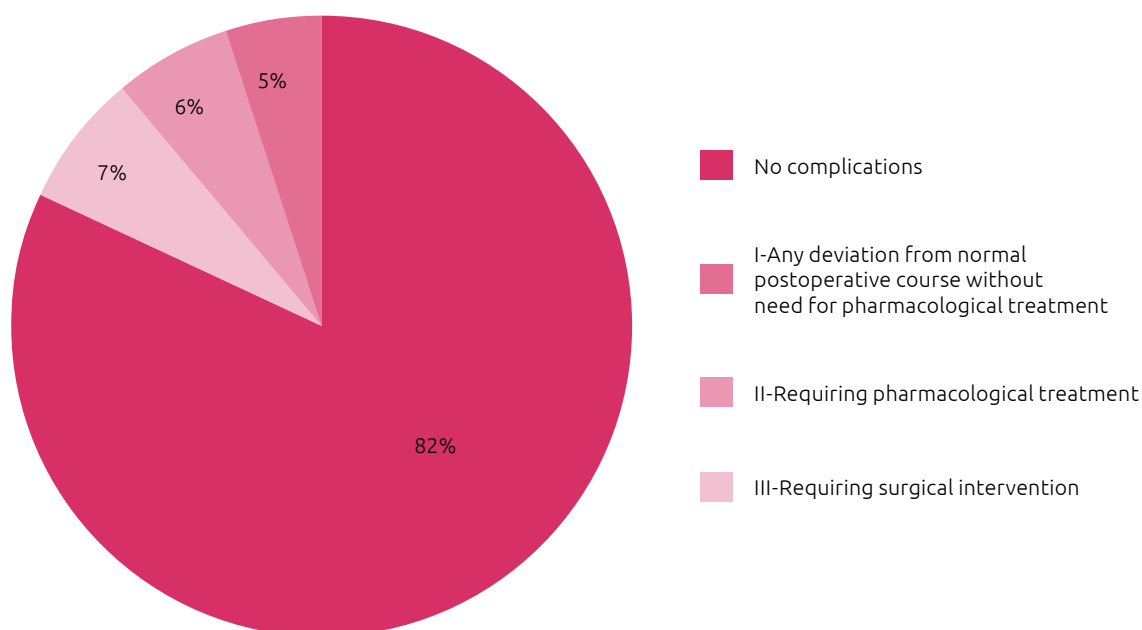

**Figure 1.** Classification of complications in robotic nipple sparing mastectomy, according to Clavien-Dindo grade.

Centers worldwide are studying its safety and feasibility and data on its cost-effectiveness are soon expected.

Earlier this year, Linhares et al. performed the first breast robotic surgery in Brazil at Erasto Gaertner Hospital<sup>20</sup>. Other cases have followed and we soon expect a national publication of their experience.

## CONCLUSIONS

RNSM with immediate reconstruction with breast implant is apparently a safe approach to the removal of the breast gland, but studies have short follow-ups of only a few months. Longer follow-up is necessary to prove oncological safety.

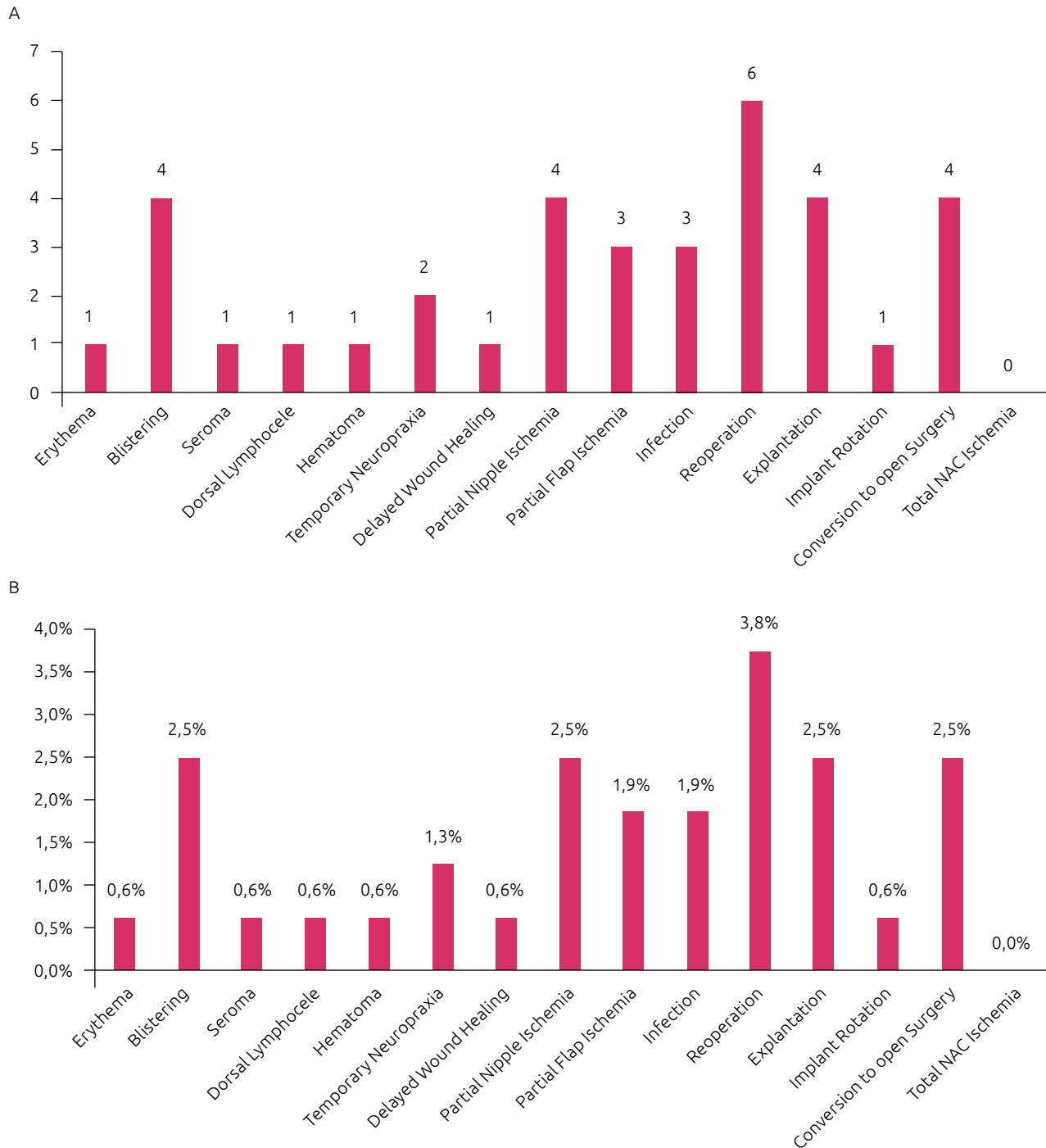

**Figure 2.** Complications of robotic nipple sparing mastectomy (n = 160): (A) expressed in number of events (total complications = 36; no complications = 124); (B) expressed in percentage (total complications = 22,5%; no complications = 77,5%).

Three-dimensional high resolution optics allow excellent dissection planes. Image magnification and intense lighting increase contrast of colors and visibility of structures, making dissection of the gland and recognition of all structures, especially blood vessels, more precise, thus reducing bleeding and preserving circulation to the nipple areolar complex. High precision movement, stability due to tremor elimination, articulation and motion of instruments enable good mobility around the curvature of the breast cupola<sup>7,9,10</sup>.

Complication rates for RNSM are low (23%), mostly minor ones, with only 3% of conversion and 4% of reoperations. Ischemia and necrosis are rare (5%), and no total skin or NAC necrosis were reported.

There are no studies so far that analyze cost-effectiveness for robotic breast surgeries, but the fast learning curve helps to reduce operating room time and consequently the costs. Robotic instruments are known to be expensive, so as maintenance for the robot, but strategies have been proposed to reduce

costs<sup>17</sup> and soon new competitors for the Da Vinci are expected to enter the robotic market<sup>20</sup>.

In the search for increasingly less invasive surgeries, robotics seems to meet what is proposed without compromising oncological safety and keeping up with high-satisfaction aesthetic results. Longer follow-up and cost-effective analyzes will determine if this technique will be consolidated.

## AUTHORS' CONTRIBUTION

P.C. : Conceptualization, Data curation, Formal analysis, Project administration, Writing – original draft.

D.M.P. : Conceptualization; Project administration, Writing – review & editing.

N.C.S.: Conceptualization, Data curation; Writing – review & editing.

J.M.C. : Investigation, Visualization.

F.S.O. : Methodology; Visualization.

## REFERENCES



- Urban C, Lima R, Schunemann E, Spautz C, Rabinovich I, Anselmi K. Oncoplastic principles in breast conserving surgery. *The Breast*. 2011;20(Suppl. 3):S92-S95. [https://doi.org/10.1016/s0960-9776\(11\)70302-2](https://doi.org/10.1016/s0960-9776(11)70302-2)
- Hinton C, Doyle P, Blamey R, Davies C, Holliday H, Elston C. Subcutaneous mastectomy for primary operable breast cancer. *Br J Surg*. 1984;71(6):469-72. <https://doi.org/10.1002/bjs.1800710623>
- Toth B, Lappert P. Modified skin incisions for mastectomy: the need for plastic surgical input in preoperative planning. *Plast Reconstr Surg*. 1991;87(6):1048-53. <https://doi.org/10.1097/00006534-199106000-00006>
- Kroll S, Schusterman M, Tadjalli H, Singletary S, Ames F. Risk of recurrence after treatment of early breast cancer with skin-sparing mastectomy. *Ann Surg Oncol*. 1997;4:193-7. <https://doi.org/10.1007/BF02306609>
- Viegas JF, Lichtenfels M, de Souza ABA, Vollbrecht B, Laitano Neto F, Zerwes FP, et al. Aesthetic outcome and oncological safety of nipple-sparing mastectomy. *Mastology*. 2019;29(1):3-8. <https://doi.org/10.29289/2594539420190000418>
- Leff D, Vashisht R, Yongue G, Keshtgar M, Yang G, Darzi A. Endoscopic breast surgery: where are we now and what might the future hold for video-assisted breast surgery? *Breast Cancer Res Treat*. 2011;125:607-25. <https://doi.org/10.1007/s10549-010-1258-4>
- Toesca A, Peradze N, Manconi A, Galimberti V, Intra M, Colleoni M, et al. Robotic nipple-sparing mastectomy for the treatment of breast cancer: Feasibility and safety study. *The Breast*. 2017;31:51-6. <http://dx.doi.org/10.1016/j.breast.2016.10.009>
- Toesca A, Peradze N, Galimberti V, Manconi A, Intra M, Gentilini O, et al. Robotic Nipple-sparing Mastectomy and Immediate Breast Reconstruction With Implant: First Report of Surgical Technique. *Ann Surg*. 2017;266(2):e28-30. <https://doi.org/10.1097/SLA.0000000000001397>
- Sarfati B, Struk S, Leymarie N, Honart JF, Alkhashnam H, Fremicourt KT, et al. Robotic Prophylactic Nipple-Sparing Mastectomy with Immediate Prosthetic Breast Reconstruction: A Prospective Study. *Ann Surg Oncol*. 2018;25:2579-86. <https://doi.org/10.1245/s10434-018-6555-x>
- Lai HW, Wang CC, Lai YC, Chen CJ, Lin SL, Chen ST, et al. The learning curve of robotic nipple sparing mastectomy for breast cancer: An analysis of consecutive 39 procedures with cumulative sum plot. *Eur J Surg Oncol*. 2019;45(2):125-33. <https://doi.org/10.1016/j.ejso.2018.09.021>
- Sarfati B, Honart J, Leymarie N, Kolb F, Rimareix F. Robotic-assisted Nipple Sparing Mastectomy: A feasibility study on cadaveric models. *J Plast Reconstr Aesthet Surg*. 2016;69(11):1571-2. <https://doi.org/10.1016/j.bjps.2016.08.007>
- Houvenaeghel G, Bannier M, Rua S, Barrou M, Heinemann A, Troy E, et al. Breast cancer robotic nipple sparing mastectomy: evaluation of several surgical procedures and learning curve. *World J Surg Oncol*. 2019;17. <https://doi.org/10.1186/s12957-019-1567-y>
- Park HS, Kim JH, Lee DW, Song SY, Park S, Kim SI, et al. Gasless Robot-Assisted Nipple-Sparing Mastectomy: A Case Report. *J Breast Cancer*. 2018;21(3):334-8. <http://dx.doi.org/10.4048/jbc.2018.21.e45>
- Rajappa SK, Mch RK, Garg S, Ram D. Robotic nipple-sparing mastectomy: The first experience from Indian subcontinent. *The Breast J*. 2018;24(6):1114-5. <https://doi.org/10.1111/tbj.13146>

15. Dindo D, Dermatines N, Clavien PA. Classification of Surgical Complications A New Proposal With Evaluation in a Cohort of 6336 Patients and Results of a Survey. *Ann Surg.* 2004;240(2):205-13. <http://doi.org/10.1097/01.sla.0000133083.54934.ae>
16. Warren H, Dasgupta P. The future of robotics. *Investig Clin Urol.* 2017;58(5):297-8. <http://dx.doi.org/10.4111/icu.2017.58.5.297>
17. Nayeemuddin M, Daley S, Ellsworth P. Modifiable Factors to Decrease the Cost of Robotic-Assisted Procedures. *AORN J.* 2013;98(4):343-52. <https://doi.org/10.1016/j.aorn.2013.08.012>
18. Childers C, Gibbons M. Estimation of the Acquisition and Operating Costs for Robotic Surgery. *JAMA.* 2018;320(8):835-6. <https://doi.org/10.1001/jama.2018.9219>
19. Khorgami Z, Li WT, Jackson TN, Howard A, Sclabas G. The cost of robotics: an analysis of the added costs of robotic-assisted versus laparoscopic surgery using the National Inpatient Sample. *Surg Endosc.* 2019;33:2217-21. <https://doi.org/10.1007/s00464-018-6507-3>
20. Linhares J, Hatschbach S, Tsunoda A, Groth A. To Boldly Go Where No Man Has Gone Before. *Mastology.* 2019;29(1):2-3. <https://doi.org/10.29289/2594539420190000463>





# Histological and molecular classification of breast cancer: what do we know?

Renan Gomes do Nascimento<sup>1\*</sup> , Kaléu Mormino Otoni<sup>2</sup> 

## ABSTRACT

Breast cancer is the neoplasm most diagnosed malignancy and the leading cause of mortality among women on a global scale. A profound increase in the understanding and clinical management of breast cancer has occurred over the past two decades, which has led to significant progress in prevention, early detection, and personalized breast cancer therapy. However, the biggest obstacle still faced in clinical practice is the complete understanding of intertumoral and intratumoral heterogeneity, in addition to the mechanisms of multiple drug resistance in the systemic treatment of the disease. In view of this, many studies focus on analyzing morphological and, mainly, molecular patterns of breast cancer, with the purpose of grouping these tumors into classes or entities to assist in clinical management, in the elaboration of epidemiological and functional studies, and in the performance of clinical trials. The most common special histological types of breast cancer include: medullary carcinoma, metaplastic carcinoma, apocrine carcinoma, mucinous carcinoma, cribriform carcinoma, tubular carcinoma, neuroendocrine carcinoma, classic lobular carcinoma, and pleomorphic lobular carcinoma, in addition to the non-specific type of invasive ductal carcinoma, which constitutes the majority of newly diagnosed cases. As to their molecular aspect, intrinsic subtypes were identified based on global studies of gene expression profiles. Today, four molecular subgroups are widely reproduced and well established in the clinical routine, namely: Luminal A, Luminal B, HER2 +, and Triple Negative. Thus, the present article aims to briefly address the histological and molecular classification of breast cancer.

**KEYWORDS:** breast cancer; classification; neoplasms.

## INTRODUCTION

Cancer has become one of the main causes of morbidity and mortality on a global scale in recent decades, as a result largely due to demographic, economic and epidemiological transitions<sup>1,2</sup>. Among the female population, breast cancer is the most common malignancy in the world (154 out of 185 countries), except in West Africa, where cervical cancer prevailed. In 2018, a total of 2.1 million women were diagnosed with breast cancer, approximately one new case diagnosed every 18 seconds. In addition, breast cancer also represents the highest cancer mortality rates in women across the globe (103 out of 185 countries), with roughly 626,600 deaths due to the disease, with the main exceptions being the countries of Northern Europe, South America North and Sub-Saharan Africa, where the main causes of death were due to cervical and/or lung cancer<sup>2-4</sup>.

In Brazil, according to the latest publication for the 2020–2021 biennium, produced by the National Cancer Institute (INCA),

approximately 66,280 new cases of breast cancer annually, with an estimated risk of 61.61 cases per 100 thousand women. Without considering non-melanoma skin cancer, this type of malignancy is the second most incident in the general population and the most incident among the female population in Brazil, representing 29.7% of all cancer cases in this population, surpassing the world average, estimated at 24.2%<sup>5</sup>. It is known by the scientific community that the morphological and molecular aspects of breast cancer have been thoroughly explored and that these studies sought further clarification of the tumor heterogeneity of breast cancer. Therefore, this article aims to briefly address the current status of the histological and molecular classification of breast cancer. For that to be accomplished, articles were searched in the PubMed database without language restrictions. The search terms “breast cancer” were used in combination with specific terms that cover the different histological and molecular subtypes, as appropriate. We selected publications widely over

<sup>1</sup>Faculty of Medicine, Universidade de São Paulo – São Paulo (SP), Brazil.

<sup>2</sup>ProNutrir Nutritional Support and Chemotherapy – Fortaleza (CE), Brazil.

\*Corresponding author: renanfarmaceutico@outlook.com

Conflict of interests: nothing to declare.

Received on: 04/29/2019. Accepted on: 06/26/2020.

the last five years, and did not exclude older, commonly referenced and highly regarded publications. We also searched the reference lists of articles identified by this search strategy and selected those that we deemed relevant.

## HISTOLOGICAL CLASSIFICATION

For the morphological study of breast cancer, we must understand whether the tumor is limited to the epithelial component of the breast or has invaded the surrounding stroma, and whether this tumor appeared in the mammary ducts or lobes<sup>6</sup>. However, in histopathological practice, cell type characteristics, number of cells, type and location of secretion, immunohistochemical profile and architectural characteristics determine if the tumor is ductal or lobular, in addition to its sub-classifications, rather than its precise location in the mammary tissue<sup>7,8</sup>. About 50% to 80% of newly diagnosed breast cancer cases are called invasive ductal carcinoma (IDC); the rest of the cases are classified as invasive lobular carcinoma (ILC)<sup>9</sup>. IDCs can be classified as “no specific type” because these tumors do not present sufficient morphological characteristics to be determined as a characteristic histological type; they can also be recognized as a “special type” if they present sufficient distinctive characteristics, and particular cellular and molecular behavior<sup>9,10</sup>. The most common special types of breast cancer include: medullary carcinoma, metaplastic carcinoma, apocrine carcinoma, mucinous carcinoma, cribriform carcinoma, tubular carcinoma, neuroendocrine carcinoma, classic lobular carcinoma, and pleomorphic lobular carcinoma<sup>10</sup>.

### Invasive ductal carcinoma no specific type (IDC-NST)

The histological subtype IDC-NST is the most common, constituting about 40% to 75% of all invasive breast carcinomas. Usually, it has a wide scope of morphological variation and clinical behavior<sup>10</sup>. Tumor cells are pleomorphic, with protruding nucleoli and numerous mitoses. Areas of necrosis and calcifications can be detected in more than half of the cases<sup>7,10</sup>.

### Medullary carcinoma

Special subtype of invasive breast carcinoma, responsible for approximately 5% of all cases, and associated with better clinical results and lower rates of involvement in axillary lymph nodes<sup>11</sup>. It usually affects patients between 30 and 40 years old and is often associated with mutations in the BRCA1 germline (*Breast cancer gene 1*)<sup>10</sup>. Microscopically, it is a well-circumscribed carcinoma, composed of large and pleomorphic tumor cells, with a syncytial growth pattern, frequent mitotic figures and prominent lymphoplasmacytic infiltrate (Figure 1A). Other commonly seen features include spindle cell metaplasia and giant tumor cells<sup>12,13</sup>.

### Metaplastic carcinoma

This histological subtype is characterized by the dominant component of metaplastic differentiation, representing approximately 1% of all cases and affecting women, mainly in post-menopause<sup>14</sup>. This group of tumors shows aggressive biological behavior and an often lymph node involvement<sup>15</sup>. Morphologically, it is a poorly differentiated heterogeneous tumor that contains ductal carcinoma cells mixed with other histological elements, such as squamous cells, spindle cells or other mesenchymal differentiation, such as chondroid cells, bone cells, and myoepithelial cells (Figure 1B)<sup>12,15</sup>.

### Apocrine carcinoma

It constitutes about 1% to 4% of all cases, with prominent apocrine differentiation comprising at least 90% of tumor cells<sup>7</sup>. This subtype is generally of high histological grade, with poor prognosis and affects a wide age group, but it is more commonly seen in postmenopausal women<sup>16</sup>. Microscopically, tumor cells are large, with an abundant granular eosinophilic cytoplasm, positive for PAS (*Periodic acid-reactive Schiff*) staining and prominent nucleoli; in addition, bizarre tumor cells with multilobulated nuclei can also be observed (Figure 1C)<sup>12,17</sup>.

### Mucinous carcinoma

It is a special subtype of breast cancer, also known as colloid, gelatinous, mucous and mucoid carcinoma, responsible for 2% of all newly diagnosed cases<sup>11</sup>. This subtype has been associated with a favorable prognosis and often affects women over 60 years of age<sup>18</sup>. Morphologically, these tumors have abundant amounts of extracellular mucin, surrounding small clusters of tumor cells with different growth patterns and with mild nuclear atypia (Figure 1D)<sup>12,19</sup>.

### Cribriform carcinoma

Special subtype associated to a good prognosis, generally affecting patients who are approximately 50 years old and constituting about 1% to 3.5% of all breast cancer cases<sup>6</sup>. Cribriform carcinoma has almost no evidence of regional or distant metastasis<sup>7</sup>. Microscopically, this subtype presents islands of uniform tumor cells, with low-grade atypia, cribriform appearance in 90% of the tumor and often associated with DCIS (*Ductal carcinoma in situ*) without well-defined stromal invasion (Figure 1E)<sup>20</sup>.

### Tubular carcinoma

Well-differentiated subtype, occurring in women between 50 and 60 years of age and constituting about 2% of all newly diagnosed cases<sup>11</sup>. Most tubular carcinomas are associated to a wide range of potentially premalignant proliferative lesions<sup>21</sup>. This subtype is characterized by the proliferation of prominent tubules (> 90%), which can be angled, oval or elongated, with a

disorganized disposition and open lumen covered by a single layer of epithelium, usually without presentation of necrosis and mitosis (Figure 1F)<sup>12,22</sup>.

### Neuroendocrine carcinoma

It constitutes about 0.5% to 5% of all cases of breast cancer and commonly occurs in older ages<sup>10</sup>. This type of tumor has characteristics similar to neuroendocrine tumors of the gastrointestinal tract and lung, consistently expressing the markers chromogranin A and synaptophysin in more than 50% of neoplastic cells<sup>23</sup>. Morphologically, there is an infiltrative growth pattern with solid aggregates of tumor cells arranged in alveolar, trabecular or rosette patterns, and peripheral palisades can also be observed<sup>12</sup>. Neoplastic cells can be of different sizes and generally have fine eosinophilic granular cytoplasm (Figure 1G)<sup>24</sup>.

### Invasive lobular carcinoma

It is the second largest biologically distinct carcinoma, representing about 5% to 15% of all newly diagnosed cases and generally affecting women of advanced age<sup>11</sup>. The classic form of the ILC is characterized by the presence of small tumor cells with little atypia, uniformly distributed throughout the stroma in a concentric pattern (Figure 1H)<sup>10</sup>. Among pleomorphic ILC, tumor cells have a hyperchromatic and eccentric nucleus, prominent mitoses and apocrine. Histiocytic or signet ring cells can be observed (Figure 1I) and they are more likely to have TP53 mutations (*Tumor protein 53*)<sup>25</sup>.

### MOLECULAR CLASSIFICATION

We now know that breast cancer represents a biologically and phenotypically heterogeneous collection of diseases with different clinical and treatment response behaviors<sup>26</sup>. In this era of

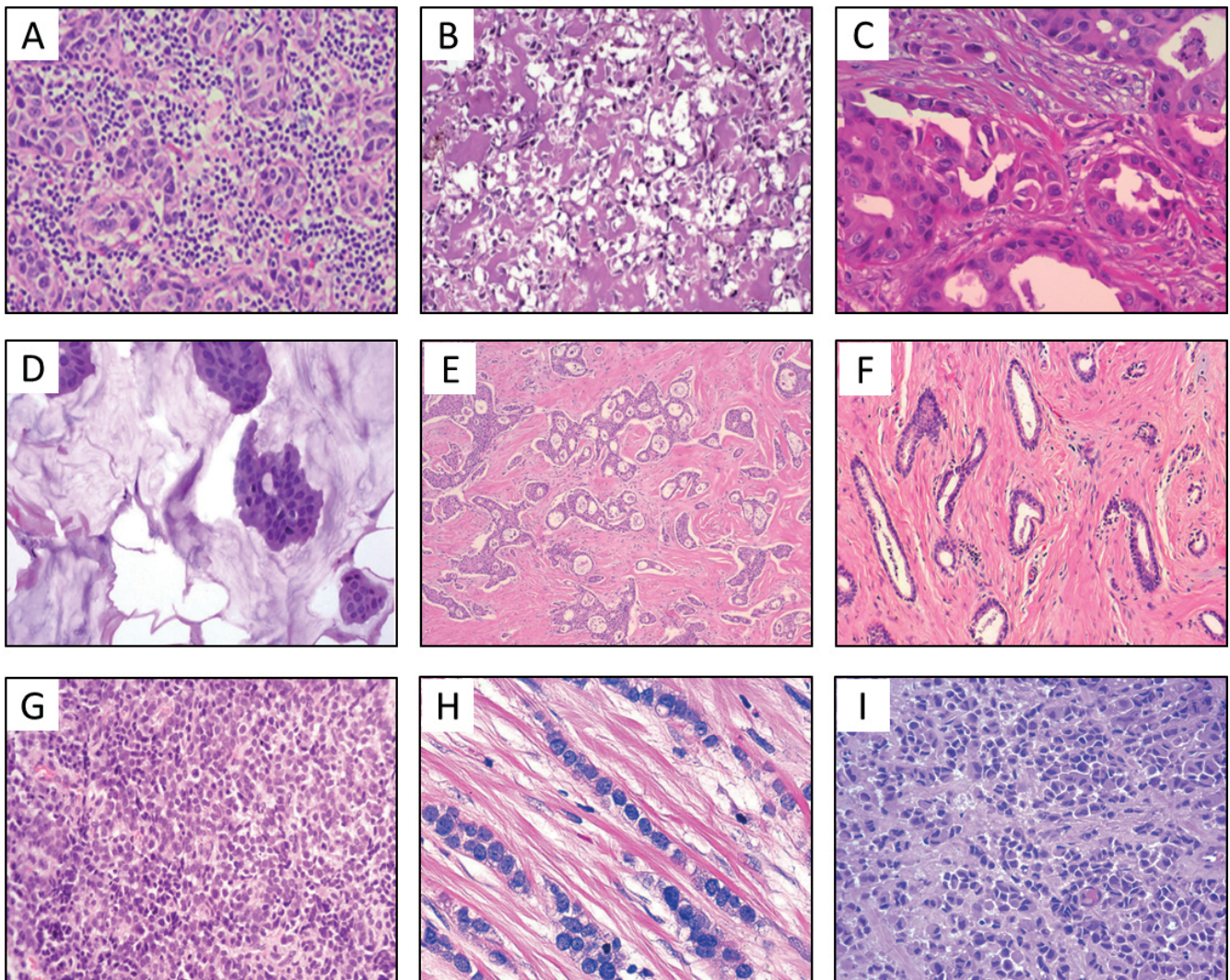

**Figure 1.** Morphological variants representative of the main subtypes of invasive breast carcinomas. (A) medullary carcinoma; (B) metaplastic carcinoma; (C) apocrine carcinoma; (D) mucinous carcinoma; (E) cribriform carcinoma; (F) tubular carcinoma; (G) neuroendocrine carcinoma; (H) classic lobular carcinoma; and (I) pleomorphic lobular carcinoma.

modern medicine, only the morphological classification (nuclear grade, tubular grade, mitotic index, histological grade, and architectural characteristics) and the clinical pathological parameters (tumor size, lymph node involvement, metastasis), are insufficient to predict the real behavior of breast tumor pathophysiology<sup>10,27</sup>. Thus, many studies focus on analyzing the molecular patterns of breast cancer in order to group these tumors into classes or entities to assist in clinical management, in the preparation of epidemiological and functional studies and in the performance of clinical trials<sup>28-34</sup>.

The pioneering work by Perou, Sorlie and colleagues at the beginning of this millennium classified breast cancer molecularly into distinct subgroups, based on similarities in gene expression profiles, using the cDNA microarray technique<sup>31,33,34</sup>. Thus, these studies demonstrated that there are breast cancer subtypes with differences in gene expression patterns, reflecting the individual phenotype, disease prognosis and systemic treatment planning<sup>35</sup>. Based on comprehensive gene expression profile studies, four clinically relevant molecular subtypes were revealed: Luminal A, Luminal B, enriched HER2 (HER2+), and Triple Negative (TN) (36). The groups of genes responsible mainly for the segregation of the molecular subtypes of breast cancer are genes related to the expression of estrogen receptors (ER), progesterone receptors (PR), HER2 (*Human epidermal growth factor receptor 2*), and cell proliferation regulator (Ki-67)<sup>1</sup>. The Immunohistochemical (IHC) panel with these four biomarkers (ER/PR/HER2/Ki-67) has been considered efficient and significant in the stratification of these molecular entities<sup>6,35</sup>. However, the growing need to improve risk stratification and accurate prognosis determination, in addition to an accurate understanding of tumor biology, led to the development of many multigenic assays, such as *Oncotype DX*, *Prosigna PAM50* and *MammaPrint*<sup>36-39</sup>. The signature of 70 genes (*MammaPrint*) and of 21 genes (*Oncotype DX*) are being used in patients with ER+ disease at an early clinical stage to distinguish women who may have the greatest risk of recurrence and

who would benefit from adjuvant chemotherapy<sup>40,41</sup>. The PAM50 trial (*Prosigna*) is a classifier for breast cancer subtypes. It also assesses a patient's risk for distant recurrence of the disease and the likelihood of efficacy of neoadjuvant chemotherapy<sup>40,41</sup>.

Molecular subtyping changed our view of breast cancer, with the possibility of stratifying this neoplasm in different entities that require specific treatments and different monitoring strategies, in addition to a better understanding of the pathophysiological pattern and clinical prognosis. Next, we briefly present the different molecular subtypes of breast cancer.

### Luminal A

This molecular subtype is the most common and comprises approximately half of newly diagnosed breast cancer cases<sup>7</sup>. According to the last update of St. Gallen in 2013, the immunohistochemical profile of this subtype was defined as: ER+ ( $\geq 1\%$ ), high expression of PR ( $\geq 20\%$ ), HER2- ( $\leq 10\%$ ), and low levels of Ki-67 ( $< 14\%$ )<sup>42</sup>. In addition, these tumors have characteristics of luminal epithelial cells of the breast, such as the high expression of cytokeratin's 7/8/18/19<sup>43</sup>. They include a wide range of low histological grade variants, such as IDC-NST, tubular, cribriform, mucinous, and classic ILC<sup>6,43</sup>. This subtype has been associated with a highly favorable prognosis, with a more indolent clinical course, and generally shows less lymph node involvement<sup>44</sup>. Nonetheless, due to the positive status of hormone receptors, patients benefit from endocrine therapies, either with selective estrogen receptor modulators (tamoxifen) or with aromatase inhibitors (anastrozole) (Table 1)<sup>45</sup>.

### Luminal B

Responsible for approximately 20% to 30% of invasive breast cancer cases<sup>26</sup>. This subtype can be categorized immunophenotypically into Luminal B (HER-): ER+ ( $\geq 1\%$ ), PR- or  $< 20\%$ , HER2- ( $\leq 10\%$ ) and high levels of Ki-67 ( $\geq 20\%$ ); or Luminal B (HER2+): ER+ ( $\geq 1\%$ ), HER2+ ( $> 10\%$ ) and any level of PR and

**Table 1.** Classification of molecular subtypes of breast cancer and therapies.

Molecular Subtypes	Luminal A	Luminal B		HER2+	TN
		(HER2-)	(HER2+)		
Biomarkers	ER+ PR+ HER2- Ki67low	ER+ PR- HER2- Ki67high	ER+ PR-/+ HER2+ Ki67low/high	ER- PR- HER2+ Ki67high	ER- PR- HER2- Ki67high
Frequency of Cases (%)	40–50	20–30		15–20	10–20
Histological Grade	Well Differentiated (Grade I)	Moderately Differentiated (Grade II)		Little Differentiated (Grade III)	Little Differentiated (Grade III)
Prognosis	Good	Intermediate		Poor	Poor
Response to Therapies	Endocrine	Endocrine Chemotherapy	Endocrine Chemotherapy Target Therapy	Target Therapy Chemotherapy	Chemotherapy PARP Inhibitors

ER: estrogen receptor; PR: progesterone receptor; HER2: human epidermal growth factor receptor 2.

Ki-67<sup>42,46</sup>. The expression of low molecular weight cytokeratin's from luminal epithelial cells is a rule<sup>26</sup>. This molecular entity generally presents a moderate histological grade, including most of the IDC-NST and associated with an intermediate prognosis, with greater likelihood of locoregional recurrence when compared to Luminal A<sup>44,47</sup>. Luminal B subtype is understood as the most aggressive form of ER+ breast cancer cases and often does not show benefits for hormone therapy (Table 1)<sup>27</sup> (EXCLUDED). Luminal B subtype is understood as the most aggressive form of hormone-dependent breast cancer cases, requiring additional treatments to hormonal therapy, such as chemotherapy (when HER2 +/-) or targeted target therapy (when HER2 +) (Table 1)<sup>27</sup>. The main difference in the molecular aspect between the two luminous subgroups is the increased expression of genes related to cell proliferation, such as NSEPI (*Nuclease sensitive element binding protein 1*) and cyclin E1 (CCNE1), in addition to the activation of certain alternative pathways of growth factors, such as PI3K (*Phosphatidylinositol 3-Kinase*) and Src (*Proto-oncogene sarcoma*) in Luminal B breast tumors<sup>36</sup>.

### HER2+

It represents 15% to 20% of newly diagnosed breast cancer cases<sup>48</sup>. This subtype is characterized by a high expression of HER2 (> 10%), negativity for ER (< 1%) and PR (< 20%), and high expression of Ki-67 (> 20%)<sup>42</sup>. In addition to the immunophenotypic characterization routinely used to assess the status of HER2 in breast cancer, the FISH (*Fluorescence in situ hybridization*) technique has also been employed to assess gene amplification<sup>49</sup>. According to the latest clinical practice guidelines provided by the American Society of Clinical Oncology (ASCO), if the IHC result shows complete staining of the cell membrane with strong marking, the diagnosis is positive for HER2; if staining of low to moderate intensity is observed, it will be necessary to use the FISH assay with an additional observer to confirm positivity, and, finally, in cases with negative marking the complete weak staining of the membrane, the diagnosis can be confirmed as negative for HER2<sup>50</sup>. HER2 overexpression occurs almost exclusively in the ILC pleomorphic variant<sup>27</sup>. The amplification of the gene and the elevated expression of the HER2 protein has been related to tumors of greater histological grade, high proliferative index and propensities to metastasis, leading to short disease-free survival and worse prognosis<sup>26</sup>. However, these tumors may respond well to drugs that block HER2 activity, especially humanized monoclonal antibodies (Trastuzumab) and molecular receptor tyrosine kinase inhibitors (Lapatinib)<sup>35,51</sup>.

### Triple negative

This class of tumors constitutes from 10% to 20% of all breast cancer cases<sup>35</sup>. This subtype is characterized by the lack of expression of the hormone receptors ER (< 1%) and PR (< 20%) and the oncoprotein HER2 ( $\leq$  10%); moreover, they are highly proliferative

tumors, according to the Ki-67 index (> 30%)<sup>42</sup>. Most TN tumors manifest as the IDC-NST histological type. However, they also include variants of medullary, metaplastic and apocrine carcinomas<sup>26</sup>. These tumors are generally more prevalent in patients with BRCA1 mutations and young women, with a higher histological grade, risk of loco-regional recurrence, contralateral disease and systemic relapse<sup>52</sup>. Many gene expression profile studies have been carried out to better understand the heterogeneity of this particularly aggressive form of breast cancer. Thus, TN tumors can be further divided into seven other distinct entities, including two basal-like types (BL1 and BL2), with a basal pattern of gene expression, but showing differences in the immune response; one of the luminal androgen receptor type (LAR), which presents differential expression of genes involved in androgen metabolism; one of the immunomodulatory type (IM), which presents important changes in the expression of genes involved in immunological signaling pathways; one of the claudin-low types (CL), characterized by the low expression of cellular junction proteins (claudins 3, 4 and 7, in addition to E-cadherin); and two of the mesenchymal type, namely, mesenchymal itself (M) and mesenchymal stem-like (MSL), both with positive regulation of the signaling pathways involved in EMT (epithelial mesenchymal transition), but differing in the signaling of genes associated to stem cells and angiogenic factors<sup>29,30,32,53</sup>. Despite its simple definition, this subtype has been a challenge for the clinic, due to its morphological, molecular and clinical heterogeneity and the lack of targeted therapies<sup>54</sup>. Non-surgical treatment of the TN subtype has been limited to platinum-based chemotherapy and PARP (*Poly ADP-ribose polymerase*) inhibitors for patients with BRCA1 and 2 mutations<sup>27,55</sup>.

Although great advances have occurred in high-performance molecular techniques and bioinformatics during the last decades, which allowed refinement in the stratification of breast cancer, molecular tests are still evolving, arising important questions:

- How many subtypes of this malignant neoplasm are there?
- Which molecular classification system is more robust?
- Are the classifications able to illustrate intratumoral heterogeneity and clonal evolution?
- How should we interpret breast cancer subtypes?;
- Is it possible for different classification schemes in clinical practice to exist<sup>56,57</sup>?

These questions will be answered over the next years.

The accumulation of knowledge around cellular and molecular biology, clinical behavior and therapeutic response, added to the emergence of new drugs and new treatment modalities, undoubtedly brought a greater understanding and quality in the management of breast cancer<sup>36</sup>. All the improvements obtained so far are a great achievement for humanity and occurred thanks to the contributions of many researchers around the world<sup>1,58</sup>.

## CONCLUSION

Despite great advances in the stratification of breast cancer subtypes, the greatest obstacle currently found in clinical oncology is the complete understanding of intertumoral heterogeneity (illustrated by tumor size, regional lymph node status, distant metastases and differences in survival), especially the intratumoral heterogeneity (illustrated by histological and biomolecular variability, chromosomal, genomic, metabolic and epigenetic changes, in addition to cellular plasticity and the tumor microenvironment), which impacts the adversity of diagnosis and accurate prognosis, and weakening strategies in personalized medicine. In addition, resistance to multiple drugs (RMD) is considered the biggest obstacle in the systemic treatment of breast cancer, making the disease often uncontrollable and leading to high mortality rates. The mechanisms underlying drug

resistance are still poorly understood. However, anti-apoptotic resistance, ATP-dependent drug efflux pumps, changes in drug targets, epigenetic changes, EMT and miRNAs make up important factors for failures in anti-cancer therapies. In this context, hundreds of other candidates for biomarkers have been investigated and studied for potential implications for diagnosis, prognosis, drug targets and predictor of therapeutic response, “justifying regular reviews”.

## AUTHORS' CONTRIBUTION

R.G.N.: Conceptualization, investigation, methodology, project administration, supervision, validation, visualization, writing – review & editing.

K.M.O.: Formal analysis, investigation, writing – review & editing.

## REFERENCES

- Lukong KE. Understanding breast cancer – The long and winding road. *BBA Clin.* 2017;7(1):64-77. <http://dx.doi.org/10.1016/j.bbaci.2017.01.001>
- Bray F, Ferlay J, Soerjomataram I, Siegel RL, Torre LA, Jemal A. Global Cancer Statistics 2018: GLOBOCAN Estimates of Incidence and Mortality Worldwide for 36 Cancers in 185 Countries. *CA Cancer J Clin.* 2018;68(6):394-424. <https://doi.org/10.3322/caac.21492>
- Ferlay J, Colombet M, Soerjomataram I, Mathers C, Parkin DM, Piñeros M, et al. Estimating the global cancer incidence and mortality in 2018: GLOBOCAN sources and methods. *Int J Cancer.* 2019;144(8):1941-53. <https://doi.org/10.1002/ijc.31937>
- Torre LA, Islami F, Siegel RL, Ward EM, Jemal A. Global cancer in women: Burden and trends. *Cancer Epidemiol Biomarkers Prev.* 2017;26(4):444-57. <https://doi.org/10.1158/1055-9965.epi-16-0858>
- Brasil. Ministério da Saúde. Instituto Nacional de Câncer José Alencar Gomes da Silva. Estimativa 2020: Incidência de Câncer no Brasil. Brasil: INCA; 2019. 120 p.
- Vuong D, Simpson PT, Green B, Cummings MC, Lakhani SR. Molecular classification of breast cancer. *Virchows Arch.* 2014;465(1):1-14. <https://doi.org/10.1007/s00428-014-1593-7>
- Makki J. Diversity of breast carcinoma: Histological subtypes and clinical relevance. *Clin Med Insights Pathol.* 2015;8(1):23-31. <https://dx.doi.org/10.4137%2FCPath.S31563>
- Nounou MI, ElAmrawy F, Ahmed N, Abdelraouf K, Goda S, Syed-Sha-Qhattal H. Breast cancer: Conventional diagnosis and treatment modalities and recent patents and technologies. *Breast Cancer Basic Clin Res.* 2015;9(Suppl. 2):17-34. <https://dx.doi.org/10.4137%2FBBCR.S29420>
- Henry NL, Cannon-Albright L. Breast Cancer Histologic Subtypes Show Excess Familial Clustering. *Wiley Cancer.* 2019;125(18):3131-8. <https://doi.org/10.1002/cncr.32198>
- Masood S. Breast Cancer Subtypes: Morphologic and Biologic Characterization. *Womens Health.* 2016;12(1):103-19. <https://doi.org/10.2217%2Fwhe.15.99>
- Akram M, Iqbal M, Daniyal M, Khan AU. Awareness and current knowledge of breast cancer. *Biol Res.* 2017;50(1):33. <https://doi.org/10.1186/s40659-017-0140-9>
- Provenzano E, Ulaner GA, Chin SF. Molecular Classification of Breast Cancer. *PET Clin.* 2018;13(3):325-38. <https://doi.org/10.1016/j.cpet.2018.02.004>
- Zangouri V, Akrami M, Tahmasebi S, Talei A, Hesaroeeih AG. Medullary breast carcinoma and invasive ductal carcinoma: A review study. *Iran J Med Sci.* 2018;43(4):365-71. <https://doi.org/10.21859/mci-sup-100>
- Sinn HP, Kreipe H. A brief overview of the WHO classification of breast tumors, 4th edition, focusing on issues and updates from the 3rd edition. *Breast Care.* 2013;8(2):149-54. <https://dx.doi.org/10.1159%2F000350774>
- Schwartz TL, Mogal H, Papageorgiou C, Veerapong J, Hsueh EC. Metaplastic breast cancer: Histologic characteristics, prognostic factors and systemic treatment strategies. *Exp Hematol Oncol.* 2013;2(1):31. <https://dx.doi.org/10.1186%2F2162-3619-2-31>
- Vranic S, Schmitt F, Sapino A, Costa JL, Reddy S, Castro M, et al. Apocrine carcinoma of the breast: A comprehensive review. *Histol Histopathol.* 2013;28(11):1393-409. <https://doi.org/10.14670/hh-28.1393>
- Vranic S, Feldman R, Gatalica Z. Apocrine carcinoma of the breast: A brief update on the molecular features and targetable biomarkers. *Bosn J Basic Med Sci.* 2017;17(1):9-11. <https://doi.org/10.17305/bjbms.2016.1811>
- Marrazzo E, Frusone F, Milana F, Sagona A, Gatzemeier W, Barbieri E, et al. Mucinous breast cancer: A narrative review of the literature and a retrospective tertiary single-centre analysis. *Breast.* 2020;49(1):87-92. <https://doi.org/10.1016/j.breast.2019.11.002>
- Dumitru A, Procop A, Iliesiu A, Tampa M, Mitrache L, Costache M, et al. Mucinous Breast Cancer: a Review Study of 5 Year Experience from a Hospital-Based Series of Cases. *Maedica (Buchar).* 2015;10(1):14-8.

20. Cong Y, Qiao G, Zou H, Lin J, Wang X, Li X, et al. Invasive cribriform carcinoma of the breast: A report of nine cases and a review of the literature. *Oncol Lett.* 2015;9(4):1753-8. <https://dx.doi.org/10.3892%2Fol.2015.2972>
21. Zhang WW, Wu SG, Ling YH, Sun JY, Long ZQ, Hua X, et al. Clinicopathologic characteristics and clinical outcomes of pure type and mixed type of tubular carcinoma of the breast: A single-institution cohort study. *Cancer Manag Res.* 2018;10(1):4509-15. <https://dx.doi.org/10.2147%2FCMAR.S177046>
22. Fritz P, Bendrat K, Sonnenberg M, Trautmann C, Ott G, Heidemann E, et al. Tubular breast cancer. A retrospective study. *Anticancer Res.* 2014;34(7):3647-56.
23. Jur i P, Kruslin B, Gatalica Z, Sanati S, Vranic S. Breast carcinoma with neuroendocrine features: a brief review. *Endocr Oncol Metab.* 2016;2(2):138-45. <https://dx.doi.org/10.21040/eom/2016.2.2.6>
24. Li Y, Du F, Zhu W, Xu B. Neuroendocrine carcinoma of the breast: A review of 126 cases in China. *Chin J Cancer.* 2017;36(1):45. <https://dx.doi.org/10.1186%2Fs40880-017-0211-x>
25. Thomas M, Kelly ED, Abraham J, Kruse M. Invasive lobular breast cancer: A review of pathogenesis, diagnosis, management, and future directions of early stage disease. *Semin Oncol.* 2019;46(2):121-32. <https://doi.org/10.1053/j.seminoncol.2019.03.002>
26. Feng Y, Spezia M, Huang S, Yuan C, Zeng Z, Zhang L, et al. Breast cancer development and progression: Risk factors, cancer stem cells, signaling pathways, genomics, and molecular pathogenesis. *Genes Dis.* 2018;5(2):77-106. <https://doi.org/10.1016/j.gendis.2018.05.001>
27. Fragomeni SM, Sciallis A, Jeruss JS. Molecular Subtypes and Local-Regional Control of Breast Cancer. *Surg Oncol Clin N Am.* 2018;27(1):95-120. <https://dx.doi.org/10.1016%2Fj.soc.2017.08.005>
28. Burstein MD, Tsimelzon A, Poage GM, Covington KR, Fuqua SAW, Savage MI, et al. Comprehensive Genomic Analysis Identifies Novel Subtypes and Targets of Triple-negative Breast Cancer. *Clin Cancer Res.* 2015;21(7):1688-98. <https://doi.org/10.1158/1078-0432.ccr-14-0432>
29. Lehmann BD, Bauer JA, Chen X, Sanders ME, Chakravarthy AB, Shyr Y, et al. Identification of human triple-negative breast cancer subtypes and preclinical models for selection of targeted therapies. *J Clin Invest.* 2011;121(7):2750-67. <https://dx.doi.org/10.1172%2FJCI45014>
30. Lehmann BD, Jovanovic B, Chen X, Estrada M V, Johnson N, Shyr Y, et al. Refinement of Triple-Negative Breast Cancer Molecular Subtypes: Implications for Neoadjuvant Chemotherapy Selection. *PLoS One.* 2016;11(6):e0157368. <https://doi.org/10.1371/journal.pone.0157368>
31. Perou CM, Sorlie T, Eisen MB, van de Rijn M, Jeffrey SS, Rees CA, et al. Molecular portraits of human breast tumours. *Nature.* 2000;406(6797):747-52. <https://doi.org/10.1038/35021093>
32. Prat A, Perou CM. Deconstructing the molecular portraits of breast cancer. *Mol Oncol.* 2011;5(1):5-23. <https://dx.doi.org/10.1016%2Fj.molonc.2010.11.003>
33. Sorlie T, Perou CM, Tibshirani R, Aas T, Geisler S, Johnsen H, et al. Gene expression patterns of breast carcinomas distinguish tumor subclasses with clinical implications. *Proc Natl Acad Sci U S A.* 2001;98(19):10869-74. <https://doi.org/10.1073/pnas.191367098>
34. Sorlie T, Tibshirani R, Parker J, Hastie T, Marron JS, Nobel A, et al. Repeated observation of breast tumor subtypes in independent gene expression data sets. *Proc Natl Acad Sci.* 2003;100(14):8418-23. <https://doi.org/10.1073/pnas.0932692100>
35. Tsang JYS, Tse GM. Molecular Classification of Breast Cancer. *Adv Anat Pathol.* 2020;27(1):27-35. <https://doi.org/10.1097/pap.0000000000000232>
36. Harbeck N, Penault-Llorca F, Cortes J, Gnant M, Houssami N, Poortmans P, et al. Breast cancer. *Nat Rev Dis Prim.* 2019;5(1):66. <https://doi.org/10.1038/s41572-019-0111-2>
37. Parker JS, Mullins M, Cheung MCU, Leung S, Voduc D, Vickery T, et al. Supervised risk predictor of breast cancer based on intrinsic subtypes. *J Clin Oncol.* 2009;27(8):1160-7. <https://dx.doi.org/10.1200%2FJCO.2008.18.1370>
38. Paik S, Shak S, Tang G, Kim C, Baker J, Cronin M, et al. A multigene assay to predict recurrence of tamoxifen-treated, node-negative breast cancer. *N Engl J Med.* 2004;351(27):2817-26. <https://doi.org/10.1056/nejmoa041588>
39. Vijver MJV, He Y, Veer L, Dai H, Hart AAM, Voskuil DW, et al. A gene-expression signature as a predictor of survival in breast cancer. *N Engl J Med.* 2002;347(25):1999-2009. <https://doi.org/10.1056/nejmoa021967>
40. Huang S, Murphy L, Xu W. Genes and functions from breast cancer signatures. *BMC Cancer.* 2018;18(1):473. <https://doi.org/10.1186/s12885-018-4388-4>
41. Vieira AF, Schmitt F. An update on breast cancer multigene prognostic tests-emergent clinical biomarkers. *Front Med.* 2018;5(1):248. <https://dx.doi.org/10.3389%2Ffmed.2018.00248>
42. Goldhirsch A, Winer EP, Coates AS, Gelber RD, Piccart-Gebhart M, Thürlimann B, et al. Personalizing the treatment of women with early breast cancer: Highlights of the st gallen international expert consensus on the primary therapy of early breast Cancer 2013. *Ann Oncol.* 2013;24(9):2206-23. <https://dx.doi.org/10.1093%2Fannonc%2Fmdt303>
43. Gao JJ, Swain SM. Luminal A Breast Cancer and Molecular Assays: A Review. *Oncologist.* 2018;23(5):556-65. <https://dx.doi.org/10.1634%2Ftheoncol.2017-0535>
44. Hashmi AA, Aijaz S, Khan SM, Mahboob R, Irfan M, Zafar NI, et al. Prognostic parameters of luminal A and luminal B intrinsic breast cancer subtypes of Pakistani patients. *World J Surg Oncol.* 2018;16(1):1-6. <https://doi.org/10.1186/s12957-017-1299-9>
45. Rocca A, Farolfi A, Maltoni R, Carretta E, Melegari E, Ferrario C, et al. Efficacy of endocrine therapy in relation to progesterone receptor and Ki67 expression in advanced breast cancer. *Breast Cancer Res Treat.* 2015;152(1):57-65. <https://doi.org/10.1007/s10549-015-3423-2>
46. Cheang MCU, Chia SK, Voduc D, Gao D, Leung S, Snider J, et al. Ki67 index, HER2 status, and prognosis of patients with luminal B breast cancer. *J Natl Cancer Inst.* 2009;101(10):736-50. <https://dx.doi.org/10.1093%2Fjnci%2Fdjdp082>
47. Tsoutsou PG, Vozenin MC, Durham AD, Bourhis J. How could breast cancer molecular features contribute to locoregional treatment decision making? *Crit Rev Oncol Hematol.* 2017;110(1):43-8. <http://dx.doi.org/10.1016/j.critrevonc.2016.12.006>

48. Cho N. Molecular subtype and imaging phenotype of breast cancer. *Ultrasonography*. 2016;35(4):281-8. <http://dx.doi.org/10.14366/usg.16030>
49. Desai NV, Torous V, Parker J, Auman JT, Rosson GB, Cruz C, et al. Intrinsic molecular subtypes of breast cancers categorized as HER2-positive using an alternative chromosome 17 probe assay. *Breast Cancer Res*. 2018;20(1):75. <https://doi.org/10.1186/s13058-018-1005-z>
50. Wolff AC, Hammond MEH, Allison KH, Harvey BE, Mangu PB, Bartlett JMS, et al. Human epidermal growth factor receptor 2 testing in breast cancer: American society of clinical oncology/college of American pathologists clinical practice guideline focused update. *J Clin Oncol*. 2018;36(20):2105-22. <https://doi.org/10.1200/jco.2018.77.8738>
51. Llombart-Cussac A, Cortés J, Paré L, Galván P, Bermejo B, Martínez N, et al. HER2-enriched subtype as a predictor of pathological complete response following trastuzumab and lapatinib without chemotherapy in early-stage HER2-positive breast cancer (PAMELA): an open-label, single-group, multicentre, phase 2 trial. *Lancet Oncol*. 2017;18(4):545-54. [http://dx.doi.org/10.1016/S1470-2045\(17\)30021-9](http://dx.doi.org/10.1016/S1470-2045(17)30021-9)
52. Kumar P, Aggarwal R. An overview of triple-negative breast cancer. *Arch Gynecol Obstet*. 2016;293(2):247-69. <https://doi.org/10.1007/s00404-015-3859-y>
53. Sabatier R, Finetti P, Guille A, Adelaide J, Chaffanet M, Viens P, et al. Claudin-low breast cancers: Clinical, pathological, molecular and prognostic characterization. *Mol Cancer*. 2014;13(1):228. <https://doi.org/10.1186/1476-4598-13-228>
54. Russnes HG, Lingjærde OC, Børresen-Dale AL, Caldas C. Breast Cancer Molecular Stratification: From Intrinsic Subtypes to Integrative Clusters. *Am J Pathol*. 2017;187(10):2152-62. <https://doi.org/10.1016/j.ajpath.2017.04.022>
55. Yam C, Mani S, Moulder S. Targeting the Molecular Subtypes of Triple Negative Breast Cancer: Understanding the Diversity to Progress the Field. *Oncologist*. 2017;22(9):1086-93. <https://dx.doi.org/10.1634/theoncologist.2017-0095>
56. Rakha EA, Green AR. Molecular classification of breast cancer: what the pathologist needs to know. *Pathology*. 2017;49(2):111-9. <https://doi.org/10.1016/j.pathol.2016.10.012>
57. Song Q, Merajver SD, Li JZ. Cancer classification in the genomic era: five contemporary problems. *Hum Genomics*. 2015;9(1):27. <https://doi.org/10.1186/s40246-015-0049-8>
58. Ades F, Tryfonidis K, Zardavas D. The past and future of breast cancer treatment - From the papyrus to individualised treatment approaches. *Ecancermedicalscience*. 2017;11(1):746. <https://dx.doi.org/10.3332/ecancer.2017.746>





# Hereditary breast cancer: review and current approach

Cássio Furtini Haddad<sup>1\*</sup> 

## ABSTRACT

Hereditary breast cancer is a complex and important condition, representing about 10% of all breast cancer cases. Identifying high-risk patients and possible carriers of pathogenic genetic variants with indication for genetic testing is an essential step to care for these patients and their families. Treatment can be influenced, both surgical and adjuvant, by the existence of mutation, providing the possibility of better results and preventive measures. In Brazil, access to oncogeneticists and genetic counseling is limited. Mastologists and their teams must be trained to identify and conduct the approach of these patients, with the objective of offering an adequate and preventive care, as well as early diagnostics. In the present study, a literature review of hereditary breast cancer aspects, diagnostic, and implications, in patients with and without breast cancer, was performed, aiming to assist in the proper management offered by mastologists, considering general and Brazilian characteristics.

**KEYWORDS:** breast cancer; genetic testing; heredity; mutation; genetic predisposition.

## INTRODUCTION

Breast cancer (BC) is the most common cancer type affecting women worldwide. In Brazil, the National Cancer Institute (INCA) estimates more than 66,200 new cases for the triennial 2020–2022, corresponding to about 30% of all female cancers.<sup>1</sup>

BC is known to be a heterogeneous disease, with different forms of presentation. Roughly 70% of all cases of BC are classified as sporadic, 20% as familial BC, and 10% as hereditary BC. Most of hereditary breast cancer (HBC) are due to variants in high penetrance genes, with early onset in premenopausal women and with an autosomal dominant heritage pattern. Familial BC has some similar aspects, but it often does not exhibit the dominant autosomal inheritance and the early appearance like in hereditary cases. In HBC, the individual is already born with one of the alleles containing a pathogenic variant, inherited from the father or mother, present in each cell of the body, leading to a greater predisposition to cancer. Most of the breast cancer susceptibility genes are suppressor genes, and there is germline mutation in high or moderate penetrance genes, with a 50% risk of transmitting the genetic alteration to the offspring.

Studies in molecular genetics demonstrate that cancer is a genetic illness due to inherited or acquired DNA mutations, which lead to oncogenes activation and/or suppressor genes inactivation<sup>2</sup>. As mentioned, most BC predisposing genes are tumor suppressor genes, involved in DNA damage repair pathways and cell cycle control: BRCA1, BRCA2, TP53, PTEN, STK11, CDH1, CHEK2, ATM,

BRIP1, and PALB2. Mutations that occur in these genes are loss of function, and cause genomic instability and uncontrolled cell cycle, leading to uncontrolled proliferation of tumor cells<sup>3</sup>.

Carriers of genetic variants of susceptibility to BC are at increased risk of breast cancer and other tumors, both malignant and/or benign, and need to be identified, because this diagnosis has personal and family implications. In addition, HBC is frequently associated to unfavorable prognostic factors, especially in BRCA1-related carcinomas, such as high histological grade, angiolymphatic invasion, presence of basal cytokeratins and negative hormone receptors, which indicate a higher frequency of triple negative tumors when compared to sporadic carcinomas (60%–80% versus 15%–20%)<sup>4</sup>.

Original Knudson model is the most widely accepted for explaining many familial cancers, including breast cancer. With this model, the individual is already born with a genetic variant, and the second event (or second hit) occurs throughout life, usually at a younger age, which may be a mutation in the DNA or another mechanism of gene silencing. In hereditary cancers, the most common is a DNA mutation in the second allele, which may be a pontual mutation or an extensive deletion in the normal allele<sup>5</sup>.

Many aspects of HBC are still unknown. Even after the identification of moderate penetrance genes, a significantly number of patients with high family history for BC have no genetic variant known. Low penetrance genes have also been identified and have uncertain role in the scenario of HBC. Moreover, the same germline genetic mutation can present different forms of presentation

<sup>1</sup>Universidade Federal de Lavras – Lavras (MG), Brazil.  
**\*Corresponding author:** cassiohaddad@hotmail.com  
**Conflict of interests:** nothing to declare.  
**Received on:** 06/20/2020. **Accepted on:** 07/27/2020

(for example, age of onset and tumor characteristics), showing the presence of risk-modifying factors, capable of affecting the penetrancy and the expressiveness of the high-risk genetic variants.

Consequences of diagnosing a genetic mutation of risk for breast cancer should always be discussed before and after testing, involving, whenever possible, a multidisciplinary evaluation and a genetic counseling. Offering genetic counseling is still a complex issue in Brazil because oncogenetics are scarce and concentrated in large cities.

## METHODS

Literature review was conducted by data base from PubMed, Scientific Electronic Library Online (SciELO), and Medical Literature Analysis, and Retrieval System Online (MEDLINE). The search was carried out during April and May 2020, using the terms breast cancer, hereditary breast cancer, genetic testing, hereditary predisposition, BRCA mutation. Articles were selected by their title, year of publication, and scientific evidence. The search was limited to articles published in English. A total of 87 articles were preselected by their abstract or full text, and 64 articles were used to build the present study.

## RESULTS

### Identifying high-risk patients for breast cancer

Identifying high risk patients for BC is an important step in the medical practice. The definition of high risk includes women with a lifetime risk of developing the disease greater than 20%, or a relative risk greater than four or five<sup>6,7</sup>. There are four situations that encompass this definition:

- personal history of atypical ductal hyperplasia or lobular neoplasia (atypical lobular hiperplasia and lobular carcinoma *in situ*);
- irradiation of the chest wall at a young age;
- strong family history without the presence of a genetic variant linked to hereditary cancer;
- carriers of genetic variants linked to hereditary cancer.

Risk measurement can be assessed with clinical history, heredogram, risk prediction models, and genetic testing. BC risk calculation models mostly used in clinical practice and available on the internet are: Tyrer-Cuzick (IBIS Breast Cancer Risk Evaluation Tool; available on <https://www.ems-trials.org/riskevaluator/>), BOADICEA (Breast and Ovarian Analysis of Disease Incidence and Cancer Estimation Algorithm; available on <https://www.ccge.medschl.com.ac.uk>), BRCAPRO (available on <https://www4.utsouthwestern.edu/breasthealth/cagene>) and PENN II (available on <https://pennmodel2.pmacs.upenn.edu/penn2/>)<sup>8-10</sup>. Appropriate personal and family history are essential for guidance on the possibility of hereditary disease. Not every high-risk patient has characteristics of hereditary breast

cancer. Then, assistant professionals must know how to identify high-risk patients to adopt the appropriate management and direct which patients at risk would have an indication for genetic testing.

Another way frequently used to identify a candidate for genetic testing is based on the guidelines of important scientific institutions or societies. Tables 1 and 2 show the National

**Table 1.** National Comprehensive Cancer Network (NCCN) criteria for genetic testing (modified for specific genes and hereditary cancer syndromes) – version 5.2020.

NCCN 2020 – Genetic testing criteria		
Personal history of breast cancer	Age ≤ 45	All patients
	Age 46–50	Unknown family history A second breast cancer at any age
		≥ 1 close relative with breast or ovarian cancer at any age
	Age ≤ 60	Triple negative breast cancer
	Any age	Male breast cancer
		≥ 1 relative with breast cancer with: <ul style="list-style-type: none"> <li>• Breast cancer ≤ 50 years old</li> <li>• Ovarian cancer</li> <li>• Male breast cancer</li> <li>• Prostate cancer Gleason ≥ 7</li> <li>• Pancreatic cancer</li> </ul>
≥ 3 total diagnoses of breast cancer in patient and/or close relatives		
Personal history of others neoplasias	Any age	Ashkenazi Jewish ancestry
		Epithelial ovarian cancer
		Metastatic prostate cancer Gleason ≥ 7
		Pancreatic cancer
Family history of breast cancer		Ashkenazi Jewish ancestry
		Family with known pathogenic or likely pathogenic variant
Personal history or Family history with 3 or more members		1 <sup>st</sup> or 2 <sup>nd</sup> degree relatives with testing criteria
		Breast cancer, sarcoma, central nervous system tumor and leukemia (TP53)
		Colon, endometrial, thyroid, and kidney cancer, signs of Cowden syndrome (PTEN)
		Lobular breast cancer and gastric cancer (CDH1)
Regardless of family history of breast cancer	Any age	Breast, gastrointestinal, pancreatic, and sexual cord cancer, signs of Peutz-Jeghers syndrome (STK11)
		Test with alteration considered eligible for target therapy
		Pathogenic or likely pathogenic variants of BRCA 1 or 2, detected in tumor genetic profile

**Table 2.** Brazilian Supplementary Health National Agency (*Agência Nacional de Saúde Suplementar* - ANS) criteria for genetic testing, 2018.

Hereditary breast and ovarian cancer - GENES BRCA1 and BRCA2 National Supplementary Health Agency		
Coverage	Criteria	
1. Mandatory coverage for women with a current or previous diagnosis of breast cancer when at least one of the following criteria is met:	a. Diagnosis of breast cancer at age $\leq 35$ ;	-
	b. Diagnosis of breast cancer aged $\leq 50$ , and one of the following criteria:	I. a second primary breast tumor (*); II. $\geq$ one family member of 1 <sup>st</sup> , 2 <sup>nd</sup> and 3 <sup>rd</sup> degrees with breast and/or ovarian cancer;
	c. Diagnosis of breast cancer aged $\leq 60$ if triple negative breast cancer (estrogen receptor (ER), progesterone receptor (RP) and HER2 receptor negative);	-
	d. Diagnosis of breast cancer at any age plus one of the following:	I. $\geq$ one family member of 1 <sup>st</sup> , 2 <sup>nd</sup> , and 3 <sup>rd</sup> degrees with female breast cancer aged $\leq 50$ ; II. $\geq$ one family member of 1 <sup>st</sup> , 2 <sup>nd</sup> , and 3 <sup>rd</sup> degrees with male breast cancer at any age; III. $\geq$ one family member of 1 <sup>st</sup> , 2 <sup>nd</sup> , and 3 <sup>rd</sup> degrees with ovarian cancer at any age; IV. $\geq$ two relatives of 1 <sup>st</sup> , 2 <sup>nd</sup> , and 3 <sup>rd</sup> degrees on the same side of the family with breast cancer at any age; V. $\geq 2$ relatives of 1 <sup>st</sup> , 2 <sup>nd</sup> , and 3 <sup>rd</sup> degrees on the same side of the family with pancreatic or prostate cancer (Gleason score $> 7$ ) at any age. (* (*) In the case of bilateral breast cancer or two primary neoplasms in the same breast (confirmed by anatomopathological reports), each of the tumors must be considered independently.
2. Mandatory coverage for women with a current or previous diagnosis of ovarian cancer (epithelial tumor) at any age and regardless of family history.	-	-
3. Mandatory coverage for men with a current or previous diagnosis of breast cancer at any age and regardless of family history.	-	-
4. Mandatory coverage for patients with pancreatic cancer and $\geq$ two relatives of 1 <sup>st</sup> , 2 <sup>nd</sup> , and 3 <sup>rd</sup> degrees on the same side of the family with breast and/or ovarian and/or pancreatic or prostate cancer (Gleason score $\geq 7$ ) at any age.	-	-
5. Mandatory coverage for patients with prostate cancer (Gleason score $\geq 7$ ) and $\geq$ two relatives of 1 <sup>st</sup> , 2 <sup>nd</sup> , and 3 <sup>rd</sup> degrees on the same side of the family with breast and/or ovarian and/or pancreatic or prostate cancer (score of Gleason $\geq 7$ ) at any age.	-	-
6. Mandatory coverage for testing the t founding Ashkenazi mutations in the BRCA1 and BRCA2 genes in patients of Ashkenazi Jewish origin when at least one of the following criteria is met:	a. breast cancer at any age and regardless of family history; b. ovarian cancer at any age and regardless of family history; c. pancreatic cancer at any age with $\geq$ one family member of the 1 <sup>st</sup> , 2 <sup>nd</sup> , and 3 <sup>rd</sup> degrees with breast, ovarian, pancreatic or prostate cancer (Gleason score $\geq 7$ ).	-

Continue...

Table 2. Continuation.

Hereditary breast and ovarian cancer - GENES BRCA1 and BRCA2 National Supplementary Health Agency		
Coverage	Criteria	
7. Mandatory coverage for patients over 18 years old, diagnosed or not with cancer, regardless of gender, when there is a deleterious mutation in BRCA1 or BRCA2 in a family member of 1 <sup>st</sup> , 2 <sup>nd</sup> , and 3 <sup>rd</sup> degrees.	-	-
8. Mandatory coverage for individuals with isolated breast cancer, who have a limited family structure. Limited family structure is the absence, in at least one of the branches (maternal or paternal) of the family, of at least two women from the 1 <sup>st</sup> , 2 <sup>nd</sup> , or 3 <sup>rd</sup> grades who have lived beyond 45 years of age at the time of the assessment. This description includes individuals who are unaware of their biological family data.	-	-
9. Mandatory coverage for individuals with breast cancer, but with limited family structure (absence of two female of 1 <sup>st</sup> , 2 <sup>nd</sup> , or 3 <sup>rd</sup> degree relatives in one of the strains - maternal or paternal - who has lived beyond 45 years of age). Analysis method used in a staggered way:	1. In cases in which the genetic mutation has already been identified in the family, perform only the search for the specific mutation. For patients of Ashkenazi Jewish origin in which the family mutation is a founding mutation, it is justified to carry out the analysis of the three Ashkenazi founding mutations instead of analyzing only the family mutation, because of the possibility of more than one mutation in BRCA genes in Ashkenazi families. If the family is of Ashkenazi Jewish origin and the family mutation is not one of the three founding mutations, it is still justified to test these three mutations in addition to the mutation that is known to secrete into the family; 2. In the cases of patients listed in items 1, 2, 3, 4, 5, 6, and 8, perform the New Generation Sequencing exam for the entire coding region of BRCA1 and BRCA2, and MLPA of BRCA1 and BRCA2; 3. In the case of patients included in item 6, perform the test of the three Ashkenazi founding mutations in the BRCA1 and BRCA2 genes, namely: BRCA1 185delAG (c.66_67delAG, p.Glu23fs), BRCA1 5382insC (c.5263insC, p.Gln1756fs), and BRCA2 6174delT (c.5946delT, p.Ser1982fs). If none of these mutations are identified and other eligibility criteria are met as described in items 1, 2, 3, 4, 5, 7, and 8, the analysis should be performed following the step analysis criteria described for each item.	-

Comprehensive Cancer Network (NCCN) and the Brazilian National Supplementary Health Agency (*Agência Nacional de Saúde* - ANS) criteria for genetic testing, respectively.

Recently, the American Society of Breast Surgeons (ASBS) reviewed its consensus guidelines and recommended that genetic

testing should be available to all patients with a personal history of BC. Recommendations were based on identification of pathogenic genetic variants as influencing patient management in terms of high-risk screening and risk-reduction approach, as well as specific therapeutics options related to surgery,

radiotherapy, and systemic treatment<sup>11</sup>. Moreover, Beitsch et al., in a multicenter prospective registry study with 959 patients, concluded that approximately 45% of patients with BC with clinically actionable germline variants are left out when testing is restricted to patients meeting current NCCN guidelines and when testing strategies are limited to panels containing only BRCA1/2<sup>12</sup>.

### Genetic tests for hereditary predisposition to cancer

Genetic tests to identify BC susceptibility genes are indicated when there is clinical suspicion, usually after heredrogram, risk prediction models, or specific guidelines. Before testing, patients need to be made aware of the implications that test results can have (pre-test counseling). When results become available, patients should be reminded of these implications and be provided the appropriate clinical context for the results to make informed decisions (post-test counseling). All genetic testing should be performed in the setting of informed consent. Knowing that not all carriers of pathogenic genetic variants will develop BC is also important. On the other hand, a negative test result does not necessarily imply the absence of risks.

In general, when family history is suggestive, the best scenario is to test the individual with a cancer diagnosis, because this increases the probability of a positive result. For multiple affected individuals, the preference is to start testing the youngest individual.

Genetic testing for germline variants can be done with a blood sample (analyzing leukocyte DNA samples) or an oral mucosa/saliva sample (analyzing epithelial cells).

In practice, three main types of tests are used: the first generation of genetic sequencing using the Sanger technique was considered the gold standard for research pontual mutations for a long time. It is an accurate, but laborious and expensive method, that needs large amounts of DNA and examines individual fragments of the gene of interest to a single patient at a time<sup>13</sup>. Its limitation is not detecting large rearrangements in DNA. Secondary analysis found that 6%–18% of individuals who are BRCA mutation negative by this technique can be explained by large insertions and deletions in the BRCA1 and BRCA2 genes, detected using other new technology<sup>14</sup>. Currently, its use is restricted to situations in which a certain mutation in the family is already known and has the desire to research it. The Next Generation Sequency (NGS) technique can analyze multiple genes simultaneously, which optimizes costs and is the current preference. However, it has a low sensitivity for large insertions/deletions and can found an expressive finding of variants of uncertain significance (VUS)<sup>15,16</sup>. These multigenic panels can encompass high and moderate penetration genes. NGS has been recently updated to detect copy numbers alterations (CNA), with highly confident detection rates. Another technique is the Multiplex Ligation-dependent

Probe Amplification (MLPA), a multiplex PCR method developed to detect abnormal copy numbers of different genomic DNA sequences, not rarely used to complement diagnostic research and identify major deletions, especially in BRCA1, BRCA2, and TP53 genes. Most of the pathogenic genetic variants in the BRCA genes are punctual and detected by the Sanger technique or NGS multigenic panels, but data show up to 12% of changes in these genes are due to deletions detected by MLPA<sup>17</sup>.

Currently, most genetic studies are carried out by multigenic panels with NGS platforms, complemented, when needed, by the MLPA technique, mainly in cases of strong family suspicion and negative panel results.

The possible results of a genetic test are:

- class 1: benign variant;
- class 2: likely benign variant;
- class 3: variant of uncertain significance (VUS);
- class 4: likely pathogenic variant;
- class 5: pathogenic variant.

Table 3 shows the genetic testing results and interpretation. VUS should always be reported and periodically reassessed. Most VUS will be reclassified into benign or likely benign categories.

### Hereditary breast cancer susceptibility genes

Genetic biomarkers of cancer risk can be categorized into two primary criteria: penetrance and population frequency. Penetrance refers to the estimate that a specific condition, in this case cancer, will occur in the presence of a specific genotype. It refers to the probability, in percentage, to express typical phenotypes at specific timepoints.

The Human Genome Variation Society (HGVS) developed an internationally accepted nomenclature that recommends the use of the neutral term variant rather than mutation. Risk variants mostly show an inversely proportional impact, from very rare ones, with high penetrance, to the common low-risk single nucleotide variants, with high allele frequency (of up to 50%):

**Table 3.** Results and interpretation of genetic testing for cancer predisposition.

Result	Interpretation
True positive	Carrier of a cancer predisposition variant that is already known and present in the family.
True negative	Individual does not carry a known cancer predisposing gene that has been identified in another family member.
Indeterminate	Individual does not carry a known gene for cancer predisposition and the status of another family member is unknown.
Inconclusive (VUS)	Carrier of a mutation in a gene that currently has unknown clinical significance.

VUS: variants of uncertain significance.

- High-risk variants: very rare in the population with a minor allele frequency < 0.005. The conferred relative risk of breast cancer is higher than 4;
- Moderate-risk variants: rare, with a minor allele frequency of 0.005–0.01. Pathogenic variants confer a relative risk of 2–4;
- Low-risk variants: minor allele frequency > 0.01, and conferred risk of breast cancer of less than 1.5-time<sup>18</sup>.

The number of cases in which BC resulted from genetic polymorphisms and genes with low-penetrance (regarding environmental interactions) is considerably larger than the number of BC cases resulted from mutations of high penetrance genes. In the HBC scenario, most cases are due to BRCA1 and BRCA2 variants, whereas others genes are responsible for about 40% of all cases (Figure 1).

## High-penetrance genes

### *BRCA1 and BRCA2*

The first major gene associated to HBC was the BRCA1, located on chromosome 17q21, and identified in 1990 with linkage analysis in families with suggestive pedigrees<sup>19</sup>. In 1994, BRCA2 gene, located on chromosome 13q12-13, was also identified. They have an autosomal dominant inheritance pattern.

BRCA1 and BRCA2 (BRCA1/2) mutations confer a very high life-time risk of BC in the range of 50%–85% for BRCA1, and up to 45% for BRCA2<sup>20</sup>. The risk of ovarian cancer (OC) is also higher: 30%–60% for BRCA1, and 10%–25% for BRCA2 carriers<sup>21</sup>. A greater incidence of other cancers is documented such as prostate, pancreatic, fallopian tube, and primary peritoneal adenocarcinoma for both BRCA1/2 genes, and male BC and melanoma for BRCA2 gene.

Most BRCA1-related breast cancers have a basal-like phenotype and they are also characterized by the lack of expression of estrogen-receptors, progesterone-receptors, and of no over-expression of human epidermal growth factor 2 (triple negative BC). In addition, over-expression of the epidermal growth

fator receptor (EGFR) has been associated to BRCA1-related breast cancers<sup>22</sup>. The immunophenotype and gene expression profile of BRCA2-related cancers are very similar to sporadic breast cancers, with a predominance of positive hormone receptor tumors (luminal BC). Both BRCA1 and BRCA2 tumors exhibit a higher histological grade; BRCA1 tumors are more often poorly differentiated (Grade 3), whereas BRCA2 tumors more frequently are moderately or poorly differentiated (Grades 2 and 3)<sup>23</sup>. The majority of BRCA1 and BRCA2-associated ovarian cancers are classified as high-grade serous carcinomas.

In terms of surveillance, an annual breast nuclear magnetic resonance (MRI) in conjunction with annual mammography screening in BRCA1 and BRCA2 carriers from the age of 30 years is more sensitive than annual mammography alone, detecting BC at an earlier stage<sup>24-26</sup>. Moreover, lifestyle changes and risk reduction strategies should be discussed. Trials involving chemoprevention with Tamoxifen 20 mg once a day for five years have demonstrated that BC risk can be reduced by 40%–50% in women at high risk, although not necessarily in pathogenic variant carriers<sup>27</sup>. Whereas BRCA1 BC are predominantly estrogen receptor (ER) negative and BRCA2 BC are predominantly ER positive, and considering that data are limited regarding the benefit of Tamoxifen in BRCA carriers, Tamoxifen use may be an option for patients who do not want to undergo risk-reducing surgery<sup>28,29</sup>. Risk-reducing bilateral mastectomy should be discussed, and literature shows more than 90% reduction in the BC incidence<sup>30</sup>. A recent study showed that bilateral risk-reducing mastectomy in mutation carriers had an impact on mortality in BRCA1 carriers, although the impact in BRCA2 carriers was less evident<sup>31</sup>. Nipple-sparing mastectomy is a safe and appropriate technique to be evaluated, according to breast size, tumor localization, and degree of ptosis. In addition, prophylactic salpingo-oophorectomy (PSO) confers a 72%–88% risk reduction in OC and fallopian tubal cancer. Literature data show PSO confers a reduction in OC-specific and all-cause mortality in BRCA carriers<sup>31-33</sup>. Therefore, PSO is recommended for BRCA carriers who have completed childbearing, and it should be performed by age 35–40 in BRCA1 carriers, and by age 40–45 in BRCA2 carriers<sup>31</sup>. Early surgical castration causes early menopause and increases the risk of cardiovascular disease and osteoporosis. On the basis of available data from observational studies, hormone replacement therapy after PSO should not be performed in patients affected by BC, but it has not shown an increased risk of BC among cancer-free BRCA carriers who have undergone risk-reduction bilateral mastectomy<sup>34</sup>.

After a BC diagnosis, surgical approach must be individualized and well debated with patients. According to the recent guidelines by the American Society of Clinical Oncology (ASCO), American Society for Radiation Oncology (ASTRO), and Society of Surgical Oncology (SSO) both breast conservative therapy (BCT) and mastectomy are possible<sup>35</sup>. Observational studies suggest

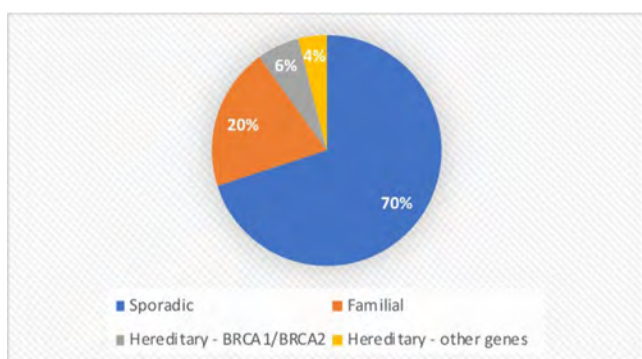

**Figure 1.** Breast cancer classification by cause.

BCT is a safe surgical option for managing BC in BRCA carriers. However, BRCA 1/2 carriers should be informed about the risk of contralateral breast cancer (CBC) and a possible increased risk of a new primary cancer in the ipsilateral breast when compared to noncarriers. Cumulative CBC risk 20 years after a first primary BC is 40% for BRCA1 and 26% for BRCA2 carriers. Current evidence suggests that contralateral risk-reducing mastectomy is effective for BRCA1 carriers, reducing mortality<sup>32,36</sup>. The benefit of contralateral prophylactic mastectomy depends, however, on the previous or current tumor prognosis, age of patient and clinical conditions for the procedure. Recently, van den Broek et al, when comparing BCT *versus* mastectomy in BRCA mutation carriers to noncarriers, found low local recurrence rates, similar overall survival, and no difference in local recurrence rate<sup>37</sup>.

Radiotherapy-related toxicity in patients with breast cancer with BRCA1/2 variants showed that rates of radiation-associated complications in women with BRCA1/2 variants were comparable to rates observed in women with sporadic breast cancer<sup>38,39</sup>.

Two phase III trials (OlympiAD and EMBRACA) randomly assigned patients after chemotherapy in HER2-negative, BRCA-associated metastatic BC, and showed longer progression-free survival with PolyADP-Ribose Polymerases (PARP) inhibitor<sup>40,41</sup>. The Food and Drug Administration has approved 2 PARP inhibitors (Olaparib and Talazoparib) for germline BRCA-associated metastatic BC. In Brazil, Olaparib was approved in this setting by the Brazilian Health Regulatory Agency (*Agência Nacional de Vigilância Sanitária - ANVISA*) in 2018<sup>42</sup>.

### TP53

One of the most studied tumor suppressor gene is the tumor protein 53 (TP53), located on chromosome 17p13.1. Inherited TP53 mutations are associated to the rare autosomal dominant disorder, the Li Fraumeni Syndrome (LFS). Female variant carriers have a nearly 100% lifetime risk of cancer compared to 73% for males, difference which is caused by BC<sup>43</sup>. Unlike other high-risk genes that mostly display risk associated to truncating mutations, genotype–phenotype analysis in LFS families has revealed that germline missense mutations are more frequent. Other than breast cancer in women, TP53 variant carriers are at increased risk of early-onset and multiple primary cancers, including sarcomas, brain, and adrenocortical tumors. Lymphoma, leukemia, melanoma, lung, pancreatic, prostate, and ovarian cancers also seem to be more frequent. Childhood-onset tumors exist, and the most common are brain tumors, followed by sarcomas<sup>44,45</sup>.

In Brazil, because of the founder variant present in a significant part of the population, especially in the Southern region, appropriate investigation and management are therefore important. Recently, a TP53 mutation called p.R337H is drawing the attention of professionals who deal with breast cancer, as it has been identified in a significant portion of patients<sup>46</sup>.

Carriers of a TP53 pathogenic variant should receive intensive surveillance. Breast MRI should be offered annually from age 20, as well as mammography after age 30. Risk-reducing bilateral mastectomy in patients without BC and contralateral risk-reducing mastectomy in patients with BC should be suggested<sup>43</sup>.

TP53 gene may be the most critical tumor suppressor gene in preventing the development of cancer. It plays an important role in cell cycle control and apoptosis, and provides the cell with the ability to respond to and repair DNA damage after cellular stress by triggering multiple downstream repair pathways. Thus, carriers of a TP53 variant would be expected to be unable to repair tissue damage from DNA-damaging RT and be at risk for significant RT-associated sequelae. For these reasons, there is limited evidence to inform the clinical question of the role of RT in women who carry a TP53 mutation. Outcomes reported in published case reports support this recommendation against RT in women with breast cancer who carry a TP53 variant<sup>47,48</sup>. Thus, mastectomy is the recommended therapeutic option.

Based on Toronto protocol, whole-body MRI and brain MRI should be performed at the first preventive clinical screening evaluation in TP53 carriers of pathogenic germline variants, because of the high risk of sarcomas and central nervous system, adrenocortical, and other tumors<sup>49</sup>. However, due to the Brazilian social and economic reality, and the limited access of most citizens to these technologies, feasibility of this recommendation is hard to be adopted.

### PTEN

Cowden syndrome is a rare condition caused by germline mutations in tumor suppressor gene PTEN, located on chromosome 10q23.31. Studies of carriers of disease-causing variants show a considerably high lifetime risk of breast cancer, with low age of onset. Carriers are also at an increased risk of several other malignancies, especially thyroid and endometrial cancer. The syndrome is otherwise characterized by multiple hamartomas of the gastrointestinal tract, macrocephaly, and benign tumors, such as lipomas<sup>50</sup>.

Surveillance with clinical breast examination since age 25, and annual MRI and mammography starting between 30 and 35 years of age is recommended. Risk-reducing mastectomy is controversial, but it can be considered due to the risk of up to 85% by the age of 75 in women<sup>51</sup>.

### CDH1

The CDH1 gene, located on chromosome 16q22.1, encodes a protein responsible for cell-to-cell adhesion and functions as a cell invasion suppressor<sup>52</sup>. E-cadherin germline mutations are responsible for hereditary diffuse gastric cancer (HDGC). Carriers of truncating variants are at a very high risk of diffuse

gastric carcinoma at young age and, in addition, an estimated relative risk of breast cancer of 6.6 (predominantly lobular breast cancer)<sup>53</sup>. Recent studies have provided evidence of lobular breast cancer as the first manifestation of HDGC. Deleterious CDH1 mutations have been identified in women with bilateral lobular breast cancer without a family history of diffuse gastric cancer. The risk of colorectal cancer also appears to be increased<sup>54</sup>.

MRI screening, in women with or without mammography, started at 30 years of age, is the current recommendation for CDH1 mutation carriers. Although evidence is limited, prophylactic mastectomy can be discussed, especially when a family history of BC is present<sup>55</sup>.

Prophylactic partial gastrectomy can be indicated as a preventive measure, given that the risk of gastric cancer reaches 67% in men and 83% in women<sup>56</sup>.

### STK11

The tumor suppressor STK11, located on chromosome 19p13.3, is another gene with a gene product important for cell cycle regulation and mediation of apoptosis. Deleterious mutations cause Peutz–Jeghers Syndrome, characterized by intestinal hamartomatous polyps and mucocutaneous pigmentation. In addition, the lifetime risk of breast cancer by 60 years old is 32%–54%<sup>57</sup>. Other associated tumors with markedly elevated risk are cancers of gastrointestinal origin and pancreatic cancer. Female carriers are also at an increased risk of ovarian sex cord-stromal tumors and a rare tumor of the cervix, the adenoma malignum. Carriers of STK11 mutations have a cumulative lifetime risk of any cancer of up to 85%<sup>57</sup>.

Breast clinical examination associated to MRI and mammography from the age 25 is recommended<sup>58</sup>. Prophylactic mastectomy, oophorectomy, and hysterectomy are controversial procedures, but they can be discussed individually<sup>59</sup>.

### Moderate penetrance genes

Studies have identified several additional DNA repair genes that interact with BRCA genes and confer an approximate two-fold increase in BC risk, including CHEK2, ATM, and PALB2<sup>60</sup>. NBN and NF1 genes are also genes of moderate penetration with increased risk of breast cancer<sup>61</sup>. Recently, BARD1, RAD51D, and MSH6 were identified as moderate-penetrance genes.

The lifetime risk of BC associated to a variant in PALB2 is approximately from 35% to 60%, whereas with ATM and truncating CHEK2 mutations lifetime risk is from 25% to 30%<sup>62</sup>. In a meta-analysis, loss-of-function PALB2 variants have yielded a combined estimated relative risk for BC of 5.3 in carriers of pathogenic mutations, which suggests that PALB2 should, instead, be possibly placed in the high-risk category<sup>63</sup>.

According to the recent guidelines by ASCO, ASTRO, and SSO moderate genes mutation carriers should undergo high-risk breast

screening with annual MRI and mammogram. Mutation status alone should not determine local therapy decisions, and BCT should be offered when it is an appropriate option. Evidence regarding contralateral BC is limited. Contralateral prophylactic mastectomy decision should not be based predominantly on mutation status<sup>35</sup>.

## DISCUSSION

The identification of high-risk patients for BC is crucial for the current clinical management. Likewise, suspecting patients liable to carry a hereditary genetic mutation at risk for BC and other neoplasms has become an important measure in health-care, with personal and family impacts. Considering that roughly 10% of BC cases are hereditary, one in 10 cases have an inherited genetic component to be detected. Worldwide, there is a sub-identification of cancer susceptibility mutations. Population-based approaches to genomic screening remain costly and involve challenges in high through-put sequencing, obtaining informed consent, correct interpretation of genomic variants, and post-test implications<sup>64</sup>.

In Brazil, the limitation of access to oncogeneticists and genetic tests is a real issue and clearly needs improvement. There is an evident gap in this assessment, especially in the public health system, but also in supplementary health. Access to genetic test must involve a multidisciplinary team, with pre and post-test counseling and individual discussion case-by-case, both in the positive and negative scenario for genetic mutation. HBC approach involves integration between indication, application, and understanding of germline testing. For this, based on the ASBS recommendations on its last consensus guidelines, the training and betterment of mastologist doctors should be encouraged<sup>11</sup>. Cancer genetics knowledge allows mastologists to initiate and guide genetic testing for their patients. Strategies related to public awareness, education, integrated services, telemedicine, and multidisciplinary approach are needed.

An appropriate screening strategy and the discussion of risk-reducing measures must be offered. Any patient found to have a hereditary predisposition for BC should be informed of all options to reduce their risk: lifestyle changes, chemoprevention, and risk-reducing surgeries.

The recent guidelines by ASCO, ASTRO, and SSO brought an updated guide for both HBC driving and management. According to it, evidence support prophylactic mastectomy for BRCA1, BRCA2, and TP53 mutation carriers<sup>35</sup>. For the other high penetration genes, evidence is poor, with no clear basis for prophylactic surgery, as well as for moderate penetrance genes<sup>35</sup>. Surgical management of BC in a pathologic variant carrier must consider age, clinical condition, staging at diagnosis and can include both BCT and mastectomy with oncological safe. However, the risk of a new primary tumor



in the breast treated with conservative surgery appears to be greater. Contralateral mastectomy is an option, especially for the therapeutic mastectomy candidates, and should be considered according to the prognostic associated to the primary cancer. Likewise, RT is safe and an important adjuvant treatment, except in those with TP53 variant, in which the risk of radio-induced tumors is high<sup>35</sup>. Finally, in the systemic treatment, evidence suggest that for germline BRCA1/2 mutation carrier with metastatic BC, platinum chemotherapy is preferred rather than taxane therapy for patients who have not previously received platinum. There are no data to address platinum efficacy in other germline mutation carriers<sup>35</sup>. For BRCA1/2 mutation carriers with metastatic HER2-negative BC, Olaparib or Talazoparib (oral drugs) should be offered as an alternative to chemotherapy in the first- to third-line settings. In Brazil, Olaparib is approved by ANVISA since 2018. For BRCA1/2 mutation carriers with metastatic HER2-negative

BC, there are no data directly comparing efficacy of PARP inhibitors to platinum chemotherapy<sup>35</sup>.

## CONCLUSIONS

HBC is still a complex disease, with a wide field of approach to be explored, from the suspicion and identification of individuals and families with pathogenic variants, with the adoption of risk-reducing measures and specific therapies in those who develop cancer. Strategies to improve this identification must be developed, refined, and disseminated.

Mastologists and their multidisciplinary team must be trained in the approach of HBC to facilitate the access of carriers to educational and investigative processes.

The appropriate treatment after the diagnosis of an HBC can offer better results and be cost-effective in terms of disease control and preventive measures.

## REFERENCES

1. Brasil. Ministério da Saúde. DATASUS. Estatísticas vitais [Internet]. Brasília: Ministério da Saúde; 2020 [accessed on May 1, 2020]. Available at: <https://www.inca.gov.br/numeros-de-cancer>
2. Levine EG, King RA, Bloomfiel CD. The role of heredity in cancer. *J Clin Oncol*. 1989;7(4):527-40. <https://doi.org/10.1200/jco.1989.7.4.527>
3. Walsh T, King MC. Ten genes for inherited breast cancer. *Cancer Cell*. 2007;11(2):103-5. <https://doi.org/10.1016/j.ccr.2007.01.010>
4. Kenney MG, Couch FJ, Visscher DW, Lindor NM. Non-BRCA familial breast cancer: review of reported pathology and molecular findings. *Pathology*. 2017;49(4):363-70. <https://doi.org/10.1016/j.pathol.2017.03.002>
5. Maxwell KN, Wubbenhorst B, Wenz BM, De Sloover D, Pluta J, Emery L, et al. BRCA locus-specific loss of heterozygosity in germline BRCA1 and BRCA2 carriers. *Nat Commun*. 2017;8(1):319. <https://doi.org/10.1038/s41467-017-00388-9>
6. National Cancer Institute. Portal [Internet]. NCI; 2019 [accessed on May 1<sup>st</sup>, 2020]. Available at: <http://www.cancer.gov>
7. Constantino JP, Gail MP, Pee D, Anderson S, Redmond CK, Benichou J, et al. Validation studies for models projecting the risk of invasive and total breast cancer incidence. *J Natl Cancer Inst*. 1999;91(18):1541-8. <https://doi.org/10.1093/jnci/91.18.1541>
8. Cuzick J. A breast cancer prediction model incorporating familial and personal risk factors. *Hered Cancer Clin Pract*. 2012;10(Suppl. 2):A29. <https://doi.org/10.1186/1897-4287-10-S2-A29>
9. Antoniou AC, Hardy R, Walker L, Evans DG, Shenton A, Eeles A, et al. Predicting the likelihood of carrying a BRCA 1 or BRCA 2 mutation: validation of BOADICEA, BRCAPRO, IBIS, Myriad and the Manchester scoring system using data from UK genetics clinics. *J Med Genet*. 2008;45(7):425-31. <https://doi.org/10.1136/jmg.2007.056556>
10. Parmigiani G, Chen S, Iversen ES, Friebel TM, Finkelstein DM, Ziogas A, et al. Validity of models for predicting BRCA 1 and BRCA 2 mutations. *Ann Intern Med*. 2007;147(7):441-50. <https://doi.org/10.7326/0003-4819-147-7-200710020-00002>
11. Manahan ER, Kuerer HM, Sebastian M, Hughes KS, Boughey JC, Euhus DM, et al. Consensus Guidelines on Genetic Testing for Hereditary Breast Cancer from the American Society of Breast Surgeons. *Ann Surg Oncol*. 2019;26(10):3025-31. <https://doi.org/10.1245/s10434-019-07549-8>
12. Beitsch PD, Whitworth PW, Hughes K, Patel R, Rosen B, Compagnoni G, et al. Underdiagnosis of Hereditary Breast Cancer: are genetic testing guidelines a tool or na obstacle? *J Clin Oncol*. 2019;37(6):453-60. <https://doi.org/10.1200/jco.18.01631>
13. Thomas E, Mohammed S. Advances in Genetic Testing for Hereditary Cancer Syndromes. In: Pitchert G, Jacobs C (eds.). *Rare Hereditary Cancers*. Cham: Springer; 2016. p. 1-16. [https://doi.org/10.1007/978-3-319-29998-3\\_1](https://doi.org/10.1007/978-3-319-29998-3_1)
14. Palma MD, Domchek SM, Stopfer J, Erlichman J, Siegfried JD, Mason BA, et al. The relative contribution of point mutations and genomic rearrangements in BRCA 1 and BRCA 2 in high-risk breast cancer families. *Cancer Res*. 2008;68(17):7006-14. <https://dx.doi.org/10.1158%2F0008-5472.CAN-08-0599>
15. Walsh T, Casadei S, Lee MK, Pennil CC, Nord AS, Thornton AM, et al. Mutations in 12 genes for inherited ovarian, fallopian tube, and peritoneal carcinoma identified by massively parallel sequencing. *Proc Natl Acad Sci USA*. 2011;108(44):18032-7. <https://doi.org/10.1073/pnas.1115052108>

16. Kurian A, Hughes E, Hanford EA, Gutin A, Allen B, Hartman A-R, et al. Breast and ovarian cancer penetrance estimated derived from germline multiple-gene sequencing results in women. *JCO Precis*. 2017;1:1-12. <https://doi.org/10.1200/PO.16.00066>
17. Walsh T, Casadei S, Coats KH, Swisher E, Stray SM, Higgins J, et al. Spectrum of mutations in BRCA 1, BRCA 2, CHEK 2, and TP53 in families at high risk of breast cancer. *JAMA*. 2006;295(12):1379-88. <https://doi.org/10.1001/jama.295.12.1379>
18. Mavaddat N, Antoniou AC, Easton DF, Garcia-Closas M. Genetic susceptibility to breast cancer. *Mol Oncol*. 2010;4(3):174-91. <https://doi.org/10.1016/j.molonc.2010.04.011>
19. Hall JM, Lee MK, Newman B, Morrow JE, Anderson LA, Huey B, et al. Linkage of early-onset familial breast cancer to chromosome 17q21. *Science*. 1990;250(4988):1684-89. <https://doi.org/10.1126/science.2270482>
20. Kuchenbaecker KB, Hopper JL, Barnes DR, Phillips KA, Mooij TM, Roos-Blom MJ, et al. Risks of breast, ovarian, and contralateral breast cancer for BRCA1 and BRCA2 mutation carriers. *JAMA*. 2017;317(23):2402-16. <https://doi.org/10.1001/jama.2017.7112>
21. Ford D, Easton DF, Stratton M, Narod S, Goldgar D, Devilee P, et al. Genetic heterogeneity and penetrance analysis of the BRCA1 and BRCA2 genes in breast cancer families. The Breast Cancer Linkage Consortium. *Am J Hum Genet*. 1998;62(3):676-89. <https://doi.org/10.1086/301749>
22. van der Groep P, Bouter A, van der Zanden R, Menko FH, Buerger H, Verheijen RH, et al. Re: germline BRCA1 mutations and a basal epithelial phenotype in breast cancer. *J Natl Cancer Inst*. 2004;96(9):712-3; author reply 714. <https://doi.org/10.1093/jnci/djh114>
23. van der Groep P, van der Wall E, van Diest PJ. Pathology of hereditary breast cancer. *Cell Oncol*. 2011;34(2):71-88. <https://dx.doi.org/10.1007%2Fs13402-011-0010-3>
24. Kuhl C, Weigel S, Schrading S, Arand B, Bieling H, König H, et al. Prospective multicenter cohort study to refine management recommendations for women at elevated familial risk of breast cancer: The EVA trial. *J Clin Oncol*. 2010;28(9):1450-7. <https://doi.org/10.1200/jco.2009.23.0839>
25. Riedl CC, Luft N, Bernhart C, Weber M, Bernathova M, Tea MKM, et al. Triple-modality screening trial for familial breast cancer underlines the importance of magnetic resonance imaging and questions the role of mammography and ultrasound regardless of patient mutation status, age, and breast density. *J Clin Oncol*. 2015;33(10):1128-35. <https://doi.org/10.1200/jco.2014.56.8626>
26. Saslow D, Boetes C, Burke W, Harms S, Leach MO, Lehman CD, et al. American Cancer Society guidelines for breast screening with MRI as an adjunct to mammography. *CA Cancer J Clin*. 2007;57(2):75-89. <https://doi.org/10.3322/canclin.57.2.75>
27. Cuzick J, Sestak I, Bonanni B, Constantino JP, Cummings S, DeCensi A, et al. Selective oestrogen receptor modulators in prevention of breast cancer: An updated meta-analysis of individual participant data. *Lancet*. 2013;381(9880):1827-34. [https://doi.org/10.1016/s0140-6736\(13\)60140-3](https://doi.org/10.1016/s0140-6736(13)60140-3)
28. King MC, Wieand S, Hale K, Lee M, Walsh T, Owens K, et al. Tamoxifen and breast cancer incidence among women with inherited mutations in BRCA1 and BRCA2: National Surgical Adjuvant Breast and Bowel Project (NSABP-P1) Breast Cancer Prevention Trial. *JAMA*. 2001;286(18):2251-6. <https://doi.org/10.1001/jama.286.18.2251>
29. Phillips KA, Milne RL, Rookus MA, Daly MB, Antoniou AC, Peock S, et al. Tamoxifen and risk of contralateral breast cancer for BRCA1 and BRCA2 mutation carriers. *J Clin Oncol*. 2013;31(25):3091-99. <https://dx.doi.org/10.1200%2FJCO.2012.47.8313>
30. Ludwig KK, Neuner J, Butler A, Geurts JL, Kong AL. Risk reduction and survival benefit of prophylactic surgery in BRCA mutation carriers, a systematic review. *Am J Surg*. 2016;212(4):660-9. Risk reduction and survival benefit of prophylactic surgery in BRCA mutation carriers, a systematic review. *Am J Surg*.
31. Heemskerk-Gerritsen BAM, Jager A, Koppert LB, Obdeijn AIM, Collée M, Heijboer HEJ, et al. Survival after bilateral risk-reducing mastectomy in healthy BRCA1 and BRCA2 mutation carriers. *Breast Cancer Res Treat*. 2019;177(3):723-33. <https://doi.org/10.1007/s10549-019-05345-2>
32. Boughey JC, Hoskin TL, Degnim AC, Sellers TA, Johnson JL, Kasner MJ, et al. Contralateral prophylactic mastectomy is associated with a survival advantage in high-risk women with a personal history of breast cancer. *Ann Surg Oncol*. 2010;17(10):2702-9. <https://doi.org/10.1245/s10434-010-1136-7>
33. Finch APM, Lubinski J, Møller P, Singer CF, Karlan B, Senter L, et al. Impact of Oophorectomy on Cancer Incidence and Mortality in Women With a BRCA1 or BRCA2 Mutation. *J Clin Oncol*. 2014;32(15):1547-53. <https://dx.doi.org/10.1200%2FJCO.2013.53.2820>
34. Kotsopoulos J, Gronwald J, Karlan BY, Huzarski T, Tung N, Moller P, et al. Hormone replacement therapy after oophorectomy and breast cancer risk among BRCA1 mutation carriers. *JAMA Oncol*. 2018;4(8):1059-65. <https://doi.org/10.1001/jamaoncol.2018.0211>
35. Tung NM, Boughey JC, Pierce LJ, Robson ME, Bedrosian I, Dietz JR, et al. Management of Hereditary Breast Cancer: American Society of Clinical Oncology, American Society for Radiation Oncology, and Society of Surgical Oncology Guideline. *J Clin Oncol*. 2020;38(18):2080-106. <https://doi.org/10.1200/jco.20.00299>
36. Metcalfe K, Gershman S, Ghadirian P, Lynch HT, Snider C, Tung N, et al. Contralateral mastectomy and survival after breast cancer in carriers of BRCA1 and BRCA2 mutations: Retrospective analysis. *BMJ*. 2014;348:g226. <https://doi.org/10.1136/bmj.g226>
37. van den Broek AJ, Schmidt MK, van't Veer LJ, Oldenburg HAS, Rutgers EJ, Russell NS, et al. Prognostic impact of breast-conserving therapy versus mastectomy of BRCA1/2 mutation carriers compared with noncarriers in a consecutive series of young breast cancer patients. *Ann Surg*. 2019;270(2):364-72. <https://doi.org/10.1097/sla.0000000000002804>
38. Park H, Choi DH, Noh JM, Huh SJ, Park W, Nam SJ, et al. Acute skin toxicity in Korean breast cancer patients carrying BRCA mutations. *Int J Radiat Biol*. 2014;90(1):90-4. <https://doi.org/10.3109/09553002.2013.835504>
39. Pierce LJ, Strawderman M, Narod SA, Oliviotto AE, Eisen A, Dawson L, et al. Effect of radiotherapy after breast conserving treatment in women with breast cancer and germline BRCA1/2 mutations. *J Clin Oncol*. 2000;18(19):3360-9. <https://doi.org/10.1200/jco.2000.18.19.3360>

40. Robson M, Im SA, Senkus E, Xu B, Domchek SM, Masuda N, et al. Olaparib for Metastatic Breast Cancer in Patients with a Germline BRCA Mutation. *N Engl J Med*. 2017;377(6):523-33. <https://doi.org/10.1056/nejmoal706450>
41. Litton JK, Rugo HS, Ettl J, Hurvitz SA, Gonçalves A, Lee KH, et al. Talazoparib in Patients with Advanced Breast Cancer and a Germline BRCA Mutation. *N Engl J Med*. 2018;379(8):753-63. <https://doi.org/10.1056/nejmoal802905>
42. Achatz MI, Caleffi M, Guindalini R, Marques RM, Rodrigues AN, Prolla PA. Recommendations for Advancing the Diagnosis and Management of Hereditary Breast and Ovarian Cancer in Brazil. *JCO Glob Oncol*. 2020;6:439-52. <https://doi.org/10.1200/jgo.19.00170>
43. Chompret A, Brugieres L, Ronsin M, Gardes M, Freichey FD, Abel A, et al. P53 germline mutations in childhood cancers and cancer risk for carrier individuals. *Br J Cancer*. 2000;82(12):1932-37. <https://dx.doi.org/10.1054%2Fbjoc.2000.1167>
44. Petitjean A, Mathe E, Kato S, Ishioka C, Tavtigian SV, Hainaut P, et al. Impact of mutant p53 functional properties on TP53 mutation patterns and tumor phenotype: lessons from recent developments in the IARC TP53 database. *Hum Mutat*. 2007;28(6):622-9. <https://doi.org/10.1002/humu.20495>
45. Olivier M, Goldgar DE, Sodha N, Ohgaki H, Kleihues P, Hainaut P, et al. Li-Fraumeni and related syndromes: correlation between tumor type, family structure, and TP53 genotype. *Cancer Res*. 2003;63(20):6643-50.
46. Achatz MIW, Olivier M, Le Calvez F, Martel-Planche G, Lopes A, Rossi BM, et al. The TP53 mutation, R337H, is associated with Li-Fraumeni and Li-Fraumeni-like syndromes in Brazilian families. *Cancer Lett*. 2007;245(1-2):96-102. <https://doi.org/10.1016/j.canlet.2005.12.039>
47. Limacher JM, Frebourg T, Natarajan-Ame S, Bergerat JP. Two metachronous tumors in the radiotherapy fields of a patient with Li-Fraumeni syndrome. *Int J Cancer*. 2001;96(4):238-42. <https://doi.org/10.1002/ijc.1021>
48. Henry E, Villalobos V, Million L, Jensen KC, West R, Ganjoo K, et al. Chest wall leiomyosarcoma after breast-conservative therapy for early-stage breast cancer in a young woman with Li-Fraumeni syndrome. *J Natl Compr Canc Netw*. 2012;10(8):939-42. <https://doi.org/10.6004/jnccn.2012.0097>
49. Kratz CP, Achatz MI, Brugières L, Frebourg T, Garber JE, Greer MLC, et al. Cancer Screening Recommendations for Individuals with Li-Fraumeni Syndrome. *Clin Cancer Res*. 2017;23(11):e38-e45. <https://doi.org/10.1158/1078-0432.ccr-17-0408>
50. Tan MH, Mester J, Peterson C, Yang Y, Chen JL, Rybicki LA, et al. A Clinical Scoring System for Selection of Patients for PTEN Mutation Testing Is Proposed on the Basis of a Prospective Study of 3042 Proband. *Am J Hum Genet*. 2011;88(1):42-56. <https://dx.doi.org/10.1016%2Fj.ajhg.2010.11.013>
51. Zbuk KM, Eng C. Cancer phenomics: RET and PTEN as illustrative models. *Nat Rev Cancer*. 2007;7(1):35-45. <https://doi.org/10.1038/nrc2037>
52. Takeichi M. Cadherin cell adhesion receptors as a morphogenetic regulator. *Science*. 1991;251(5000):1451-5. <https://doi.org/10.1126/science.2006419>
53. Pharoah PD, Guilford P, Caldas C. Incidence of gastric cancer and breast cancer in CDH1 (E-cadherin) mutation carriers from hereditary diffuse gastric cancer families. *Gastroenterology*. 2001;121(6):1348-53. <https://doi.org/10.1053/gast.2001.29611>
54. Figueiredo J, Melo S, Carneiro P, Moreira AM, Fernandes MS, Ribeiro AS, et al. Clinical spectrum and pleiotropic nature of CDH1 germline mutations. *J Med Genet*. 2019;56(4):199-208. <https://doi.org/10.1136/jmedgenet-2018-105807>
55. National Comprehensive Cancer Network. Genetic/Familial High-Risk Assessment: Breast and Ovarian [Internet]. National Comprehensive Cancer Network; 2020 [accessed on May 27, 2020]. Available at: [https://www.nccn.org/store/login/login.aspx?ReturnURL=https://www.nccn.org/professionals/physician\\_gls/pdf/genetics\\_bop.pdf](https://www.nccn.org/store/login/login.aspx?ReturnURL=https://www.nccn.org/professionals/physician_gls/pdf/genetics_bop.pdf)
56. Cisco RM, Ford JM, Norton JA. Hereditary diffuse gastric cancer: implications of genetic testing for screening and prophylactic surgery. *Cancer*. 2008;113(7 Suppl.):1850-6. Hereditary diffuse gastric cancer: implications of genetic testing for screening and prophylactic surgery. *Cancer*.
57. Hearle N, Schumacher V, Menko FH, Olschwang S, Boardman LA, Gille JJP, et al. Frequency and spectrum of cancers in the Peutz-Jeghers syndrome. *Clin Cancer Res*. 2006;12(10):3209-15. <https://doi.org/10.1158/1078-0432.ccr-06-0083>
58. Giardiello FM, Trimbath JD. Peutz-Jeghers syndrome and management recommendations. *Clin Gastroenterol Hepatol*. 2006;4(4):408-15. <https://doi.org/10.1016/j.cgh.2005.11.005>
59. Syngal S, Brand RE, Church JM, Giardiello FM, Hampel HL, Burt RW, et al. ACG clinical guideline: Genetic testing and management of hereditary gastrointestinal cancer syndromes. *Am J Gastroenterol*. 2015;110(2):223-62. <https://dx.doi.org/10.1038%2Fajg.2014.435>
60. Shiovitz S, Korde LA. Genetics of breast cancer: a topic in evolution. *Ann Oncol*. 2015;26(7):1291-9. <https://dx.doi.org/10.1093%2Fannonc%2Fmdv022>
61. Wendt C, Margolin S. Identifying breast cancer susceptibility genes – a review of the genetic background in familial breast cancer. *Acta Oncol*. 2019;58(2):135-46. <https://doi.org/10.1080/0284186x.2018.1529428>
62. Antoniou AC, Foulkes WD, Tischkowitz M. Breast-cancer risk in families with mutations in PALB2. *N Engl J Med*. 2014;371(17):1651-2. <https://doi.org/10.1056/nejmc1410673>
63. Easton DF, Pharoah PDP, Antoniou AC, Tischkowitz M, Tavtigian SV, Nathanson KL, et al. Gene-panel sequencing and the prediction of breast-cancer risk. *N Engl J Med*. 2015;372:2243-57. <https://doi.org/10.1056/NEJMsr1501341>
64. Yurgelun MB, Hiller E, Garber JE. Population-wide screening for germline BRCA1 and BRCA2 mutations: Too much of a good thing? *J Clin Oncol*. 2015;33(28):3092-5. <https://doi.org/10.1200/jco.2015.60.8596>



# Family history of breast cancer and risk of benign breast diseases: an integrative literature review

Marla Presa Raulino Schilling<sup>1\*</sup> , Ilce Ferreira da Silva<sup>1</sup> 

## ABSTRACT

**Introduction:** Some benign breast diseases (BBD) can determine an increased risk of developing breast cancer. Environmental factors related to lifestyle and family history of breast cancer may be associated with BBD development. However, the effect of family history of breast cancer on the risk of benign breast diseases is still unclear. **Objective:** To evaluate the association between family history of breast cancer and benign breast diseases. **Methods:** This is an integrative review that selected observational studies in different databases to analyze the association between BBD and family history of breast cancer, considering the different classification criteria for both benign diseases and family history. All studies were published between 1977 and 2016. A total of 13 studies were selected, among which ten are case-control and case-cohort studies; and three are cohort studies. Most studies received high or moderate quality classification according to the Newcastle-Ottawa assessment scale. **Results:** Family history of breast cancer was associated with the development of proliferative lesions and the presence of atypia, and it was more closely related to the development of benign diseases in young women, with a tendency to decrease with advancing age. **Conclusion:** Studies suggest there may be an association between family history of breast cancer and benign breast diseases; nevertheless, no statistically significant results were found in many case-control studies, and more robust prospective research is necessary to further clarify this association.

**KEYWORDS:** breast diseases; fibrocystic breast disease; breast neoplasms.

## INTRODUCTION

Benign Breast Diseases (BBD) represent a public health issue insofar as they are classified as one of the main risk factors for breast cancer<sup>1</sup> and correspond to one to two million diagnoses of breast biopsies in the United States of America per year<sup>2,3</sup>. BBD encompass a wide range of histological changes<sup>4,5</sup>, which attribute variable risk of breast cancer to women<sup>6</sup> and can be classified as nonproliferative, proliferative without atypia, and proliferative with atypia (atypical hyperplasia)<sup>7</sup>.

Studies have shown an increase in the risk of breast cancer of 1.45 to 1.9 times higher in women with proliferative lesions without atypia compared with women with nonproliferative lesions, and 3.75 to 5.3 times higher in women with atypical hyperplasia<sup>7-10</sup>. In addition to increasing the risk of breast cancer, certain benign diseases have been associated with the development of both multifocal tumors<sup>11</sup>, which are lesions that have a worse prognosis, and of hormone receptor-positive breast cancer, the most incident in the female population<sup>12,13</sup>.

Although the process of mammary carcinogenesis is not fully understood, studies support the development of breast cancer in which atypia represents a nonobligate precursor of low-grade ductal carcinoma *in situ* and of invasive carcinoma<sup>14,15</sup>. Still in the 1970s, Wellings et al.<sup>16</sup> described the evolution of some benign diseases, in which hyperplastic epithelial cells of the breast would slowly increase the terminal duct lobular units, progressing to atypical ductal hyperplasia, ductal carcinoma *in situ*, and invasive carcinoma, successively.

Therefore, epidemiological studies on the etiology of benign breast diseases have, in general, evaluated the same risk factors established for breast cancer. Similar to what has been observed regarding invasive lesions, studies show that environmental and lifestyle-related factors, such as diet, alcohol consumption, physical inactivity, and the use of hormone replacement therapy, may be linked to the development of benign lesions<sup>17-21</sup>.

Considering that family history of breast cancer is one of the most significant risk factors for the development of

<sup>1</sup>Graduate Program in Public Health and Environment, Escola Nacional de Saúde Pública, Fundação Oswaldo Cruz – Rio de Janeiro (RJ), Brazil.

\*Corresponding author: marla\_presa\_raulino@hotmail.com

Conflict of interests: nothing to declare.

Received on: 06/16/2020. Accepted on: 07/29/2020.

invasive carcinoma<sup>1</sup>, it has also been investigated in the etiology of benign lesions<sup>21-23</sup>. Family history of breast cancer comprises both the effect of the genetic load<sup>24</sup> and environmental exposures<sup>1</sup>. In addition to genetic inheritance, people from the same family nucleus tend to share the same exposures<sup>25</sup>, including eating and living habits, exposures to carcinogens at home, such as endocrine disruptors present in household cleaning products<sup>26,27</sup>, access to diagnostic and screening services, knowledge of the disease, among others<sup>28</sup>. In this sense, knowledge of the etiology of benign breast diseases and the identification of women at greater risk of developing them could have important implications for preventing breast cancer in high-risk groups through screening and, when indicated, chemoprevention and prophylactic surgery<sup>29</sup>.

Although there are literature reviews about the epidemiological factors associated with the development of benign lesions, including family history of cancer, none of them considered the different classification criteria used for family history, and neither the various histological types. The reviews found so far were carried out more than ten years ago and identified risk factors for specific lesions, such as fibrocystic lesions, fibroadenomas, and some lesions with degrees of atypia<sup>30</sup>, as well as benign proliferative epithelial disorders<sup>31</sup>.

Therefore, the present review aimed to evaluate the effect of family history of breast cancer on the risk of developing benign breast diseases, considering all histological types of BBD and the different criteria for classifying family history.

## METHODS

### Study design

This is an integrative literature review that sought to answer the following question: do women with family history of breast cancer have a higher risk of developing benign breast diseases than those without family history of breast cancer?

The study was registered on the International Prospective Register of Systematic Reviews (PROSPERO) database (CRD42020156687).

### Selection criteria

A search was carried out for observational studies of the types cohort, case-control, and cross-sectional, which assessed the role of family history of breast cancer in women of any age group diagnosed with benign breast diseases. The population of the selected studies consisted of women with diagnostic confirmation of BBD by breast biopsy or breast cytology. Studies published in English, Spanish, and Portuguese languages were eligible for this study. For the selection of articles, there was no restriction on the date of publication of the study. The assessed outcome was any type of BBD. The exposure of interest consisted of family

history of breast cancer. For studies that did not present risk estimates, but reported the values necessary to calculate them, the authors of the present review carried out the analyses and reported the estimated risk. The risk estimates extracted from studies included the relative risk, the odds ratio, the hazard ratio, and the prevalence odds ratio.

### Research strategy and information sources

An electronic search was conducted in the following databases: PubMed (Medical Literature Analysis and Retrieval System – MEDLINE), Scopus, Google Scholar, and Virtual Health Library (VHL). In addition, aiming at finding all sources for the review, studies in gray literature and in the references of the selected articles were searched. For articles selected in the PubMed database, the terms *benign breast disease OR nonproliferative breast disease OR proliferative breast disease OR proliferative breast disease without atypia OR proliferative breast disease with atypia OR benign proliferative epithelial disorders AND family history* and its variants were used.

In the first search, 514 articles were identified. After evaluating the titles and abstracts, 26 articles were selected as potentially eligible. In the Scopus database, the search for titles, abstracts, or descriptors using the same terms and search engine resulted in 290 documents. After reviewing the documents, 16 articles were identified with potential for inclusion (Figure 1).

Regarding Google Scholar, the search with the same terms used in PubMed and Scopus generated 12,100 results. Considering the *benign breast disease and family history of breast cancer* terms, 6,080 articles were found. Thus, the search was limited to the title of the articles, and the result showed 23 publications, all selected as potentially eligible. The search for the terms *benign proliferative breast disease and family history of breast cancer*, using the limit option “exact expression anywhere in the article,” found 272 results, of which 21 were selected. Regarding the term *benign proliferative epithelial disorders and family history of breast cancer*, 107 results were found, 11 of which were potentially eligible. Finally, 55 potentially eligible articles on Google Scholar were identified.

In the VHL regional portal, the following terms were used for advanced search limited by title, abstract, or subject: *benign breast disease and family history of breast cancer*; *benign proliferative breast disease and family history of breast cancer*; *benign proliferative epithelial disorders and family history of breast cancer*, which resulted in 653, 46, and three publications, respectively. Of this total, 18 were selected as potentially eligible.

### Study selection and data extraction

The process of identification and selection of articles followed the recommendations described in the PRISMA (Preferred Reporting Items for Systematic Reviews and Meta-Analyses) flow diagram<sup>32</sup>. First, articles were selected based on their title/abstract, and duplicate articles were excluded.

The second step of the evaluation was based on the content of the articles, which were selected according to the inclusion criteria. For overlapping studies, only the one with the largest number of individuals in the sample was selected. One of the authors of the present study performed the data extraction, and the second author reviewed the gathered information with the aid of a spreadsheet for data extraction. In cases in which there were doubts about the extracted information, the authors made a joint assessment until reaching a consensus.

The authors extracted information on the date of publication of the study, research design, study population (criteria for defining cases and controls), frequency of family history of cancer in the study population (for case-control studies), cumulative risk (for cohort studies), and risk estimates, according to the criteria used in each study (BBD histological characteristic, age, menopausal status, and family history of breast cancer).

The Newcastle-Ottawa scale<sup>33</sup> was used to assess the methodological quality of the included studies. This scale is composed of three categories (selection, comparability, and outcome) and scores up to nine points (stars). It can be applied to cohort and case-control studies and classifies them as high quality (7 to 9 stars), moderate quality (5 to 6 stars), or low quality (0 to 4 stars).

The studies were grouped according to the methodological design into two categories:

- case-control, nested case-control, and case-cohort studies (Chart 1);
- cohort studies (Chart 2).

No cross-sectional study was found within the search period.

## RESULTS

### Identification of studies

A total of 47 studies were identified in the electronic databases. 14 articles were excluded after the initial screening based on title/abstract. After content evaluation, 13 articles that met the selection criteria were included. Figure 1 summarizes the selection of the included studies.

### Study characteristics

Among the 13 included studies, seven were carried out on North American populations; one of Central America; two of South America; one of Oceania; and two of Asia, corresponding to three cohort studies, eight case-control studies, one nested case-control study, and one case-cohort study. The studies were published between 1977 and 2016 and used different criteria for classifying family history of breast cancer. In total, four studies evaluated the family history of breast cancer in first-degree relatives<sup>22,23,34,35</sup> and four others in relatives with any degree of consanguinity<sup>18,36-38</sup>. Hardy et al.<sup>39</sup> and Berkey et al.<sup>21</sup> evaluated

the history of the mother, sister, aunt, cousin, and grandmother. The other studies analyzed the family history of breast cancer in the mother and/or sister<sup>40-42</sup>. A summary of the characteristics of each study is presented in Charts 1 and 2.

### Assessment of the quality of studies

According to the classification of the Newcastle-Ottawa scale, among the three cohort studies included, Hislop and Elwood<sup>41</sup> and Webb et al.<sup>22</sup> received 6 stars, and were considered studies of moderate quality. The study conducted by Berkey et al.<sup>21</sup> received 4 stars and was considered a study of low methodological quality. The studies were carried out on specific populations, thus not representing the general population. In the cohort study conducted by Berkey et al.<sup>21</sup>, the outcome was assessed using a self-administered questionnaire, and it was not possible to guarantee that the outcome was not present at the beginning of the study. Among the case-control, nested case-control, and case-cohort studies, the observed methodological quality was moderate and high ( $\geq 6$  stars). A total of 60% of the studies did not report whether nonresponse frequency was the same for cases and controls<sup>35-39,42</sup>. Information on the quality assessment of each study can be found in Chart 3.

Only two studies aimed to specifically assess the association between BBD and family history of breast cancer<sup>21,22</sup>, and three other studies evaluated several risk factors, including family history of the disease<sup>36,40-42</sup>. The other studies focused on reproductive factors and/or diet<sup>18,23,34,37,39</sup>; composition of fatty acids and breast adipose tissue<sup>38</sup>; and on serum levels of insulin, estradiol, C-reactive protein, and adiponectin<sup>35</sup>.

### Case-control and case-cohort studies

Among the case-control studies that evaluated the family history of breast cancer in any relative (general), two observed positive associations, with a magnitude of association ranging between 1.1 and 2 ( $p > 0.05$ ); however, the results were not statistically significant<sup>18,36</sup>. Conversely, two other studies found a statistically significant difference between the group of women with BBD and the control group concerning the presence of a family history of breast cancer in any relative ( $p < 0.01$ )<sup>37,38</sup>.

Among the studies that evaluated the association between family history of breast cancer in first-degree relatives and BBD<sup>23,34,35</sup>, there was a positive association ranging from 1.17 (95% confidence interval – 95%CI 0.92–1.48) to 1.97 (95%CI 0.93–4.16), although without statistical significance. Furthermore, Wu et al.<sup>23</sup> observed that the association was strongly positive among women diagnosed with nonproliferative lesions (odds ratio – OR<sub>adjusted for age</sub> = 3.8; 95%CI 0.9–16.8); proliferative lesion (OR<sub>adjusted for age</sub> = 2.8; 95%CI 0.6–13.6); and atypical lesion (OR<sub>adjusted for age</sub> = 3.2; 95%CI 0.04–63.2), but the results were not statistically significant. Minami et al.<sup>42</sup> also evaluated the association according to the presence of histological proliferation, following the criteria of Dupont and Page<sup>7</sup>, and found a

**Chart 1.** Characteristics of case-control, case-cohort, and nested case-control studies regarding family history of breast cancer and risk of BBD.

Authors, year	Location	Population	Family history of BC (definition)	Frequency of family history (%)	OR (95%CI)
Galván-Portillo et al., 2002 <sup>18</sup>	Mexico City, Mexico	Cases: 121 women with BBD. Controls: 121 (clinical).	Family history (general)	Cases: 8 (6.7) Controls: 5 (4.13)	FH- =1 FH+ =2 (0.60; 6.64) <sup>+</sup>
Wu et al., 2004 <sup>23</sup>	Shanghai, China	Cases: with atypia (33); proliferative without atypia (181 cases); nonproliferative (175 cases). Controls: 1,070 women with normal self-examination.	Family history in first-degree relatives	Nonproliferative lesions Cases: 6 (3.4) Controls: 17 (1.59) Proliferative lesions Cases: 5 (2.7) Controls: 17 (1.59) Lesions with atypia Cases: 1 (3) Controls: 17 (1.59)	Nonproliferative lesions FH- =1 FH+ =3.8 (0.9; 16.8) <sup>+</sup> Proliferative lesions FH- =1 FH+ =2.8 (0.6; 13.6) <sup>+</sup> Lesions with atypia FH- =1 FH+ =3.2 (0.04; 63.2) <sup>+</sup> All lesions FH- =1 FH+ =1.97 (0.93; 4.16) <sup>+</sup>
Ingram et al., 1991 <sup>34</sup>	Perth, Australia	Cases: 91 women with benign epithelial hyperplasia and 95 women with benign fibrocystic breast disease. Controls: 209 women identified through electoral registers.	Family history in first-degree relatives	Benign epithelial hyperplasia Cases: 9 (10) Controls: 12 (6) Fibrocystic disease Cases: 7 (7.3) Controls: 12 (6)	Both FH- =1 FH+ =1.45 (0.67; 3.15) <sup>*a</sup> Benign epithelial hyperplasia FH- =1 FH+ =1.80 (0.73; 4.43) <sup>*a</sup> Fibrocystic disease FH- =1 FH+ =1.30 (0.49; 3.41) <sup>*a</sup>
Catsburg et al., 2014 <sup>35</sup>	United States of America	Cases: 667 women with benign proliferative disease. Controls: 1,321 women without abnormal mammography or abnormal clinical examination.	Family history in first-degree relatives	Cases: 136 (20.4) Controls: 237 (17.9)	FH- =1 FH+ =1.17 (0.92; 1.48) <sup>*b</sup>
Bright et al., 1989 <sup>36</sup>	Boston, United States of America	Cases: 172 women with mammography and BBD biopsy. Controls: 134 women with normal routine mammography.	Family history of breast cancer (general)	-	Both FH- =1 FH+ =1.1 (0.65; 2.0) <sup>+</sup> Premenopausal status FH- =1 FH+ =1.1 (0.54; 2.4) <sup>+</sup> Postmenopausal status FH- =1 FH+ =1.2 (0.48; 2.8) <sup>+</sup>
Rohan et al., 1998 <sup>37</sup> Case-cohort	Canada	Cases: 545 women with proliferative epithelial lesions. Non-cases: 4,921 selected from a stratified random sample (by selection center).	Family history (general)	Cases: 99 (18.2) Non-cases: 546 (11.1)	FH- =1 FH+ =1.78 (1.40; 2.25) <sup>*c</sup>
Conceição et al., 2016 <sup>38</sup>	Belo Horizonte, Brazil	Cases: 75 with BBD. Controls: 116 women who underwent a routine exam or gynecological surgery and had a recent mammogram result.	Family history (general)	Cases: 13 (17.33) Controls: 0	There was a statistically significant difference between the group of women with BBD and the control group in relation to the presence of FH of BC (p<0.001).

Continue...

Chart 1. Continuation.

Authors, year	Location	Population	Family history of BC (definition)	Frequency of family history (%)	OR (95%CI)
Hardy et al., 1990 <sup>39</sup>	Campinas, Brazil	Cases: 257 women with BBD biopsy or cytology Controls: 257 women diagnosed with healthy breasts.	Family history of breast cancer in mother, sister, daughter, aunt, cousin, and grandmother.	Mother Cases: 10 (3.9) Controls: 5 (1.9) Sister Cases: 4 (1.6) Controls: 3 (1.2) Daughter Cases: 0 Controls: 0 Aunt Cases: 15 (5.8) Controls: 12 (4.7) Cousin Cases: 8 (3.1) Controls: 7 (2.7) Grandmother Cases: 6 (2.3) Controls: 3 (1.2)	Mother FH- =1 FH+ =2.04 (0.69; 6.05)* <sup>d</sup> Sister FH- =1 FH+ =1.34 (0.29; 6.05)* <sup>d</sup> Aunt FH- =1 FH+ =1.26 (0.58; 2.75)* <sup>d</sup> Cousin FH- =1 FH+ =1.15 (0.41; 3.22)* <sup>d</sup> Grandmother FH- =1 FH+ =2.02 (0.50; 8.16)* <sup>d</sup>
Nomura et al., 1977 <sup>40#</sup>	Washington County, United States of America	Cases: 320 women with cystic disease and fibroadenoma. Controls: 320 women selected through a population census.	Family history of maternal cancer	Cystic disease and fibroadenoma Cases: 14 (4.4) Controls: 7 (2.2) Cystic disease Cases: 12 (4.4) Controls: 6 (2.2) Fibroadenoma Cases: 2 (4.4) Control: 1 (2.2)	Cystic disease and fibroadenoma FH- =1 FH+ =2.04 (0.81; 5.12)* <sup>e</sup> Cystic disease FH- =1 FH+ =2.04 (0.75; 5.51)* <sup>e</sup> Fibroadenoma FH- =1 FH+ =2.04 (0.18; 23.33)* <sup>e</sup>
Minami et al., 1998 <sup>42</sup>	Miyagi, Japan	Cases: 382 women with BBD biopsy. Controls: 1,498 women who participated in screening programs, in which the cases were identified, and who did not present changes in the exams.	Family history of mother or sister with breast cancer	Proliferative lesions Cases: 8 (6.1) Controls: 8 (1.6) Nonproliferative lesions Cases: 12 (4.8) Controls: 26 (2.6)	Proliferative lesions FH- =1 FH+ =4.31 (1.55; 11.95) <sup>§</sup> Nonproliferative lesions FH- =1 FH+ =1.80 (0.90; 3.59) <sup>§</sup>

#Cystic disease included fibrocystic disease, chronic cystic mastitis, sclerosis, adenosis, and papillomatosis; <sup>§</sup>OR adjusted for age at menarche and parity; \*OR adjusted for age; <sup>e</sup>estimates calculated by the authors of the present review, based on the family history of cases and controls made available in the studies; <sup>a</sup>the study paired cases and controls by age and place of residence; <sup>b</sup>the study paired cases and controls by age, race, blood collection date, and randomization group; <sup>c</sup>a crude estimate was calculated. It was not adjusted by confounding variables; <sup>d</sup>the study paired cases and controls by age, year of diagnosis, and place of consultation; <sup>e</sup>the study paired cases and controls by age; BBD: benign breast diseases; BC: breast cancer; FH: family history; OR: odds ratio; 95%CI: 95% confidence interval.

positive and statistically significant association between family history of breast cancer in the mother or sister and proliferative lesions (OR<sub>crude</sub> = 4.31; 95%CI 1.55–11.95) (Chart 1).

Studies that assessed the association between family history of breast cancer and BBD (Chart 1) according to menopausal status did not find a statistically significant association for family history of breast cancer in general relatives (OR<sub>premenopausal</sub> = 1.1; 95%CI 0.54–2.4; OR<sub>postmenopausal</sub> = OR = 1.2; 95%CI 0.48–2.8)<sup>36</sup>, and neither for family history of breast cancer in first-degree relatives (OR<sub>postmenopausal</sub> = 1.17; 95%CI 0.92–1.48)<sup>35</sup>.

On the other hand, the two case-control studies that evaluated the maternal family history of breast cancer<sup>39,40</sup> verified that the maternal history of the disease was strongly associated with the development of benign lesions (OR = 2.04; p>0.05), although

the results were not statistically significant. In addition, it was observed that women with a maternal history of breast cancer were 2.04 times more likely to develop cystic disease (95%CI 0.75–5.51) and fibroadenoma (95%CI 0.18–23.33)<sup>40</sup> (Chart 1).

Ingram et al.<sup>34</sup> also assessed the association by specific type of lesion and observed that women with a family history of breast cancer in first-degree relatives were 1.3 times more likely to have fibrocystic disease (95%CI 0.49–3.41) and 1.8 times more likely to have benign epithelial hyperplasia (OR = 1.8; 95%CI 0.73–4.43); nevertheless, the results were not statistically significant.

Figure 2 shows the frequency of family history of breast cancer in the cases and controls of the included studies, according to the different family history classification criteria. Approximately twice as many women with a family history of maternal breast cancer were



verified among cases compared with controls. A total of 11.33% of women had a family history of breast cancer in first-degree relatives between cases, against 7.32% in the control groups, and 16.19% of women had a family history of breast cancer regardless of the relatives' degree in the case groups, against 10.68% in the controls.

### Cohort studies

In cohort studies, a positive and statistically significant association was observed between BBD and family history of breast cancer as for: age (25–29 years: relative risk – RR = 2.08; 95%CI 1.09–3.96)<sup>22</sup>; age and sister with breast cancer (30–50 years: RR = 2.9; p≤0.01; >50 years: RR = 2.65, p≤0.01)<sup>41</sup>; first-degree relatives with breast cancer (RR = 1.67; 95%CI 1.47–1.90)<sup>22</sup>; aunt with breast cancer (OR = 2.71; 95%CI 1.16–6.34); mother, aunt, or maternal grandmother with breast cancer (OR = 1.92; 95%CI 1.12–3.27)<sup>21</sup>; two or more affected family members (OR = 4.26, p=0.02)<sup>21</sup>; and atypia compared with proliferative disease without atypia (prevalence odds ratio – POR<sub>adjusted for age</sub> = 2.76; 95%CI 1.33–5.74) or any BBD without atypia (POR<sub>adjusted for age</sub> = 2.16; 95%CI 1.05–4.35)<sup>22</sup>(Chart 2).

## DISCUSSION

The results of the present review suggest a positive association between family history of breast cancer and BBD. Family history of breast cancer was strongly associated with the development of BBD in case-control studies that classified lesions according to histological and/or atypical proliferation<sup>23,42</sup>. Women diagnosed with proliferative lesions were 4.3 times more likely to have a family history of breast cancer in the mother or sister (95%CI 1.55–11.95) than those without a family history<sup>42</sup>. Despite the strong association observed between family history in first-degree relatives and nonproliferative lesion, proliferative lesion, and lesion with atypia, none of the estimates were statistically significant and had a wide confidence interval, probably due to the low frequency of family history of breast cancer in the study population<sup>23</sup>, verified in the low breast cancer incidence rates historically observed in the population of Shanghai<sup>43</sup>.

The study conducted by Webb et al.<sup>22</sup> showed that atypia was significantly associated with a family history of breast cancer in first-degree relatives compared with proliferative lesion without

**Chart 2.** Characteristics of cohort studies regarding family history of breast cancer and risk of BBD.

Authors, year	Location	Population	Family history of BC (definition)	Cumulative risk (%)	HR/RR/OR/POR	
Berkey et al., 2012 <sup>21</sup>	United States of America	6,888 young girls (9 to 15 years old), 67 with biopsy of benign disease.	Family history of mother, aunt, maternal grandmother, one family member, and two family members.	–	<b>OR for mother</b> FH- =1 FH+ =2.07 (0.83–5.20) <b>OR for aunt</b> FH- =1 FH+ =2.71 (1.16–6.34) <b>OR for mother, aunt or grandmother</b> FH- =1 FH+ =1.92 (1.12–3.27)	<b>OR for one family member</b> FH- =1 FH+ =1.74 (p=0.058) <b>OR for two or more family members</b> FH- =1 FH+ =4.26 (p=0.02)
Webb et al., 2002 <sup>22</sup>	United States of America	80,995 women in the baseline; 16,849 self-reported a medical diagnosis of BBD; 3,165 had their diagnosis confirmed by biopsy.	Family history in first-degree relatives	–	<b>BBD confirmed by biopsy</b> FH- =1 FH+ =1.67 (1.47–1.90) <b>POR for atypia in the general BBD (with or without proliferation)</b> FH- =1 FH+ =2.16 (1.05–4.35) <b>POR for atypia in proliferative BBD</b> FH- =1 FH+ =2.76 (1.33–5.74)	<b>25–29 years</b> FH- =1 FH+ =2.08 (1.09–3.96) <b>45–50 years</b> FH- =1 FH+ =1.31 (0.83–2.06)
Hislop and Elwood, 1981 <sup>41</sup>	Vancouver, Canada	1,374 women in the baseline, 726 of whom completed the follow-up questionnaires and 107 had biopsy confirming the diagnosis of benign breast disease.	Family history in mother and sister	Mother <30 years: 0 30–50 years: 11 >50 years: 11 Sister <30 years: 14 30–50 years: 36 >50 years: 45	<b>&lt;30 years</b> FH- sister =1 FH+ sister =3.1 (p>0.05) <b>30–50 years</b> FH- mother =1 FH+ mother =0.8 (p>0.05) FH- sister =1 FH+ sister =2.9 (p=0.005)	<b>&gt;50 years</b> FH- mother =1 FH+ mother =0.65 (p>0.05) FH- sister =1 FH+ sister =2.65 (p=0.001)

BBD: benign breast diseases; BC: breast cancer; FH: family history; HR: hazard ratio; RR: relative risk; OR: odds ratio; POR: prevalence odds ratio.

atypia or any BBD without atypia (with or without proliferation). The study was conducted in a large cohort of 80,995 women, 3,165 of whom had diagnostic confirmation of BBD. When assessing the association according to women's age, the authors observed that, in the age group of 25–29 years, the risk of BBD was twice as high (95%CI 1.09–3.96); and in the age group of 45–50 years, the risk was 1.3 times higher (95%CI 0.83–2.06) for those with a family

history of breast cancer in first-degree relatives. In Canada, the family history of breast cancer in the sister was positively associated with BBD and varied by age group: 3.1 ( $p > 0.05$ ), in women aged <30 years; 2.9 ( $p < 0.01$ ), in women aged 30 to 50 years; and 2.65 ( $p < 0.01$ ), among those aged >50 years<sup>41</sup>.

These results suggest that family history of breast cancer is associated with proliferative breast lesions and the presence of

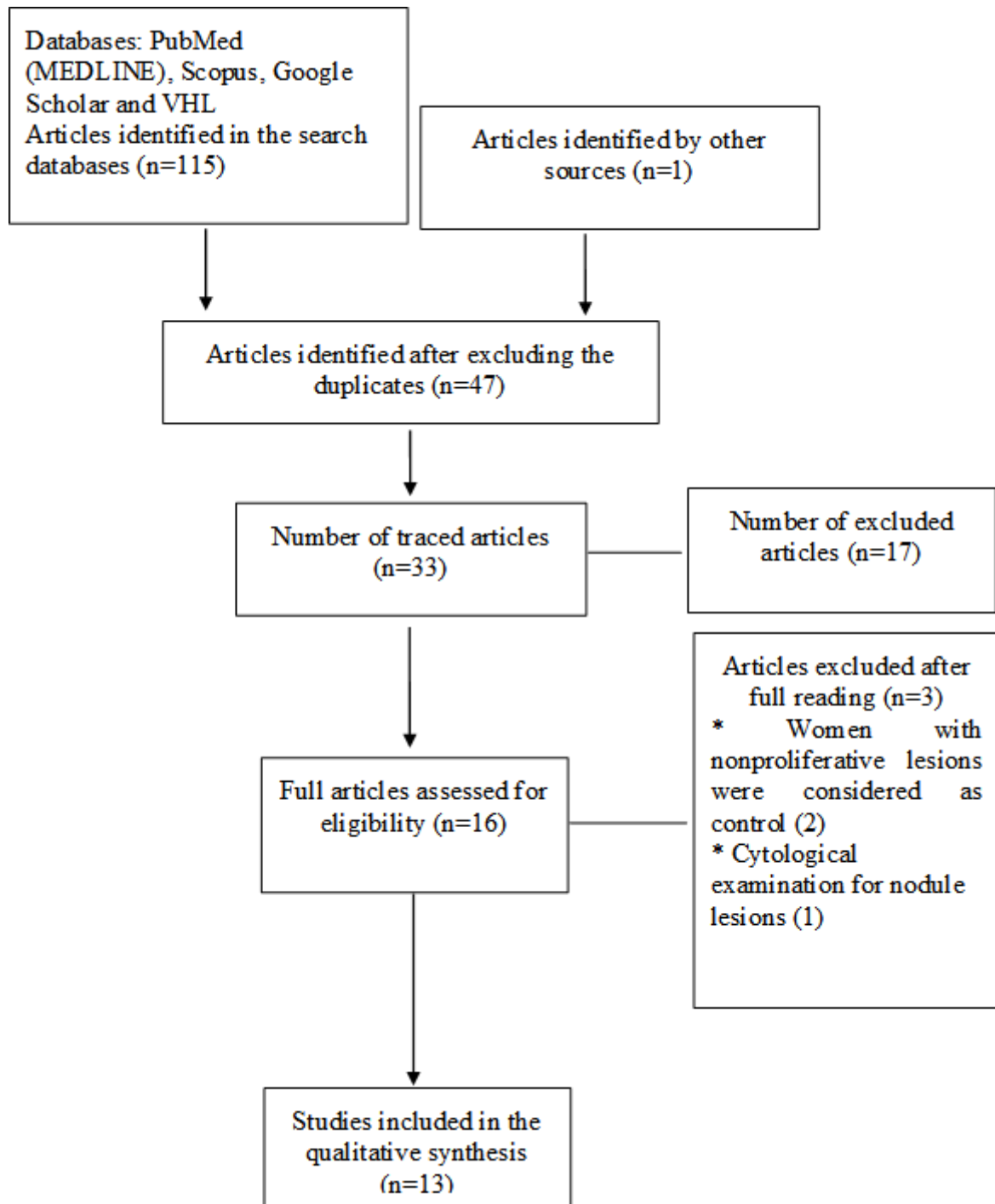

MEDLINE: Medical Literature Analysis and Retrieval System; VHL: Virtual Health Library.

**Figure 1.** Flow diagram of the selection of articles.

atypia, which are lesions that increase the risk of breast cancer<sup>6</sup>. However, such association is stronger in young women and tends to decrease with advancing age. First-degree relatives, especially sisters, of young women tend to be relatively young, and the breast cancer diagnosis at this stage of life is more likely to be related to genetic factors than to environmental factors<sup>22,44,45</sup>.

The results may depict the tendency of women with a family history of breast cancer to seek medical care more frequently than those without a family history<sup>46</sup>, if they suspect any change in the breasts. Moreover, breast biopsy has been strongly recommended by doctors for women with a family history of breast

cancer, which could represent a selective surveillance bias<sup>47</sup>. However, the cohort and case-control studies on women who were routinely screened as the study population were deemed more appropriate, considering that such studies allowed to overcome this surveillance bias<sup>48,49</sup>. This rationale is supported by the fact that women with and without family history would have equal opportunities for diagnosis in these research designs. Thus, the estimates presented by such research may represent an association closer to the reality in the source population.

The scores obtained using the Newcastle-Ottawa scale reinforce the methodological quality of the research included

**Chart 3.** Classification of the methodological quality of the selected studies according to the Newcastle-Ottawa scale.

Reference	Study design	Selection	Comparability	Outcome	Total
Galván-Portillo et al., 2002 <sup>18</sup>	Case-control	3	1	2	6
Berkey et al., 2012 <sup>21</sup>	Cohort	1	1	2	4
Webb et al., 2002 <sup>22</sup>	Cohort	2	1	3	6
Wu et al., 2004 <sup>23</sup>	Case-control	4	1	2	7
Ingram et al., 1991 <sup>34</sup>	Case-control	4	2	3	9
Catsburg et al., 2014 <sup>35</sup>	Nested case-control	3	2	2	7
Bright et al., 1989 <sup>36</sup>	Case-control	3	1	2	6
Rohan et al., 1998 <sup>37</sup>	Case-cohort	3	2	2	7
Conceição et al., 2016 <sup>38</sup>	Case-control	3	2	2	7
Hardy et al., 1990 <sup>39</sup>	Case-control	3	2	2	7
Nomura et al., 1977 <sup>40</sup>	Case-control	4	2	2	8
Hislop and Elwood, 1981 <sup>41</sup>	Cohort	2	1	3	6
Minami et al., 1998 <sup>42</sup>	Case-control	4	2	2	8

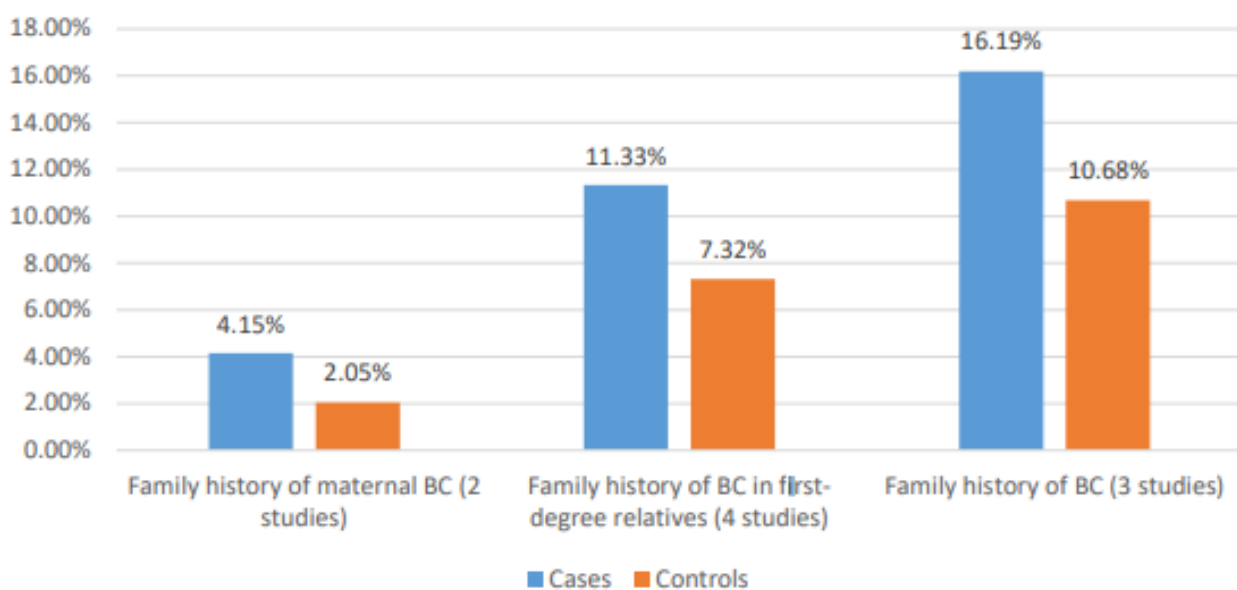

BC: breast cancer. Family history of maternal breast cancer included data from studies conducted by Hardy and colleagues<sup>39</sup>, and Nomura and colleagues<sup>40</sup>. Family history of breast cancer in first-degree relatives included data from four studies<sup>23,34,35,42</sup>. Family history of breast cancer (general) included three studies<sup>18,37,38</sup>.

**Figure 2.** Frequency of family history of breast cancer in cases and controls.

in this review, adding greater weight to the estimates found<sup>50</sup>. Most studies (92%) had moderate or high methodological quality ( $\geq 6$  stars). Only one study was considered of low quality, obtaining 4 stars<sup>21</sup>. One of the main limitations of the cohort study carried out by Berkey et al.<sup>21</sup> is the determination of the outcome, considering that the participants themselves reported breast biopsy diagnosis.

Literature has shown that other large cohort studies have used only the BBD<sup>51</sup> report itself, and the authors also mention a validation study carried out on a large cohort of women, some of whom are mothers of the participants (Nurses' Health Study II), confirming the accuracy of the BBD diagnosis reported by women<sup>52</sup>. Conversely, the limited statistical power of most case-control studies may be due to an insufficient sample to represent the real estimates, considering that the magnitudes of the associations were high.

Case-control studies that used women with nonproliferative lesions as a control group were excluded because the natural history of histological changes that compose benign breast diseases is still unclear. Studies that used this strategy aimed to identify the risk factors for benign lesions that confer a higher risk of breast cancer (proliferative and atypical lesions); nevertheless, it is unknown, for example, whether BBD regress to histological types with less proliferation or progress to types with greater proliferation and/or atypia<sup>53</sup>.

Visscher et al.<sup>53</sup> conducted a cohort study on 13,466 women aged between 18 and 85 years who underwent breast biopsy with benign findings, and those with an initial diagnosis of nonproliferative lesion and subsequent proliferative diagnosis had an increased risk of breast cancer (hazard ratio – HR = 1.77; 95%CI 1.06–2.94) compared with those who had no change in diagnosis. Thus, nonproliferative lesions could be part of the causal link that leads both to the development of lesions with more significant oncogenic potential and to breast cancer. In this case, women with such lesions might not be selected as controls in case-control studies. However, further studies are needed to confirm these causal links. Women who perform multiple biopsies with benign changes that progress in subsequent biopsies may have been subjected to the procedure of different breast regions, which in turn could result in hidden undiagnosed lesions instead of injuries that have progressed.

Among the limitations of this review, in case-control studies that presented only the number of women classified in each category (case and control) according to the presence or absence of family history, without having estimated the magnitude of the association, the authors of the present review calculated the risk estimates. The values of crude OR were calculated. More accurate estimates adjusted for potential covariates were not applied to these studies<sup>34,37,35,39,40</sup>, although most authors have paired cases and controls for age and other variables, as demonstrated in Chart 1.

In addition, the different BBD classification criteria and family history of breast cancer adopted by the studies made direct comparisons difficult. The oldest studies used specific types of lesions, such as: cystic disease, fibroadenoma, benign epithelial hyperplasia, and fibrocystic disease<sup>34,40</sup>; whereas the most recent ones used the proliferation and atypia degree-based classification model<sup>7</sup>. Furthermore, most studies (53%) were conducted on North American populations, mostly composed of Caucasian women, and studies on European and African populations were not found.

Therefore, further studies on populations covered by screening programs that use a standard BBD classification scheme and family history of breast cancer are necessary. Moreover, many studies that indicated a strong association between BBD and family history of breast cancer did not have enough power to exclude chance as a possible explanation for that result. Thus, studies with larger sample sizes are necessary to obtain more accurate estimates.

A better understanding of the role of family history of breast cancer in the risk of developing BBD will help to understand the factors and biological pathways that lead to the development of breast cancer, in addition to identifying whether women with BBD and family history of breast cancer could benefit from greater adherence to additional breast cancer screening or chemoprevention modalities.

## AUTHORS' CONTRIBUTION

M.S.: conceptualization, project management, formal analysis, interpretation, and writing.

I.S.: conceptualization, project management, writing, critical analysis, and review of the study.

Both authors approved the final version of the article.

## REFERENCES

1. IARC. Working Group on the Evaluation of Cancer-Preventive. Breast Cancer Screening [Internet]. IARC; 2016 [accessed on Oct. 10, 2019]. Available from: <https://publications.iarc.fr/Book-And-Report-Series/Iarc-Handbooks-Of-Cancer-Prevention/Breast-Cancer-Screening-2016>
2. Silverstein M. Where's the Outrage? *J Am Coll Surg*; 2009;208(1):78-9. <https://doi.org/10.1016/j.jamcollsurg.2008.09.022>
3. Gutwein LG, Ang DN, Liu H, Marshall JK, Hochwald SN, Copeland EM, et al. Utilization of minimally invasive breast biopsy for the evaluation of suspicious breast lesions. *Am J Surg*. 2011;202(2):127-32. <https://doi.org/10.1016/j.amjsurg.2010.09.005>
4. Santen RJ, Mansel R. Benign Breast Disorders. *N Engl J Med*. 2005;353(3):275-85. <https://doi.org/10.1056/NEJMra035692>

5. Porter GJR, Evans AJ, Lee AHS, Hamilton LJ, James JJ. Unusual benign breast lesions. *Clin Radiol.* 2006;61(7):562-9. <https://doi.org/10.1016/j.crad.2006.02.008>
6. Dyrstad SW, Yan Y, Fowler AM, Colditz GA. Breast cancer risk associated with benign breast disease: systematic review and meta-analysis. *Breast Cancer Res Treat.* 2015;149(3):569-75. <https://doi.org/10.1007/s10549-014-3254-6>
7. Dupont WD, Page DL. Risk Factors for Breast Cancer in Women with Proliferative Breast Disease. *N Engl J Med.* 1985;312(3):146-51. <https://doi.org/10.1056/NEJM198501173120303>
8. Collins LC, Baer HJ, Tamimi RM, Connolly JL, Colditz GA, Schnitt SJ. Magnitude and laterality of breast cancer risk according to histologic type of atypical hyperplasia: results from the Nurses' Health Study. *Cancer.* 2007;109(2):180-7. <https://doi.org/10.1002/cncr.22408>
9. Worsham MJ, Raju U, Lu M, Kapke A, Bottrell A, Cheng J, et al. Risk Factors for breast cancer from benign breast disease in a diverse population. *Breast Cancer Res Treat.* 2009;118(1):1-7. <https://doi.org/10.1007/s10549-008-0198-8>
10. Kabat GC, Jones JG, Olson N, Negassa A, Duggan C, Ginsberg M, et al. A multi-center prospective cohort study of benign breast disease and risk of subsequent breast cancer. *Cancer Causes Control.* 2010;21(6):821-8. <https://doi.org/10.1007/s10552-010-9508-7>
11. Nutter EL, Weiss JE, Marotti JD, Barth Jr. RJ, Eliassen S, Goodrich ME, et al. Personal history of proliferative breast disease with atypia and risk of multifocal breast cancer: Personal History of BBD and Risk of MFBC. *Cancer.* 2018;124(7):1350-7. <https://doi.org/10.1002/cncr.31202>
12. Shoker BS, Jarvis C, Clarke RB, Anderson E, Hewlett J, Davies MPA, et al. Estrogen Receptor-Positive Proliferating Cells in the Normal and Precancerous Breast. *Am J Pathol.* 1999;155(6):1811-5. [https://dx.doi.org/10.1016%2FS0002-9440\(10\)65498-3](https://dx.doi.org/10.1016%2FS0002-9440(10)65498-3)
13. Hartmann LC, Degnim AC, Santen RJ, Dupont WD, Ghosh K. Atypical Hyperplasia of the Breast — Risk Assessment and Management Options. *N Engl J Med.* 2015;372(1):78-89. <https://doi.org/10.1056/NEJMs1407164>
14. Lopez-Garcia MA, Geyer FC, Lacroix-Triki M, Marchi6 C, Reis-Filho JS. Breast cancer precursors revisited: molecular features and progression pathways. *Histopathology.* 2010;57(2):171-92. <https://doi.org/10.1111/j.1365-2559.2010.03568.x>
15. Bombonati A, Sgroi DC. The Molecular Pathology of Breast Cancer Progression. *J Pathol.* 2011;223(2):308-18. <https://doi.org/10.1002/path.2808>
16. Wellings SR, Jensen HM, Marcum RG. An atlas of subgross pathology of the human breast with special reference to possible precancerous lesions. *J Natl Cancer Inst.* 1975;55(2):231-73.
17. Rohan TE, Miller AB. Hormone replacement therapy and risk of benign proliferative epithelial disorders of the breast. *Eur J Cancer Prev.* 1999;8(2):123-30. <https://doi.org/10.1097/00008469-199904000-00006>
18. Galván-Portillo M, Sanchez LT, López-Carrillo L. Dietary and reproductive factors associated with benign breast disease in Mexican women. *Nutr Cancer.* 2002;43(2):133-40. [https://doi.org/10.1207/s15327914nc432\\_3](https://doi.org/10.1207/s15327914nc432_3)
19. Webb PM, Byrne C, Schnitt SJ, Connolly JL, Jacobs TW, Baer HJ, et al. A Prospective Study of Diet and Benign Breast Disease. *Cancer Epidemiol Prev Biomark.* 2004;13(7):1106-13.
20. Jung MM, Colditz GA, Collins LC, Schnitt SJ, Connolly JL, Tamimi RM. Lifetime physical activity and the incidence of proliferative benign breast disease. *Cancer Causes Control.* 2011;22(9):1297-305. <https://doi.org/10.1007/s10552-011-9803-y>
21. Berkey CS, Tamimi RM, Rosner B, Frazier AL, Colditz GA. Young women with family history of breast cancer and their risk factors for benign breast disease. *Cancer.* 2012;118(11):2796-803. <https://doi.org/10.1002/cncr.26519>
22. Webb PM, Byrne C, Schnitt SJ, Connolly JL, Jacobs T, Peiro G, et al. Family history of breast cancer, age and benign breast disease. *Int J Cancer.* 2002;100(3):375-8. <https://doi.org/10.1002/ijc.10490>
23. Wu C, Ray RM, Lin MG, Gao DL, Horner NK, Nelson ZC, et al. A Case-Control Study of Risk Factors for Fibrocystic Breast Conditions: Shanghai Nutrition and Breast Disease Study, China, 1995-2000. *Am J Epidemiol.* 2004;160(10):945-60. <https://doi.org/10.1093/aje/kwh318>
24. Michailidou K, Beesley J, Lindstrom S, Canisius S, Dennis J, Lush MJ, et al. Genome-wide association analysis of more than 120,000 individuals identifies 15 new susceptibility loci for breast cancer. *Nat Genet.* 2015;47(4):373-80. <https://doi.org/10.1038/ng.3242>
25. Hopper JL, Chenevix-Trench G, Jolley DJ, Dite GS, Jenkins MA, Venter DJ, et al. Design and analysis issues in a population-based, case-control-family study of the genetic epidemiology of breast cancer and the Co-operative Family Registry for Breast Cancer Studies (CFRBCS). *J Natl Cancer Inst Monogr.* 1999;(26):95-100. <https://doi.org/10.1093/oxfordjournals.jncimonographs.a024232>
26. De Coster S, van Larebeke N. Endocrine-disrupting chemicals: associated disorders and mechanisms of action. *J Environ Public Health.* 2012;2012:713696. <https://doi.org/10.1155/2012/713696>
27. Gray JM, Rasanayagam S, Engel C, Rizzo J. State of the evidence 2017: an update on the connection between breast cancer and the environment. *Environ Health.* 2017;16:94. <https://doi.org/10.1186/s12940-017-0287-4>
28. NCCN. Genetic/familial high-risk assessment: breast and ovarian. NCCN; 2018.
29. Zhou W-B, Xue D-Q, Liu X-A, Ding Q, Wang S. The influence of family history and histological stratification on breast cancer risk in women with benign breast disease: a meta-analysis. *J Cancer Res Clin Oncol.* 2011;137(7):1053-60. <https://doi.org/10.1007/s00432-011-0979-z>
30. Goehring C, Morabia A. Epidemiology of benign breast disease, with special attention to histologic types. *Epidemiol Rev.* 1997;19(2):310-27. <https://doi.org/10.1093/oxfordjournals.epirev.a017960>
31. Silvera SAN, Rohan TE. Benign proliferative epithelial disorders of the breast: a review of the epidemiologic evidence. *Breast Cancer Res Treat.* 2008;110(3):397-409. <https://doi.org/10.1007/s10549-007-9740-3>
32. Moher D, Liberati A, Tetzlaff J, Altman DG, Prisma Group. Preferred Reporting Items for Systematic Reviews and Meta-Analyses: The PRISMA Statement. *PLoS Med.* 2009;6(7):e1000097. <https://doi.org/10.1371/journal.pmed.1000097>

33. Wells G, Shea B, O'Connell D, Peterson J, Welch V, Losos M, et al. The Newcastle-Ottawa Scale (NOS) for assessing the quality of nonrandomised studies in meta-analyses [Internet]. 2019 [accessed on Oct. 11, 2019]. Available from: [http://www.ohri.ca/programs/clinical\\_epidemiology/oxford.asp](http://www.ohri.ca/programs/clinical_epidemiology/oxford.asp)
34. Ingram DM, Nottage E, Roberts T. The role of diet in the development of breast cancer: a case-control study of patients with breast cancer, benign epithelial hyperplasia and fibrocystic disease of the breast. *Br J Cancer*. 1991;64(1):187-91. <https://doi.org/10.1038/bjc.1991.268>
35. Catsburg C, Gunter MJ, Chen C, Cote ML, Kabat GC, Nassir R, et al. Insulin, Estrogen, Inflammatory Markers, and Risk of Benign Proliferative Breast Disease. *Cancer Res*. 2014;74(12):3248-58. <https://doi.org/10.1158/0008-5472.CAN-13-3514>
36. Bright RA, Morrison AS, Brisson J, Burstein NA, Sadowsky NL, Kopans DB, et al. Histologic and mammographic specificity of risk factors for benign breast disease. *Cancer*. 1989;64(3):653-7. [https://doi.org/10.1002/1097-0142\(19890801\)64:3<653::AID-CNCR2820640315>3.0.CO;2-O](https://doi.org/10.1002/1097-0142(19890801)64:3<653::AID-CNCR2820640315>3.0.CO;2-O)
37. Rohan TE, Jain M, Miller AB. A case-cohort study of diet and risk of benign proliferative epithelial disorders of the breast (Canada). *Cancer Causes Control*. 1998;9(1):19-27.
38. Conceição LL da, Dias MDM, Pessoa MC, Pena GG, Mendes MCS, Neves CVB, et al. Difference in fatty acids composition of breast adipose tissue in women with breast cancer and benign breast disease. *Nutr Hosp*. 2016;33(6):1354-60. <https://doi.org/10.20960/nh.795>
39. Hardy EE, Pinotti JA, Osis MJ, Faúndes A. Variáveis reprodutivas e risco para doenças benignas de mama: estudo caso controle. *Rev Saúde Pública*. 1990;24(5):387-93. <https://doi.org/10.1590/S0034-89101990000500006>
40. Nomura A, Comstock GW, Tonascia JA. Epidemiologic characteristics of benign breast disease. *Am J Epidemiol*. 1977;105(6):505-12. <https://doi.org/10.1093/oxfordjournals.aje.a112413>
41. Hislop TG, Elwood JM. Risk factors for benign breast disease: a 30-year cohort study. *Can Med Assoc J*. 1981;124(3):283-91.
42. Minami Y, Ohuchi N, Taeda Y, Fukao A, Hisamichi S. Risk factors for benign breast disease according to histopathological type: comparisons with risk factors for breast cancer. *Jpn J Cancer Res Gann*. 1998;89(2):116-23. <https://doi.org/10.1111/j.1349-7006.1998.tb00538.x>
43. Bao P-P, Zheng Y, Wu C-X, Huang Z-Z, Gao Y-T, Jin F, et al. Cancer incidence in urban Shanghai, 1973-2010: an updated trend and age-period-cohort effects. *BMC Cancer*. 2016;16:284. <https://doi.org/10.1186/s12885-016-2313-2>
44. Tavassoli FA, Devilee P, eds. *Pathology and Genetics of Tumours of the Breast and Female Genital Organs*. IARC Press; 2003.
45. Fidler MM, Gupta S, Soerjomataram I, Ferlay J, Steliarova-Foucher E, Bray F. Cancer incidence and mortality among young adults aged 20–39 years worldwide in 2012: a population-based study. *Lancet Oncol*. 2017;18(12):1579-89. [https://doi.org/10.1016/S1470-2045\(17\)30677-0](https://doi.org/10.1016/S1470-2045(17)30677-0)
46. Scowitz ML, Menezes AMB, Gigante DP, Tessaro S. Conduas na prevenção secundária do câncer de mama e fatores associados. *Rev Saúde Pública*. 2005;39(3):340-9. <https://doi.org/10.1590/S0034-89102005000300003>
47. Haut ER, Pronovost PJ. Surveillance bias in outcomes reporting. *JAMA*. 2011;305(23):2462-3. <https://doi.org/10.1001/jama.2011.822>
48. Hennekens CH, Buring JE. *Epidemiology in Medicine*. Boston: Little, Brown and Co.; 1987.
49. Rothman KJ, Greenland S, Lash TL. *Epidemiologia Moderna* [Internet]. 3ª ed. Porto Alegre: Artmed; 2011 [accessed on Oct. 17, 2019]. Available from: <https://www.livrariaflorence.com.br/produto/livro-epidemiologia-moderna-rothman-134984>
50. Salamat F, Niakan B, Keshtkar A, Rafiei E, Zendeheel M. Subtypes of benign breast disease as a risk factor of breast cancer: A systematic review and meta analyses. *Iran J Med Sci*. 2018;43(4):355-64.
51. Zeinomar N, Phillips K-A, Daly MB, Milne RL, Dite GS, MacInnis RJ, et al. Benign breast disease increases breast cancer risk independent of underlying familial risk profile: Findings from a Prospective Family Study Cohort. *Int J Cancer*. 2019;145(2):370-9. <https://doi.org/10.1002/ijc.32112>
52. Su X, Colditz GA, Willett WC, Collins LC, Schnitt SJ, Connolly JL, et al. Genetic Variation and Circulating Levels of IGF-I and IGFBP-3 in Relation to Risk of Proliferative Benign Breast Disease. *Int J Cancer*. 2010;126(1):180-90. <https://doi.org/10.1002/ijc.24674>
53. Visscher DW, Frank RD, Carter JM, Vierkant RA, Winham SJ, Heinzen EP, et al. Breast Cancer Risk and Progressive Histology in Serial Benign Biopsies. *JNCI J Natl Cancer Inst*. 2017;109(10):dix035. <https://doi.org/10.1093/jnci/dix035>



# Complex fibroadenoma: bibliometric literature review and presentation of a clinical case

Ana Beatriz Aguiar Cardoso<sup>1</sup> , Gabriele Cristina Schröder<sup>1</sup> , Polyanna Zimmermann<sup>1\*</sup> ,  
Thiago Santos Lima Almendra<sup>2</sup> , Antonione Santos Bezerra Pinto<sup>1</sup> 

## ABSTRACT

Fibroadenomas (FAs) are benign fibro-epithelial tumours of the breast characterized by being biphasic and having stromal and epithelial components. It is estimated that FAs affect more than 20 percent of the general population aged 16–40 years old. Complex FAs are a sub-type of fibroadenoma presenting one or more pathological characteristics, such as epithelial calcifications, apocrine metaplasias, sclerosing adenoma and cysts larger than 3 mm. According to studies elsewhere, women with complex FAs are 3.1 times more likely to develop breast cancer. The objective of the present study was to map the scientific production of articles on complex FA in the international literature. The ISI Web of Knowledge (Web of Science), one of the main scientific databases in the world, was searched with the following terms: (“complex” and “fibroadenoma”) or (“fibroadenoma” and “complex”). Only articles published between 1981 and 2019 were considered for a bibliometric review, in which 160 articles from 126 different periodicals were identified after using refinement filters. Moreover, a clinical case was also discussed based on the patient’s medical record and interview.

**KEYWORDS:** diagnosis; fibroadenoma; therapeutics.

## INTRODUCTION

Fibroadenomas (FAs) are benign fibro-epithelial tumours of the breast,<sup>1</sup> characterized by being biphasic and having stromal and epithelial components.<sup>2</sup> They develop in the lobular unit of the terminal duct<sup>3</sup> and affect mainly adolescent girls and adult young women. FAs occur with high incidence in the second and third decades of life,<sup>4</sup> although they may also occur at any age.<sup>2</sup>

FAs are asymptomatic in about 25% of cases, multiple in 13%–15% and bilateral in 10%–15% of them, being more common in the left breast and predominantly located in the superior-lateral quadrants. Estimates believe that more than 20% of the female population aged 16–40 years old is affected, but a higher number confirming that nodules are often asymptomatic should be expected to be seen.<sup>5</sup>

FAs are stimulated by estrogen, progesterone, gestation and lactation, and become atrophied in the menopause period<sup>6</sup>. In most cases, they present as mammary masses not greater than 3–4 cm. In addition to its usual form of presentation, FAs may uncommonly occur in the juvenile, giant, extra-mammary and complex forms.<sup>7</sup>

The pathogenesis of FA is still not clear. However, an association with high expression of the B-cell lymphoma gene (BCL-2) in epithelial cells of FA was discovered. In addition, there is also a relation with the mutation in the mediator complex subunit 12 gene (MED12), located on the chromosome X in stroma cells.<sup>5</sup>

Complex FAs are a sub-type of fibroadenoma, and they have one or more pathological characteristics. Both complex and simple FAs frequently show single nodules in parallel to the skin surface.<sup>3</sup>

As to size, complex FAs are smaller than simple ones.<sup>6</sup> This occurs because FAs tend to recede with age, lose cellularity and acquire complex histopathological features.<sup>3</sup>

According to a study, women with complex FAs are 3.1 times more likely to develop invasive breast cancer compared to the general population.<sup>1,6</sup> This risk remains high for at least 20 years after diagnosis,<sup>1</sup> which leads to the need of following up the patient longitudinally.

Treating of FAs can range depending on the patient’s age and nodule’s size. Because of this, the present study is aimed at conducting a bibliometric review of the literature on complex

<sup>1</sup>Faculdade de Ciências Humanas, Exatas e da Saúde do Piauí/Instituto de Educação Superior do Vale do Parnaíba – Parnaíba (PI), Brazil.

<sup>2</sup>Universidade Federal do Delta do Parnaíba – Parnaíba (PI), Brazil.

\*Corresponding author: polyanna\_zimmermann@hotmail.com

Conflict of interests: nothing to declare.

Received on: 08/04/2020. Accepted on: 09/30/2020.

FA, in addition to showing a clinical case based on imaging and anatomopathological characteristics of the disease.

## METHODS

The present study is a bibliometric review aimed at quantifying the written communication process by using statistics and mathematics so that a quantitative basis can be provided to date back to documentary information.<sup>8</sup> In addition, the scientific production on complex FA in international literature was also mapped. The ISI Web of Knowledge (Web of Science), one of the main scientific databases in the world, was searched with the following terms: (“complex” and “fibroadenoma”) or (“fibroadenoma” and “complex”). Only articles published between 1981 and 2019 were included for a bibliometric literature review on the theme. The methodology used refinement filters to identify related articles on the ISI Web of Knowledge database, in which 160 ones were from 126 different journals. Only articles and reviews were included, whereas editorials, book chapters, and event publications were excluded. The main results of this analysis were the number of studies in progress, the top journals on the theme, and the most cited articles.

The present study also described a clinical case report based on the patient’s medical record and interview, including diagnostic methods and treatments used. The patient was asked to sign an informed consent form, according to the Brazilian norms and regulations on human research, including Resolutions No. 466/12 and 510/16 of the National Health Council (CNS). This study was approved by the Research Ethics Committee of Instituto Tocantinense Presidente Antonio Carlos (UNTPAC), according to Protocol No. 3838142.

## RESULTS

After the bibliographic review on the ISI Web of Knowledge (Web of Science) database, a total of 160 articles on fibroadenoma was identified. These articles were published in 126 different journals indexed on this database and written by 911 authors, linked to 287 institutions located in 45 countries. All these articles used 4,157 references, approximately 26 each, on average. Table 1 lists the results below.

**Table 1.** General results of bibliometric review (1981–2019).

Bibliometric data	Quantity
Publications (articles)	160
Indexed journals	126
Authors	911
Institutions (links of authors)	287
Countries	45
Cited references	4,157

Although this bibliographic review has been performed for the 1945–2019 period (full years only), the first article was only published in 1981 and publications on the theme increased from 1991 onwards (Figure 1 and Table 2). Considering all the years in which there was a publication, approximately five articles were published per year, on average.

Table 3 shows the journals with the highest quantity of published articles, highlighting the Journal of Ultrasound in Medicine. The other journals that ranked from 9<sup>th</sup> to 21<sup>st</sup> had two articles; and those that ranked from 22<sup>nd</sup> onwards had only one article.

Table 4 shows the ranking of authors with the highest number of published articles and their total citations. The other authors that ranked from 8<sup>th</sup> to 62<sup>nd</sup> had two articles published, whereas those that ranked from 63<sup>rd</sup> onwards had only one.

As to the number of articles published per country and according to each author’s institution (Table 5), the United States leads the list of research as they account for 30% of the total number of publications.

Of the 160 articles reviewed, 31 were cited at least 40 times and selected according to the parameters of the software VOSviewer.

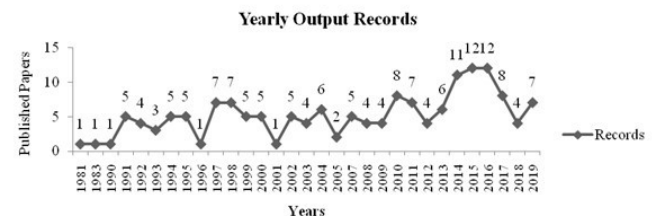

**Figure 1.** Yearly records of published articles (1981–2019).

**Table 2.** Yearly records of published articles (1981–2019).

Years	Articles	Citations	Year	Articles	Citations
1981	1	66	2004	6	186
1983	1	4	2005	2	81
1990	1	170	2007	5	723
1991	5	243	2008	4	69
1992	4	203	2009	4	125
1993	3	118	2010	8	157
1994	5	529	2011	7	115
1995	5	206	2012	4	28
1996	1	24	2013	6	41
1997	7	131	2014	11	221
1998	7	155	2015	12	179
1999	5	83	2016	12	171
2000	5	189	2017	8	17
2001	1	64	2018	4	2
2002	5	130	2019	7	9
2003	4	202			



**Table 3.** Top journals with the most articles published (1981–2018).

Journals	Number of articles	Citations	Citations/Quantity
<i>Journal of Ultrasound in Medicine</i>	5	52	10.4
<i>Breast Cancer Research and Treatment</i>	4	71	17.75
<i>Histopathology</i>	4	145	36.25
<i>International Journal of Cancer</i>	4	220	55
<i>American Journal of Surgical Pathology</i>	3	135	45
<i>Asian Pacific Journal of Cancer Prevention</i>	3	22	7.33
<i>Journal of Pathology</i>	3	254	84.67
<i>Pediatric Radiology</i>	3	40	13.33

**Table 4.** Authors with the most articles published (1980–2018).

Authors	Articles	Citations	Affiliation (link institutions)	Country
Kim SJ	4	7	Myongji Hospital	South Korea
Reis JS	4	169	Memorial Sloan-Kettering Cancer Center	USA
Tan PH	4	194	Singapore General Hospital	Singapore
Broggi E	3	133	Memorial Sloan-Kettering Cancer Center	USA
Carney JÁ	3	135	Georgetown University	USA
de las Mulas JM	3	42	National University of Cordoba	Spain
Millan Y	3	42	National University of Cordoba	Spain

**Table 5.** Number of articles by country of origin of the authors' link institutions.

Country	Amount	Citations
USA	47	2.802
Italy	10	229
UnitedKingdom	10	647
France	8	147
Germany	7	57
Taiwan	7	60
Brazil	6	143
India	6	11
Japan	6	181
China	6	191

Of these, 11 articles had citations between each other and are shown in Figure 2.

As to the most cited articles, Dupont et al.,<sup>1</sup> Lim et al.<sup>9</sup> and Tan et al.<sup>10</sup> (Table 6) are highlighted.

Fibroadenoma, carcinoma, cancer, expression, and lesions were among the most cited keywords in publications (Figure 3).

### CASE REPORT

A 26-year-old single black woman sought specialized medical care in October 2019 due to the presence of a nodule in her right breast for one year. There was absence of pain and phlogistic sings, but the nodule had recently grown. Clinical history revealed that the patient had no chronic disease, nor history of smoking, alcoholism or use of continuous medication. Menarche occurred at 11 years old and there was no family history of cancer. Complementary examinations were asked after the patient was clinically examined.

Ultrasonography (USG) of the breast was performed on 16<sup>th</sup> October 2019, revealing the presence of two nodules in her right

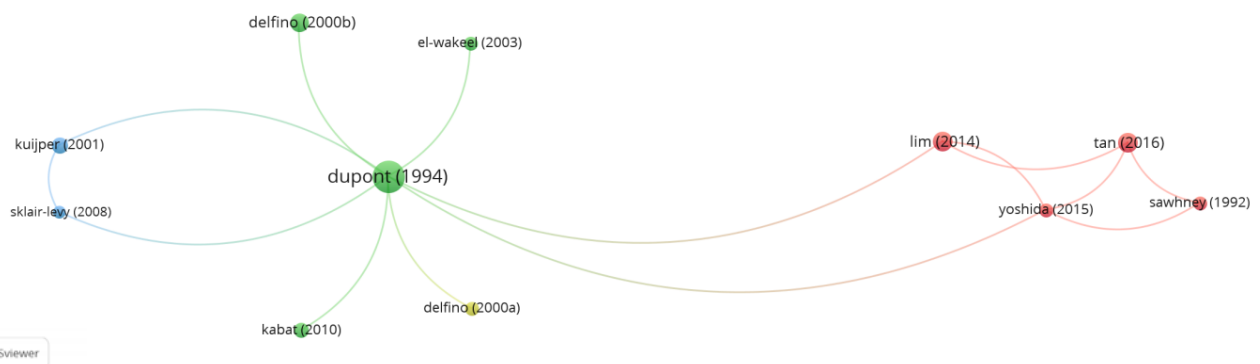

**Figure 2.** Most cited and most related articles (1981–2019).

**Table 6.** Most cited articles.

Authors/year	Title	Source	Citations
Dupont et al. (1994) <sup>1</sup>	"Long-term risk of breast cancer in women with fibroadenoma"	<i>New England Journal of Medicine</i>	240
Kuijper et al. (2001) <sup>2</sup>	"Histopathology of fibroadenoma of the breast"	<i>American Journal of Clinical Pathology</i>	64
Sklair-Levy et al. (2008) <sup>6</sup>	"Incidence and management of complex fibroadenomas"	<i>American Journal of Roentgenology</i>	43
Lim et al. (2014) <sup>9</sup>	"Exome sequencing identifies highly recurrent med12 somatic mutations in breast fibroadenoma"	<i>Nature Genetics</i>	91
Tan et al. (2016) <sup>10</sup>	"Phyllodes tumours of the breast: a consensus review"	<i>Histopathology</i>	90
Delfino et al. (2000) <sup>11</sup>	"Breast cancer, passive and active cigarette smoking and n-acetyltransferase 2 genotype"	<i>Pharmacogenetics</i>	46
Delfino et al. (2000) <sup>12</sup>	"Breast cancer, heterocyclic aromatic amines from meat and n-acetyltransferase 2 genotype"	<i>Carcinogenesis</i>	80
El-Wakeel e Umpleby (2003) <sup>13</sup>	"Systematic review of fibroadenoma as a risk factor for breast cancer"	<i>Breast</i>	44
Kabat et al. (2010) <sup>14</sup>	"A multi-center prospective cohort study of benign breast disease and risk of subsequent breast cancer"	<i>Cancer Causes &amp; Control</i>	56
Yoshida et al. (2015) <sup>15</sup>	"Frequent med12 mutations in phyllodes tumours of the breast"	<i>British Journal of Cancer</i>	47
Sawhney et al. (1992) <sup>16</sup>	"Epithelial-stromal interactions in tumors. A morphologic study of fibroepithelial tumors of the breast"	<i>Cancer</i>	

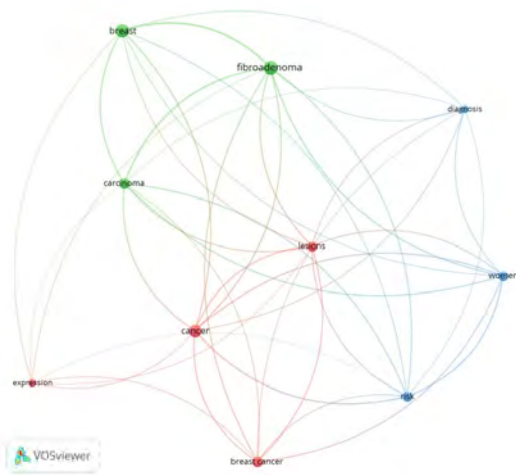
**Figure 3.** Co-occurrence of the most cited and most related keywords (1981–2019).

breast. One nodule was oval-shaped, circumscribed, hypoechoic, measuring  $3.1 \times 1.9 \times 2.9$  cm, located in parallel to the skin surface at the junction of the upper quadrants of the breast and in 12-hour position (Figure 4). The other nodule was oval-shaped, micro-lobulated, hypoechoic, measuring  $3.0 \times 1.7 \times 2.6$  cm located at the lower-lateral quadrant of the breast and in 8-hour position (Figure 5). Axillary lymph nodes had usual appearance. Based on the Breast Imaging Reporting and Data System (BI-RADS) classification, examination indicated that the lesion was suspected to be highly malignant and suggested biopsy of the nodule in the 8-hour position.

Core biopsy of the micro-lobulated nodule was performed on 22<sup>nd</sup> October 2019. Histological sections revealed the presence of benign fibro-epithelial neoplasm compatible with complex FA (Figure 6).

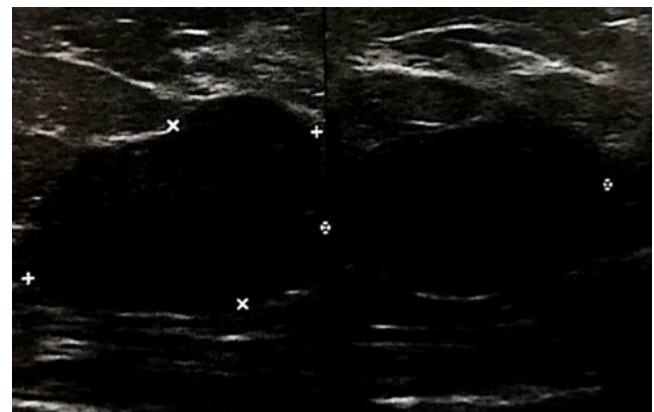
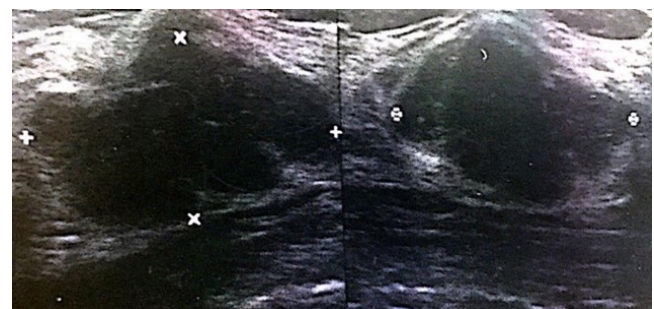
**Figure 4.** Ultrasonography of the right breast, showing oval-shaped, circumscribed, hypoechoic nodule, measuring  $3.1 \times 1.9 \times 2.9$  cm, located in parallel to the skin surface at the junction of the upper quadrants.**Figure 5.** Ultrasonography of the right breast showing oval-shaped, circumscribed, micro-lobulated nodule, measuring  $3.0 \times 1.7 \times 2.6$  cm, located at the lower-lateral quadrant.

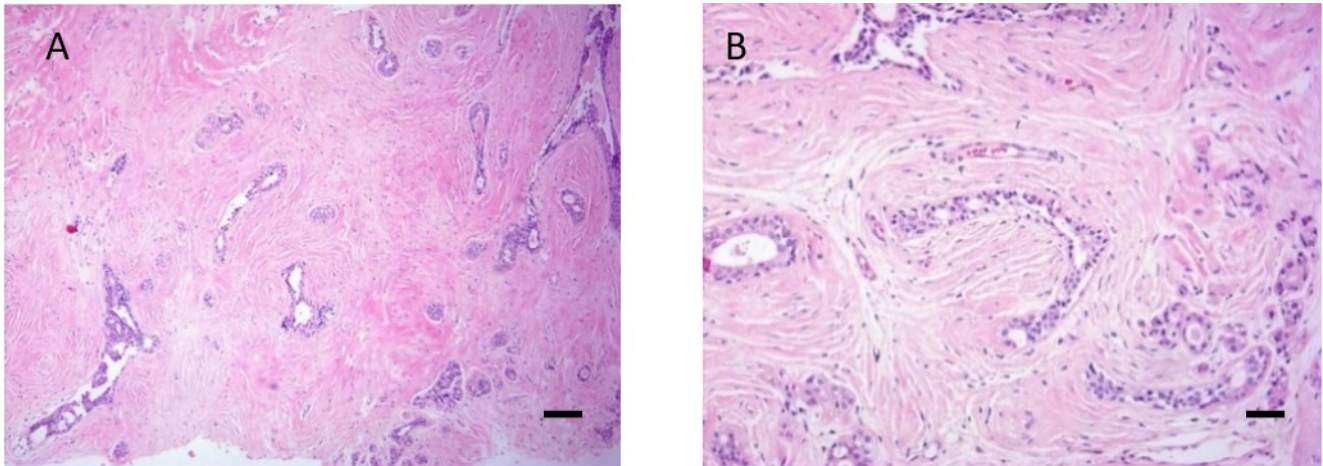

**Figure 6.** A (100x magnification) and B (400x magnification): Microphotograph of the nodule stained with haematoxylin & eosin, revealing benign fibro-epithelial neoplasm, characterized by ductile proliferation with an intra- and peri-canalicular pattern and collagenized stroma.

After diagnostic confirmation, the patient was referred to an oncological surgeon for evaluation. The surgeon opted for performing two surgeries on different days, due to lack of proximity of the nodules and to avoid necrosis of the papilla with areole incision. The surgeries were held on 1<sup>st</sup> December 2019 and 21<sup>st</sup> January 2020. The biopsy was repeated after removal of the nodules, confirming the diagnosis of complex FA.

## DISCUSSION

After the bibliographic review, high-quality articles indexed on the Web of Science database could be found, and having an overview of the scientific production in the world was possible, showing that there are only 160 studies on fibroadenoma. As to the evolution of publications per year, the first article was published in 1981, and that the number of these studies increased significantly from 1991 onwards, with five publications yearly, on average.

Most studies are published in foreign journals, highlighting the Journal of Ultrasound in Medicine, which has the highest number of published articles. As to the number of published articles by country and according to the author's institutional links, the United States leads the list of studies as they account for almost 30% of all publications. Among the authors with the most cited articles, Dupont et al.,<sup>1</sup> Lim et al.<sup>9</sup> and Tan et al.<sup>10</sup> are highlighted.

In the present clinical case, the patient was 26 years old, which coincided with the most affected age group, as reported in the literature. Nevertheless, one of the FAs found was located in the right breast at the junction of the upper quadrants in 12-hour position, and the other was at the lower-lateral quadrant in 8-hour position, which is not consistent with the usual findings in literature.

Complex FAs are a sub-type of fibroadenoma, presenting one or more pathological characteristics, such as epithelial calcifications, apocrine metaplasias, sclerosing adenoma, and cysts larger than 3 mm. Among the most frequent characteristics, irregular shape, complex echo-structure with anechoic and echogenic

components, including non-circumscribed contours, which can be micro-lobulated, indistinct, spiculated, and angular are mentioned. Some characteristics reported in literature coincide with those found in the patient's nodules, such as micro-lobulation (nodule in 8-hour position) and parallel orientation to the skin surface (nodule in 12-hour position), whereas others diverge, such as the presence of more than one nodule.

In the present clinical case, the patient's nodule classified as complex, based on a histopathological evaluation, which showed smaller measurements (3.0 × 1.7 × 2.6 cm) compared to those of a simple FA (3.1 × 1.9 × 2.9 cm). The volume of FAs can increase by 16% per month in women younger than 50, whereas in older women the volume increases by 13%, or 20% in all dimensions during six months in women of all ages. Although this growth does not necessarily mean a process of malignancy, surgical excision is recommended if these dimensions are exceeded.<sup>17</sup>

As to pathogenesis, there is a relation with an increased expression of the BCL-2 gene, which accounts for apoptosis prevention.<sup>5</sup> This maintains the balance between cell proliferation and programmed cell death, which is the mechanism by which cells with damaged DNA are removed without causing any harm.<sup>18</sup>

Moreover, MED12 has been reported to be one of the most frequently mutated genes in FAs, located on chromosome Xq13.1. The high frequency of MED12 mutations in fibro-epithelial tumours suggests that it is a somatic gene leading to fibro-epithelial tumorigenesis. Mutations were reported in the exon-2 of MED12 gene, which encodes a protein interacting with proteins CDK8 (human protein kinase), CDK19, CYCC, and MED13. This protein interaction forms a complex for mediating the RNA polymerase II, which participates in the regulation of transcription and consequently in the development of FA. Besides that, codon 44 was found to be highly mutated and representing 86% of the mutations of FA.<sup>19</sup>

The management of younger patients is usually more conservative when clinical, histological, and imaging criteria, including thick-needle aspiration biopsy, suggest a benign lesion. Lesions

characterized by BI-RADS 2 follow a screening routine, whereas those characterized by BI-RADS 3 require a six-month ultrasound follow-up if lesions had been ultrasonographically observed, or a mammographic follow-up if lesions had been mammographically observed. FAs with no atypical findings can be monitored with mammography or ultrasound twice a year, for two years and, then once a year.<sup>6</sup>

Performing a percutaneous biopsy is recommended to confirm the histological diagnosis if the following findings are present: inconclusive ultrasound findings (BI-RADS 4); evidence of growth trend (clinically and ultrasonographically); new palpable mass during menopause; solid mass found in a patient with risk factors (positive family risk and/or BRCA mutation); and mammography showing mass with suspicious micro-calcifications<sup>20</sup>. In this way, excisional biopsy is indicated when histopathological biopsy reveals a high-risk lesion to rule out possible malignancy.

In the present case, ultrasonography showed presence of the BI-RADS 4 lesion. In category 4, although lesions did not have the morphological characteristics typically seen in cancer, they may be malignant, thus justifying a biopsy.<sup>21</sup> The diagnosis of complex FA was achieved after analysis of the biopsied material.

Mammography has a sensitivity of 85%–95% and can be used for primary diagnosis of FA, but its specificity is lower. Seen that, other diagnostic methods must be used.<sup>22</sup> In the present case, ultrasonography was chosen because young patients present dense breasts, which makes it difficult to visualize nodules on mammogram.

Studies demonstrate that sound-elastography can be used as a complementary diagnosis to evaluate unclear breast masses, such as fibroadenomas, thus contributing to the follow-up and clinical management of patients. However, combining BI-RADS classification with elastography is needed for a more effective management.<sup>23</sup>

Treating this pathology can vary depending on the patient's age and nodule's dimensions. In general, simple removal is performed when the nodule is larger than 2 cm. Smaller nodules are only clinically followed up every six months, as well as in patients younger than 25. Removal is indicated only in cases of rapid growth and in women older than 35.<sup>7</sup>

In the case reported, removal of the nodules was indicated due to their dimensions. Because patients diagnosed with complex FAs are 3.1 times more likely to develop invasive breast cancer and because the risk remains high for at least 20 years after diagnosis,<sup>1,6</sup> a longitudinal follow-up of the patient with ultrasonography was indicated every six months.

## FINAL CONSIDERATIONS

This present bibliometric literature review has allowed us to discuss on 160 articles, which addressed the theme of complex fibroadenoma on different occasions. From the characterization and analysis of the above-cited articles, evidence states that there are gaps in the production of knowledge on FAs, because there are only a few studies investigating the theme in depth.

By analyzing the bibliometric aspects of scientific production, health care professionals and researchers can understand the characteristics of the published articles. Moreover, further investigations and new studies are extremely necessary as complex FA is still widely unknown by general practitioners in the medical practice.

Clinical case study facilitates a better understanding of complex FAs in various contexts, such as clinical characteristics, imaging examinations, and histopathological aspects, which can help the health care professional to make the pathology diagnosis.

## ACKNOWLEDGMENTS

First, we thank God, for always giving us opportunities, strength and courage to overcome all challenges. We also thank our advisor, Prof. Antonione Santos Bezerra Pinto, for the support, guidance, and friendship. Dr. Thiago Santos Lima Almendra, for the presentation and assistance of the case reported. Our parents, for all the support, patience, understanding, and for all the help in achieving our dreams. Our brothers, for always being present in our lives, supporting us and encouraging us in our academic activities. Our friends, for helping us and always being by our side, always, be it during studies, research, or leisure. And for all the people who, directly or indirectly, contributed to our work.

## AUTHORS' CONTRIBUTION

A.C.: conceptualization, methodology, formal analysis, investigation, writing original draft.

G.S.: conceptualization, data curation, writing original draft, writing review & editing.

P.Z.: conceptualization, data curation, writing original draft, writing review & editing.

A.P.: supervision, project administration, formal analysis, writing review.

T.A.: supervision, project administration, formal analysis, writing review.

## REFERENCES

1. Dupont WD, Page DL, Parl FF, Vnencak-Jones CL, Plummer Jr. WD, Rados MS, et al. Long-term risk of breast cancer in women with fibroadenoma. *New Engl J Med* [Internet]. 1994 [accessed on Sept. 13, 2019];331(1):10-5. Available at: <https://www.ncbi.nlm.nih.gov/pubmed/8202095> <https://doi.org/10.1056/nejm199407073310103>
2. Kuijper A, Mommers EC, van der Wall E, van Diest PJ. Histopathology of fibroadenoma of the breast. *Am J Clin Pathol* [Internet]. 2001 [accessed on Sept. 2, 2019];115(5):736-42. Available at: <https://www.ncbi.nlm.nih.gov/pubmed/11345838> <https://doi.org/10.1309/f523-fmjv-w886-3j38>

3. Pinto J, Aguiar AT, Duarte H, Vilaverde F, Rodrigues A, Krug JL. Simple and Complex Fibroadenomas. Are There Any Distinguishing Sonographic Features? *J Ultrasound Med* [Internet]. 2014 [accessed on Sept. 13, 2019];33(3):415-9. Available at: <https://www.ncbi.nlm.nih.gov/pubmed/24567452> <https://doi.org/10.7863/ultra.33.3.415>
4. Ohashi R, Matsubara M, Watarai Y, Yanagihara K, Yamashita K, Tsuchiya S-I, et al. Cytological features of complex type fibroadenoma in comparison with non-complex type fibroadenoma. *Breast Cancer* [Internet]. 2016 [accessed on Sept. 2, 2019];23(5):724-31. Available at: <https://www.ncbi.nlm.nih.gov/pubmed/26249102> <https://doi.org/10.1007/s12282-015-0632-9>
5. Almeida ACO. Fibroadenomas Mamários – que entidade?: artigo de revisão [dissertation] [Internet]. Coimbra: Faculdade de Medicina, Universidade de Coimbra; 2015 [accessed on Sept. 17, 2019]. Available at: [https://estudogeral.uc.pt/bitstream/10316/31286/1/Trabalho%20final%206%C2%BAano\\_%20Fibroadenomas%20Mam%C3%A1rios.pdf](https://estudogeral.uc.pt/bitstream/10316/31286/1/Trabalho%20final%206%C2%BAano_%20Fibroadenomas%20Mam%C3%A1rios.pdf)
6. Sklair-Levy M, Sella T, Alweiss T, Craciun I, Libson E, Mally B. Incidence and Management of Complex Fibroadenomas. *Am J Roentgenol* [Internet]. 2008 [accessed on Sept. 11, 2019];190(1):214-8. Available at: <https://www.ncbi.nlm.nih.gov/pubmed/18094314> <https://doi.org/10.2214/ajr.07.2330>
7. Nazário ACP, Rego MF, Oliveira VM. Nódulos benignos da mama: uma revisão dos diagnósticos diferenciais e conduta. *Rev Bras Ginecol Obstet* [Internet];2007 [accessed on Sept. 17, 2019];29(4):211-9. Available at: [http://www.scielo.br/scielo.php?pid=S0100-72032007000400008&script=sci\\_abstract&tlng=pt](http://www.scielo.br/scielo.php?pid=S0100-72032007000400008&script=sci_abstract&tlng=pt) <https://doi.org/10.1590/S0100-72032007000400008>
8. Pao ML. Concepts of information retrieval. Englewood: Libraries Unlimited; 1989. 285 p.
9. Lim WK, Ong CK, Tan J, Thike AA, Ng CC, Rajasegaran V, et al. Exome sequencing identifies highly recurrent MED12 somatic mutations in breast fibroadenoma. *Nat Genet*. 2014;46(8):877-80. <https://doi.org/10.1038/ng.3037>
10. Tan BY, Acs G, Apple SK, Badve S, Bleiweiss IJ, Brogi E, et al. Phyllodes tumours of the breast: a consensus review. *Histopathology*. 2016;68(1):5-21. <https://dx.doi.org/10.1111%2Fhis.12876>
11. Delfino RJ, Smith C, West JG, Lin HJ, White E, Liao SY, et al. Breast cancer, passive and active cigarette smoking and N-acetyltransferase 2 genotype. *Pharmacogenetics*. 2000;10(5):461-9. <https://doi.org/10.1097/00008571-200007000-00009>
12. Delfino RJ, Sinha R, Smith C, West J, White E, Lin HJ, et al. Breast cancer, heterocyclic aromatic amines from meat and N-acetyltransferase 2 genotype. *Carcinogenesis*. 2000;21(4):607-15. <https://doi.org/10.1093/carcin/21.4.607>
13. El-Wakeel H, Umpleby HC. Systematic review of fibroadenoma as a risk factor for breast cancer. *Breast*. 2003;12(5):302-7. [https://doi.org/10.1016/s0960-9776\(03\)00123-1](https://doi.org/10.1016/s0960-9776(03)00123-1)
14. Kabat GC, Jones JG, Olson N, Negassa A, Duggan C, Ginsberg M, et al. A multi-center prospective cohort study of benign breast disease and risk of subsequent breast cancer. *Cancer Causes Control*. 2010;21(6):821-8. <https://doi.org/10.1007/s10552-010-9508-7>
15. Yoshida M, Sekine S, Ogawa R, Yoshida H, Maeshima A, Kanai Y, et al. Frequent MED12 mutations in phyllodes tumours of the breast. *Br J Cancer*. 2015;112:1703-8. <https://doi.org/10.1038/bjc.2015.116>
16. Sawhney N, Garrahan N, Douglas-Jones AG, Williams ED. Epithelial-stromal interactions in tumors. A morphologic study of fibroepithelial tumors of the breast. *Cancer*. 1992;70(8):2115-20. [https://doi.org/10.1002/1097-0142\(19921015\)70:8<2115::aid-cnrcr2820700818>3.0.co;2-k](https://doi.org/10.1002/1097-0142(19921015)70:8<2115::aid-cnrcr2820700818>3.0.co;2-k)
17. Gordon PB, Gagnon FA, Lanzkowsky L. Solid Breast Masses Diagnosed as Fibroadenoma at Fine-Needle Aspiration Biopsy: Acceptable Rates of Growth at Long-term Follow-up. *Radiology* [Internet]. 2003 [accessed on Sept. 15, 2019];229(1):233-8. Available at: <https://www.ncbi.nlm.nih.gov/pubmed/14519878> <https://doi.org/10.1148/radiol.2291010282>
18. Derossi DR, Ito K, Couto Filho JO, Bacchi CE. Avaliação da expressão da proteína bcl-2 no carcinoma de mama: estudo em punção aspirativa por agulha fina; correlação com grau histológico em espécimes cirúrgicos correspondentes. *J Bras Patol Med Lab* [Internet]. 2003 [accessed on Sept. 11, 2019];39(3):229-35. Available at: [http://www.scielo.br/scielo.php?script=sci\\_arttext&pid=S1676-24442003000300010](http://www.scielo.br/scielo.php?script=sci_arttext&pid=S1676-24442003000300010) <https://doi.org/10.1590/S1676-24442003000300010>
19. Darooei M, Khan F, Rehan M, Zubeda S, Jeyashanker E, Annapurna S, et al. Med12 somatic mutations encompassing exon 2 associated with benign breast fibroadenomas and not breast carcinoma in Indian women. *J Cell Biochem* [Internet]. 2018 [accessed on Mar. 3, 2019];120(1):182-91. Available at: <https://doi.org/10.1002/jcb.27293>
20. Stachs A, Stubert J, Reimer T, Hartmann S. Benign Breast Disease in Women. *Dtsch Arztebl Int* [Internet]. 2019 [accessed on Mar. 5, 2019];116(33-34):565-74. Available at: <https://www.ncbi.nlm.nih.gov/pmc/articles/PMC6794703/> <https://doi.org/10.3238%2Faztebl.2019.0565>
21. Roveda Junior D, Piatto S, Oliveira VM, Rinaldi JF, Ferreira CAP, Fleury ECF. Valores preditivos das categorias 3, 4 e 5 do Sistema BI-RADS em lesões mamárias nodulares não-palpáveis avaliadas por mamografia, ultra-sonografia e ressonância magnética. *Radiol Bras* [Internet]. 2007 [accessed on Mar. 3, 2019];40(2):93-8. Available at: [https://www.scielo.br/scielo.php?script=sci\\_arttext&pid=S0100-39842007000200006](https://www.scielo.br/scielo.php?script=sci_arttext&pid=S0100-39842007000200006) <https://doi.org/10.1590/S0100-39842007000200006>
22. Calado SS, Lima MCCA. Estudo morfológico dos fibroadenomas da mama: uma análise comparativa entre grupos etários. *J Bras Patol Med Lab* [Internet]. 2004 [accessed on Sept. 11, 2019];40(6):411-9. Available at: [http://www.scielo.br/scielo.php?pid=S1676-24442004000600009&script=sci\\_abstract&tlng=pt](http://www.scielo.br/scielo.php?pid=S1676-24442004000600009&script=sci_abstract&tlng=pt) <https://doi.org/10.1590/S1676-24442004000600009>
23. Fleury EFC, Rinaldi JF, Piatto S, Fleury JCV, Roveda Junior D. Appearance of breast masses on sonoelastography with special focus on the diagnosis of fibroadenomas. *Eur Radiol* [Internet]. 2009 [accessed on Sept. 11, 2019];19(6):1337-46. Available at: <https://www.ncbi.nlm.nih.gov/pubmed/19159934> <https://doi.org/10.1007/s00330-008-1285-2>



# Forequarter amputation in a patient with locally advanced recurrent breast carcinoma

René Aloisio da Costa Vieira<sup>1,2,3</sup> , Eduardo Areas Toller<sup>4</sup> ,  
Andréa Moreno Morgan<sup>1,5</sup> , Idam de Oliveira-Junior<sup>2,5</sup> 

## ABSTRACT

Forequarter amputation (FQA) involves the removal of the upper limb, clavicle, and scapula and is indicated for the resection of primary or metastatic tumors invading the axillary neurovascular bundle. Reports on breast cancer have associated FQA with the primary resection of a locally advanced tumor, resection of recurrent disease, brachial plexus injury, Stewart-Treves syndrome, or sarcoma secondary to breast cancer irradiation. We described a case of recurrent breast carcinoma with curative-intent surgery. The surgery aimed at locoregional control and improvement in the quality of life. The literature is scarce on the topic, discussing the multiple aspects related to the indication of FQA for breast cancer patients. This report presents the first case described in Latin American literature.

**KEYWORDS:** Disarticulation; Amputation; Breast neoplasms.

## INTRODUCTION

Surgeries that treat tumors of the shoulder girdle are extensive. Forequarter amputation (FQA) involves the removal of the upper limb, clavicle, and scapula and is indicated for the resection of primary or metastatic tumors invading the axillary neurovascular bundle. Although often described in cases of Stewart-Treves syndrome, post-mastectomy sarcomas, and lymphedema, this surgery is rarely reported in carcinomas. Reports on breast cancer have associated FQA with the primary resection of a locally advanced tumor<sup>1</sup>, resection of recurrent disease<sup>2-5</sup>, brachial plexus injury<sup>5</sup>, Stewart-Treves syndrome<sup>6</sup>, or sarcoma secondary to breast cancer irradiation<sup>7,8</sup>. The literature is scarce on the topic, and the surgery aimed at locoregional control and improvement in the quality of life, justifying this publication.

## CASE REPORT

Female, 73 years old, clinical stage T4bN3M0, associated with extensive and limiting lymphedema of the right upper limb (Figure 1A).

Although hypertension was her only comorbidity, the patient was clinically classified as grade 2 in the Eastern Cooperative Oncology Group (ECOG) Performance Status. The biopsy revealed a triple-negative invasive ductal carcinoma of histological grade 3. Initially, the patient underwent two cycles of neoadjuvant chemotherapy with paclitaxel, not responding to therapy and developing febrile neutropenia. Chemotherapy was suspended due to the worsening of her general condition (ECOG grade 3), asthenia, and inappetence. In this context, the treatment chosen was surgery, and the patient was submitted to a right-sided Halsted mastectomy, considered R1 (minimal microscopic disease) because of the disease located along the brachial plexus (Figure 1). Adjuvant radiotherapy was considered for local control, but the presence of surgical wound dehiscence prevented this treatment. Two months later, she showed visible macroscopic recurrence next to the skin of the axillary fossa, leading to the performance of an R1 resection of the region affected by the neoplasm, adjacent to the dehiscence area, with external oblique myocutaneous rotation flap to close the surgical wound

<sup>1</sup>Graduate Program in Oncology, Hospital do Câncer de Barretos – Barretos (SP), Brazil.

<sup>2</sup>Graduate Program in Gynecology, Obstetrics, and Mastology, School of Medicine of Botucatu – Botucatu (SP), Brazil.

<sup>3</sup>Department of Surgery, Mastology Division, Hospital do Câncer de Muriaé, Fundação Cristiano Varella – Muriaé (MG), Brazil.

<sup>4</sup>Department of Orthopedics, Hospital do Câncer de Barretos – Barretos (SP), Brazil.

<sup>5</sup>Department of Mastology and Breast Reconstruction, Hospital do Câncer de Barretos – Barretos (SP), Brazil.

\*Corresponding author: posgrad@hcancerbarretos.com.br

Conflict of interests: nothing to declare.

Received on: 07/29/2019. Accepted on: 12/25/2019

and provide conditions for adjuvant radiotherapy. She presented new local dehiscence and, in the healing stage, new macroscopic local recurrence (Figures 1 and 2).

Thus, due to the impossibility of administering adjuvant radiotherapy and the early recurrence, FQA was chosen for local control and potential improvement in her quality of life, since the upper limb was no longer functional. FQA was considered R0 (complete resection; Figure 2), and the surgical progress was satisfactory, allowing the start of adjuvant radiotherapy. The patient was questioned about her general quality of life (scores from 1–terrible to 7–great) in the preoperative period, as well as one and three months after surgery. She reported a score of 3 in the preoperative period and 5 in the first and third months. Four months after surgery, she was asymptomatic but showed weight loss of 18 kg, and developed local recurrence metastasis and lung metastasis, being referred to exclusively palliative treatment (Figure 3). Seven months after the FQA, the patient died of pulmonary metastatic disease. FQA has improved her quality of life.

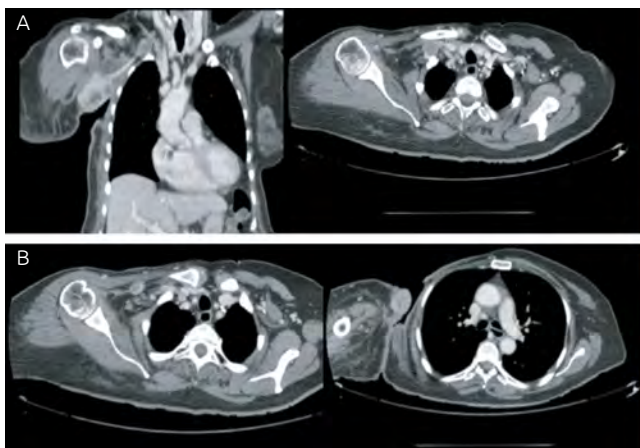

**Figure 1.** Chest computed tomography (A) pre-treatment; (B) after breast lesion resection with minimal residual extrathoracic disease.



**Figure 2.** Forequarter amputation.

## DISCUSSION

In patients submitted to axillary treatment, recurrence is a rare phenomenon, and, even with surgical treatment, the R1 resection<sup>9</sup> is not often complete. These patients require adjuvant therapies, such as chemotherapy and radiotherapy<sup>9,10</sup>, for long-term control of the disease. In some individuals, FQA may be necessary for locoregional control<sup>2,4</sup>.

FQA is often performed in cases of tumor of the shoulder girdle<sup>11</sup>. This procedure is usually carried out with curative or palliative intent, allowing locoregional control of the disease and improving the quality of life. Reports on breast cancer have associated FQA with the primary resection of a locally advanced tumor<sup>1</sup>, resection of recurrent disease<sup>2-5</sup>, brachial plexus injury<sup>5</sup>, Stewart-Treves syndrome<sup>6</sup>, or sarcoma secondary to breast cancer irradiation<sup>7,8</sup>. In series of this type of surgery, the association with breast cancer represents, on average, 12.5% of the causes<sup>11</sup>, an incidence that increases (37.5%) when considering the presence of metastatic disease<sup>12</sup>. Recurrence is its main indication<sup>2,3,5</sup> with palliative intent<sup>3,5</sup>. The literature is scarce on the topic, and we found no cases described in Latin American literature.

Despite the radical nature of the surgery, it allows locoregional control, improvement in symptoms and quality of life, and prolongation of the disease-free interval, which justify its performance in selected cases with curative or palliative intent<sup>2,3,5</sup>. Similarly, this procedure should be considered for patients with brachial plexus injury, neurovascular involvement, and upper limb dysfunction<sup>5</sup>.

In the present case, the initial surgery showed the presence of disease along the brachial plexus, and, at first, surgery was not indicated, as radiotherapy was contemplated for local control. Unfortunately, the patient progressed to local dehiscence. Initially, the abdominal oblique flap was considered for primary closure. The new dehiscence, the impossibility of administering other adjuvant therapy, and the local progression of the disease led to the performance of a curative-intent FQA, but the patient

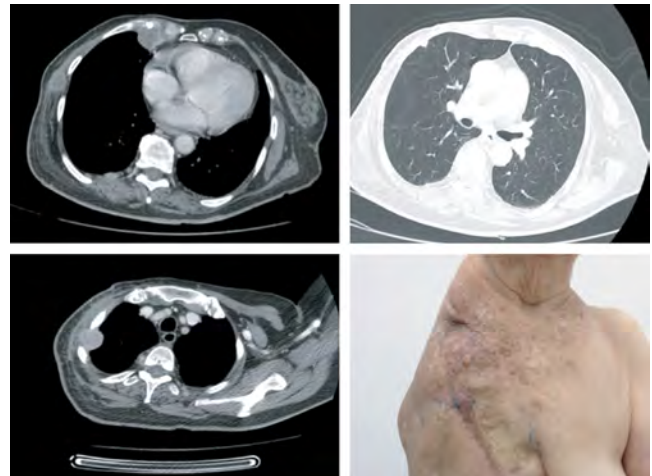

**Figure 3.** Local and lung recurrence.

died seven months later due to the progression of the lung disease. Usually, FQA is indicated for patients with distant recurrence and prolonged disease-free interval<sup>3</sup>; however, the complications and the clinical condition of the patient led to surgical treatment being the only option for local control.

One of the main points to consider with respect to FQA is the closure of the resected area, which can be done with skin grafts, reuse of part of the skin of the limb, and myocutaneous rotation flaps<sup>2,3,5</sup>. The complication rate is relatively low and usually associated with skin necrosis, local dehiscence, and pleural effusion<sup>2-5</sup>. In this case, the local flaps used originated from the healthy skin of the shoulder, careful of the small area of local dehiscence, controlled with resuture and dressings.

FQA has not been evaluated yet regarding the breast cancer tumor subtype. Triple-negative tumors show worse behavior, but studies involving FQA did not assess this fact. Survival is better in curative-intent treatments, with a mean of 23 months, decreasing to 13 months in palliative ones<sup>3</sup>, which fully justifies the surgery in selected cases. In this patient with a triple-negative tumor, FQA was considered curative because of the R0 resection; however, her clinical conditions were poor. The lack of adjuvant

therapy and the aggressive nature of the tumor influenced the local recurrence and the short disease-free interval, resulting in limited survival.

## CONCLUSION

FQA is an exceptional procedure for patients with recurrent breast carcinoma. It is associated with low surgical morbidity and mortality and should be considered, even if with palliative intent, for prolonging the disease-free interval and improving symptoms of specific diseases and the quality of life.

## AUTHORS' CONTRIBUTION

R.A.C.V.: study concept, data curation, formal analysis, methodology, project management.

E.A.T.: data curation, research, methodology.

A.M.M.: methodology.

I.O.-Jr.: formal analysis, methodology.

All authors contributed to the writing of the original manuscript, in addition to reviewing and editing the article.

## REFERENCES

1. Ayvaz M, Yilgor C, Mermerkaya UM, Konan A, Sonmez E, Acaroglu RE. Simultaneous forequarter amputation and radical mastectomy for metastatic breast carcinoma in a male patient: a case report. *J Korean Surg Soc.* 2011;81(Suppl. 1):S6-S11. <https://dx.doi.org/10.4174%2Fjkss.2011.81.Suppl1.S6>
2. Goodman MD, McIntyre B, Shaughnessy EA, Lowy AM, Ahmad SA. Forequarter amputation for recurrent breast cancer: a case report and review of the literature. *J Surg Oncol.* 2005;92(2):134-41. <https://doi.org/10.1002/jso.20337>
3. Pundi KN, AlJamal YN, Ruparel RK, Farley DR. Forequarter amputation for recurrent breast cancer. *Int J Surg Case Rep.* 2015;11:24-8. <https://dx.doi.org/10.1016%2Fijscr.2015.04.018>
4. Tsai CH, Tzeng HE, Juang WK, Chu PG, Fann P, Fong YC, et al. Curative use of forequarter amputation for recurrent breast cancer over an axillary area: a case report and literature review. *World J Surg Oncol.* 2014;12:346. <https://doi.org/10.1186/1477-7819-12-346>
5. Behnke NK, Crosby SN, Stutz CM, Holt GE. Periscapular amputation as treatment for brachial plexopathy secondary to recurrent breast carcinoma: a case series and review of the literature. *Eur J Surg Oncol.* 2013;39(12):1325-31. <https://doi.org/10.1016/j.ejso.2013.10.005>
6. Roy P, Clark MA, Thomas JM. Stewart-Treves syndrome--treatment and outcome in six patients from a single centre. *Eur J Surg Oncol.* 2004;30(9):982-6. <https://doi.org/10.1016/j.ejso.2004.07.027>
7. Borman H, Safak T, Ertoy D. Fibrosarcoma following radiotherapy for breast carcinoma: a case report and review of the literature. *Ann Plast Surg.* 1998;41(2):201-4. <https://doi.org/10.1097/0000637-199808000-00015>
8. Doherty MA, Rodger A, Langlands AO. Sarcoma of bone following therapeutic irradiation for breast carcinoma. *Int J Radiat Oncol Biol Phys.* 1986;12(1):103-6. [https://doi.org/10.1016/0360-3016\(86\)90422-0](https://doi.org/10.1016/0360-3016(86)90422-0)
9. de Boer R, Hillen HF, Roumen RM, Rutten HJ, van der Sangen MJ, Voogd AC. Detection, treatment and outcome of axillary recurrence after axillary clearance for invasive breast cancer. *Br J Surg.* 2001;88(1):118-22. <https://doi.org/10.1046/j.1365-2168.2001.01637.x>
10. Newman LA, Hunt KK, Buchholz T, Kuerer HM, Vlastos G, Mirza N, et al. Presentation, management and outcome of axillary recurrence from breast cancer. *Am J Surg.* 2000;180(4):252-6. [https://doi.org/10.1016/s0002-9610\(00\)00456-6](https://doi.org/10.1016/s0002-9610(00)00456-6)
11. Rickelt J, Hoekstra H, van Coevorden F, de Vreeze R, Verhoef C, van Geel AN. Forequarter amputation for malignancy. *Br J Surg.* 2009;96(7):792-8. <https://doi.org/10.1002/bjs.6555>
12. Wittig JC, Bickels J, Kollender Y, Kellar-Graney KL, Meller I, Malawer MM. Palliative forequarter amputation for metastatic carcinoma to the shoulder girdle region: indications, preoperative evaluation, surgical technique, and results. *J Surg Oncol.* 2001;77(2):105-13; discussion 114. <https://doi.org/10.1002/jso.1079>





# Breast cancer after chest irradiation for lymphoma: case report

Danilo Rafael da Silva Fontinele<sup>1\*</sup> , Sabas Carlos Vieira<sup>2</sup> 

## ABSTRACT

Breast cancer is one of the most common diseases among women worldwide. One of the risk factors for the development of this neoplasia is previous radiotherapy on the chest wall. Breast cancer, in turn, is the main long-term concern among women treated for lymphoma with radiation on the chest wall. Thus, we present a case of breast cancer that appeared 18 years after chest radiation for the treatment of lymphoma.

**KEYWORDS:** breast neoplasms; lymphoma; radiotherapy.

## INTRODUCTION

Breast cancer is one of the most common diseases and an important public health challenge among women worldwide. Some of the risk factors for the development of this neoplasm are, family history, reproductive factors, lifestyle, and previous radiation therapy on the chest wall, especially in young patients<sup>1,2</sup>.

On the other hand, radiotherapy is important in the treatment of lymphomas. Although the risk of recurrent lymphoma decreases in long-term survivors, the incidence of radiation-induced cancers increases with time. Breast cancer, in turn, is the main long-term concern among women who have been previously treated for lymphoma with radiation on the chest wall<sup>3</sup>.

Thus, we report a case of breast cancer that arose after chest radiation for the treatment of lymphoma.

## CASE REPORT

A 43-year-old patient was diagnosed with non-special invasive carcinoma in the left breast during a routine examination by means of imaging tests (mammography, ultrasound and breast resonance). On the resonance, the tumor measured 0.7 cm. She had a history of chest irradiation for lymphoma 18 years prior (Figure 1), with no evidence of disease activity when the breast cancer was diagnosed. We did not have access to the histological type of the lymphoma. In her family history, she has two sisters that had BRCA1 mutations; one developed breast cancer, and the other

underwent prophylactic oophorectomy. The BRCA mutation test was negative for the patient. She underwent a bilateral mastectomy with preservation of the skin and the nipple-areolar complex (Figure 2). A histological examination of the surgical specimens showed no tumor on the right breast, and on the left breast, the following were identified: a non-special invasive carcinoma of 0.7 cm in the largest diameter, G2, negative sentinel lymph node, Luminal A (90% estrogen receptors, progesterone receptors 90%, ki-67 10%, human epidermal growth factor type 2 receptor 2+,



Arrow: catheter scar for lymphoma treatment 18 years earlier; circle: fibroadenoma in the right breast.

**Figure 1.** Scar from the catheter implantation site for chemotherapy to treat lymphoma.

<sup>1</sup>Universidade Estadual do Piauí – Teresina (PI), Brazil.

<sup>2</sup>Clínica Oncocentro – Teresina (PI), Brazil.

\*Corresponding author: drsilvafontinele@gmail.com

Conflict of interests: nothing to declare.

Received on: 04/28/2020. Accepted on: 06/08/2020.

hybridization *in situ* negative fluorescent). The oncotype demonstrated a Recurrence Score of 9. Four months after breast surgery, she presented clinical worsening of deep endometriosis. A hysterectomy with a bilateral adnexectomy was performed using videolaparoscopy. In the 54-month follow-up (Figure 3), she did not have a recurrence of the disease and was using exemestane and zoledronic acid, and had a good quality of life. The study was approved by the Research Ethics Committee of the Universidade Federal do Piauí, number 2,948,415. Additionally, the patient signed an informed consent form.

## DISCUSSION

Radiation used to treat lymphoma has the ability to cause molecular damage to human body tissues, including cell death and functional changes. The effects can be tissue reactions or stochastic effects, the highest ones indicate a higher dose of radiation to be used, and they are cumulative. Therefore, the consequences are late and may lead to the development of malignant neoplasms, especially in patients exposed to radiation before the age of ten<sup>4</sup>.



**Figure 2.** Result of a bilateral mastectomy with skin preservation and nipple-areolar complex, with inclusion of bilateral submuscular prosthesis and an investigation of the left sentinel lymph node.

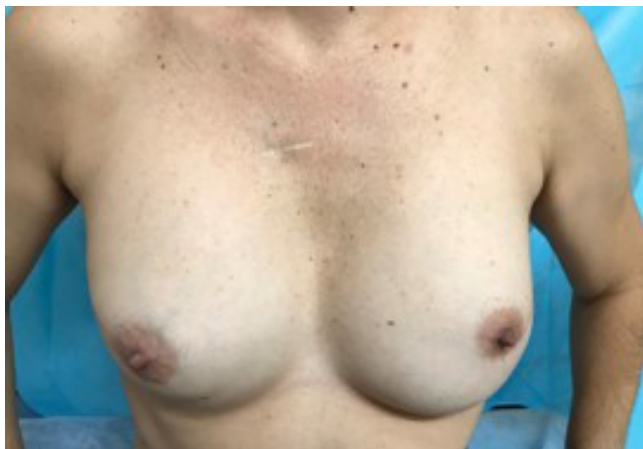

**Figure 3.** 54 months after surgery.

The risk of developing new cancer after radiotherapy depends on the dose and location of the treatment, and there may be an additional risk of breast, thyroid, leukemia and lung cancer<sup>4-6</sup>. The highest risk is found in the subgroup of patients who received treatment as young children, with a wide description of cases between 10 and 14 years old. In patients older than 35 years old who underwent treatment, there was no difference in changes in relative risks<sup>5</sup>. In the present case, the tumor appeared 18 years after the lymphoma treatment.

Some authors recommend an evaluation of the dose-volume used in radiotherapy as a determining factor for the risk of developing a second primary cancer. However, a meta-analysis published in 2018<sup>7</sup> failed to measure and/or associate dose-volume with variations in additional risk due to incompatibility and heterogeneity in the description of the data collected in the various studies.

In a study of the follow-up of patients after treatment for Hodgkin's lymphoma<sup>8</sup>, in a single center, the risk of developing the second cancer was 80.8%. Breast cancer was the second most frequent, second only to lung cancer. In other studies, breast cancer was the most prevalent after chest wall radiotherapy for the treatment of lymphoma<sup>9</sup>.

A study published in 2005 crossed data from patients undergoing treatment for lymphoma who used radiotherapy with the use of alkylating agents<sup>10</sup>. The use of alkylating agents decreased the chance of developing a second neoplasm, whereas higher doses of radiotherapy (> 40Gy) without the use of alkylating agents represented a greater risk of developing the disease. In the case presented here, we did not have access to the chemotherapy regimen that the patient underwent for the treatment of lymphoma.

Compared to sporadic breast cancer, breast cancer after radiotherapy was more likely to be bilateral (6%–34%), to have negative hormone receptors (27%–49%), and to be high-grade (35%). Disease-free survival has been shown to be similar to groups of patients with primary breast cancer of the same immunohistochemical profile, although comorbidities are greater in the groups of patients who received previous radiation therapy, probably due to the effects of the initial treatment<sup>11</sup>. Due to the risk of bilateral breast cancer, the recommended treatment is a bilateral mastectomy, as performed in the case analyzed in this study.

Identifying groups at risk of developing second primary cancer is crucial for strategies to be adopted, to facilitate screening and to minimize consequences. Therefore, women who received radiation in the thoracic region due to a malignant disease in childhood are recommended to keep screening for breast cancer with an annual mammography, starting at the age of 25, or eight years after the initial radiotherapy, whichever comes first<sup>12,13</sup>.

A systematic review published in 2010 found that, although the outcome of patients diagnosed with breast cancer after childhood radiotherapy is similar to that of patients diagnosed with breast cancer without prior radiation therapy, studies suggest specific screening strategies, as the risk determined

by radiotherapy appears to remain stable over the years and does not reach a plateau, which keeps patients in an increasingly high risk group<sup>14</sup>.

In a systematic review, published in 2018, it is suggested that mammography and MRI screenings be performed starting at the age of 25 or after eight years of initial radiotherapy (whichever comes first) in women who received > 20 Gy in the chest wall before turning 30 years old<sup>10,11</sup>. Other authors already recommend the practice for groups that received > 10 Gy in the chest wall. Genetic tests can be considered in specific cases and are able to help identify the highest risk cases<sup>11</sup>.

## CONCLUSION

Breast cancer is the main malignancy to develop after radiotherapy to treat lymphoma. Due to the cumulative factor of ionizing radiation, the risk increases after several years of treatment,

especially in cases of patients who received high doses of radiation therapy. However, the data are still very heterogeneous and may be influenced by variables related to other treatment modalities. Currently, we must stratify the groups at greatest risk. Nevertheless, a model that combines the increased risk of radiation therapy with predisposing genetic factors should offer a guide towards more successful and targeted screening strategies and approaches in the future.

## AUTHORS' CONTRIBUTION

D.F.: Design, data curation, formal analysis, research, methodology, project management, resources, software, validation, visualization, writing – reviewing and editing.

S.V.: Design, data curation, formal analysis, acquisition of funding, research, methodology, project management, supervision, validation, visualization, writing – reviewing and editing.

## REFERENCES

1. Sun YS, Zhao Z, Yang ZN, Xu F, Lu HJ, Zhu ZY, et al. Risk Factors and Preventions of Breast Cancer. *Int J Biol Sci.* 2017;13(11):1387-97. <https://dx.doi.org/10.7150%2Fijbs.21635>
2. Rojas K, Stuckey A. Breast Cancer Epidemiology and Risk Factors. *Clin Obstet Gynecol.* 2016;59(4):651-72. <https://doi.org/10.1097/grf.0000000000000239>
3. Wahner-Roedler DL, Petersen IA. Risk of Breast Cancer and Breast Cancer Characteristics in Women After Treatment for Hodgkin Lymphoma. *Drugs Today (Barc).* 2004;40(10):865-79. <https://doi.org/10.1358/dot.2004.40.10.863746>
4. Okumo E. Efeitos biológicos das radiações ionizantes: acidente radiológico de Goiânia. *Estud Av.* 2013;27(77):185-200. <https://doi.org/10.1590/S0103-40142013000100014>
5. Willett W, Tamimi R, Hankinson S, Hunter D, Colditz G. Nongenetic factors in the causation of breast cancer. In: Harris JR, Lippman ME, Morrow M, Osborne CK, editores. *Diseases of the breast.* 4ª ed. Philadelphia: Lippincott/Wolters Kluwer Health; 2009. p. 248-275.
6. Hancock S, Tucker MA, Hoppe RT. Breast cancer after treatment of Hodgkin's disease. *J Natl Cancer Inst.* 1993;85(1):25-31. <https://doi.org/10.1093/jnci/85.1.25>
7. Journy N, Mansouri I, Allodji RS, Demoor-Goldschmidt C, Ghazi D, Haddy N, et al. Volume Effects of radiotherapy on the risk of second primary cancers: A systematic review of clinical and epidemiological studies. *Radiother Oncol.* 2019;131:150-9. <https://doi.org/10.1016/j.radonc.2018.09.017>
8. Petrakova K, Vyskocil J, Grell P, Majek O, Soumarova R, Novak J, et al. Second cancers in Hodgkin's lymphoma long-term survivals: A 60-year single institutional experience with real-life cohort of 871 patients. *Int J Clin Pract.* 2018;72(9):e13285. <https://doi.org/10.1111/ijcp.13235>
9. Zedníková I, Safránek J, Hlaváčková M, Hes O, Svoboda T. Sarcoma of the Chest Wall After Radiotherapy for Breast Carcinoma - A Case Report. *Rozhl Chir.* 2014;93(7):396-400.
10. Travis LB, Hill D, Dores GM, Gospodarowicz M, van Leeuwen FE, Holawaty E, et al. Cumulative Absolute Breast Cancer Risk for Young Women Treated for Hodgkin Lymphoma. *J Natl Cancer Inst.* 2005;97(19):1428-37. <https://doi.org/10.1093/jnci/dji290>
11. Derman YE. Clinical Practice Recommendations based on an updated review of breast cancer risk among women treated for childhood cancer. *J Pediatr Oncol Nurs.* 2018;35(1):65-78. <https://doi.org/10.1177/1043454217727515>
12. Daly MB, Pilarski R, Berry M, Buys SS, Farmer M, Friedman S, et al. National Comprehensive Cancer Network (NCCN): Genetic/Familial High-Risk Assessment: Breast and Ovarian, Version 2.2017. 2017;15(1):9-20. <https://doi.org/10.6004/jnccn.2017.0003>
13. Oeffinger KC, Ford JS, Moskowitz CS, Diller LR, Hudson MM, Chou JF, et al. Breast Cancer Surveillance practices among women previously treated with chest radiation for a childhood cancer. *JAMA.* 2009;301(4):404-14. <https://doi.org/10.1001/jama.2008.1039>
14. Henderson TO, Amsterdam A, Bhatia S, Hudson MM, Meadows AT, Neglia JP, et al. Systematic review: surveillance for breast cancer in women treated with chest radiation for childhood, adolescent, or young adult cancer. *Ann Intern Med.* 2010;152(7):444-55. <https://doi.org/10.7326/0003-4819-152-7-201004060-00009>



# Vitiligo as a Köebner phenomenon after oncoplastic breast surgery

Régis Resende Paulinelli<sup>1,2\*</sup>, Leonardo Ribeiro Soares<sup>2</sup>, Carla Paulinelli Seba<sup>3</sup>

## ABSTRACT

The Köebner phenomenon is characterized by the appearance of several types of dermatological lesions after traumatic stimulation. The triggering of this phenomenon after breast surgery is uncommon and usually associated with psoriatic lesions. The aim of this study was to describe two cases of vitiligo as the initial manifestation of Köebner phenomenon after breast oncoplastic surgery. Case 1: female, 41 years old, no history of dermatological pathologies, presenting with tubular carcinoma in the right breast. Quadrantectomy and sentinel lymph node biopsy were performed, followed by reconstruction with mammoplasty. Later, the patient started on tamoxifen and underwent radiotherapy, without complications. Thirty days after treatment, the patient presented progressive depigmentation of the areola-papillary complex. Topical treatment was started with dermatological ointment tacrolimus monohydrate and, after one year, the condition was completely resolved. Case 2: 52-year-old woman with previous history of vitiligo on the face, with complete clinical response after dermatological treatment. She was diagnosed with ductal carcinoma *in situ* on the left breast and underwent quadrantectomy, by means of mammoplasty using the round block technique. Afterwards, she underwent radiotherapy and started tamoxifen. Four years after the surgery, she developed dyschromia in the ipsilateral periareolar region and was diagnosed with vitiligo. Local dermopigmentation was offered, but the patient opted for an expectant conduct and clinical follow-up. To our knowledge, this is the first description of Köebner phenomenon after breast oncoplastic surgery. In these cases, the therapeutic approach must be multidisciplinary and count on the assessment of multiple clinical and individual parameters.

**KEYWORDS:** breast neoplasms; vitiligo; conservative treatment; breast cancer; oncoplasty.

## INTRODUCTION

The first description of the Köebner phenomenon, in 1877, involved psoriatic lesions secondary to trauma in non-affected skin portions of patients with psoriasis<sup>1</sup>. The concept of the Köebner phenomenon has been expanded to currently encompass the appearance of several types of skin lesions after local traumatic stimulus, even in individuals with no previously diagnosed dermatological diseases<sup>2</sup>. Although it can affect up to 25% of psoriasis patients submitted to skin traumatic stimulation, the etiology and pathological mechanisms underlying the phenomenon have not been completely clarified<sup>2</sup>.

In the framework of dermatological lesions that can be triggered by this phenomenon, vitiligo lesions also stand out. Vitiligo is characterized as an acquired disorder that

progresses with chronic changes in the pigmentation of the skin and *fanera*, due to the functional loss of melanocytes<sup>3</sup>. The etiology of vitiligo is still not completely elucidated, although there are autoimmune and genetic components capable of activating the disease, as well as epigenetic features capable of triggering the disease by means of environmental factors<sup>4</sup>.

Surgical trauma is an environmental factor that can compete with an area of depigmentation in a region of previously normal skin<sup>5</sup>. The development of vitiligo after abrasions, incisions or surgical wounds is known as an isomorphic phenomenon and can happen in patients with a previous diagnosis of the disease. It can, however, also affect patients not diagnosed with vitiligo, at a lower incidence<sup>6</sup>.

<sup>1</sup>Center for Medicine Amin Daher – Goiânia (GO), Brazil.

<sup>2</sup>Universidade Federal de Goiás – Goiânia (GO), Brazil.

<sup>3</sup>Universidade Católica de Brasília – Brasília (DF), Brazil.

\*Corresponding author: rrpaulinelli@gmail.com

Conflict of interest: nothing to declare.

Received on: 04/09/2020. Accepted on: 05/15/2020.

Although the Köebner phenomenon is relatively common in the surgical field, reports of its occurrence after breast surgery are scarce in the literature. In addition, it is usually associated with the occurrence of psoriatic lesions, which makes its presentation in the form of vitiligo even more unusual<sup>4,7</sup>. Thus, the objective of this study was to describe two cases of vitiligo as an initial manifestation of the Köebner phenomenon after breast oncological surgery.

## CASE REPORTS

### Case 1

A 52-year-old female, who had been using hormone therapy for three years, was admitted to the service due to altered exams. History of vitiligo on the face, with complete clinical response after dermatological treatment. Upon physical examination, no palpable change was felt in the breasts and armpits. Mammography showed amorphous microcalcifications grouped in the upper lateral quadrant of the left breast. Left breast mastectomy was performed and the anatomopathological examination showed two foci of ductal carcinoma *in situ*, measuring 0.3 and 0.4 cm, respectively.

Immunohistochemistry of the lesion revealed expression of estrogen (2+/4+) and progesterone (1+/4+), Ki67 receptors in 5% of neoplastic cells and absence of HER2 oncoprotein. Left quadrantectomy was performed by means of mammoplasty using the round block technique and, following the location of the metal clip inserted during the mastectomy, no residual neoplasia was found (pT1c cN0 M0, Ec 0). The patient had good postoperative recovery and satisfactory breast symmetry. Then, she underwent adjuvant radiotherapy on the left breast and started using Tamoxifen, not showing any serious adverse events. Four years after surgery, she developed dyschromia in the left breast's periareolar region, which was diagnosed as vitiligo in a dermatological consultation. The patient was offered the possibility of local dermopigmentation, but opted for an expectant conduct and clinical follow-up (Figure 1).

### Case 2

Female 41-year-old patient with no history of breast surgery or previous dermatological diseases, reported having a nodule in her right breast for two years in progressive growth. Upon physical examination, no palpable change was felt in the breasts and armpits. Breast ultrasound showed simple bilateral cysts and a hypoechoic, lobulated nodule measuring 0.7 cm in the lower medial quadrant of the right breast. Mammography showed punctiform microcalcifications grouped in the same topography of the right breast, which seemed stable in relation to previous mammographic exams. The lesion was removed and identified as tubular carcinoma grade I, measuring 1.1 cm and touching the surgical margins. The patient underwent quadrantectomy and sentinel lymph node biopsy on the right breast, with immediate reconstruction, using J mammoplasty. The anatomopathological study showed absence of residual neoplasia and free axillary lymph nodes (pT1c pN0sn M0, Ec Ia). Immunohistochemistry of the lesion revealed expression of estrogen (3+/4+) and progesterone (1+/4+), negative HER2 and Ki67 receptors in 5% of neoplastic cells. The patient had a good postoperative recovery and satisfactory breast symmetry. Afterwards, she started adjuvant endocrine therapy with Tamoxifen and adjuvant radiotherapy, which was uneventful. Thirty days after radiotherapy, the patient presented with progressive depigmentation of the areola-papillary complex on the right (Figure 2). The patient was offered the possibility of local dermopigmentation, but opted for topical treatment with tacrolimus monohydrate dermatological ointment 0.1% twice a day. After six months of treatment, she had a partial improvement of hypochromia in the right breast (Figure 3).

## DISCUSSION

The Köebner phenomenon after breast surgery is uncommon and generally associated with the occurrence of psoriatic lesions<sup>2,7</sup>; however, there are descriptions of the phenomenon after radical mastectomy<sup>8</sup>, bilateral prophylactic

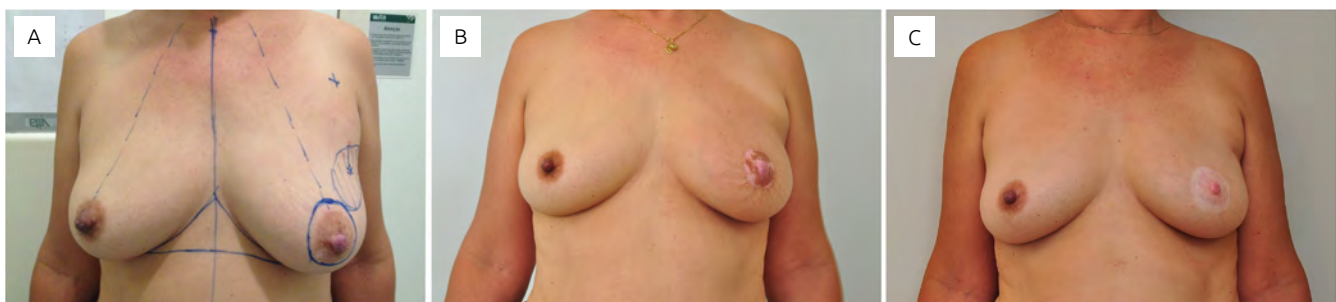

**Figure 1.** Case 1: (A) Preoperative marking. (B) Köebner phenomenon in the postoperative period of oncoplastic surgery, six months after radiotherapy. (C) Late residual appearance two years after surgery.

mastectomy and reconstruction with prostheses<sup>7</sup>, and after skin-sparing mastectomy with immediate reconstruction, using prosthesis and latissimus dorsi muscle flap<sup>9</sup>. To our knowledge, the cases reported in the current study are the first descriptions of this phenomenon after breast oncoplastic surgery. In this context, the early recognition of the condition by the professional surgeon can lead to the adequate therapeutic management and, possibly, to more satisfactory clinical results.

The pathophysiology underlying the Koebner phenomenon remains inconclusive, despite the frequent observation of epidermal cell damage associated with the inflammatory dermal reaction<sup>2,7</sup>, but experimental studies involving its induction have shown divergent results when it comes to the clinical manifestations of the lesions<sup>2</sup>. Thus, physical, biochemical, and immunological factors can also be associated with the occurrence of the Koebner phenomenon and contribute to the diversity of clinical presentations seen in the literature<sup>2,4,10</sup>.

Radiotherapy is also associated with several clinical manifestations, as well as early and late skin toxicity<sup>11,12</sup>, including the occurrence of the phenomenon in the absence of previous surgical procedures<sup>13</sup>. However, the occurrence of vitiligo after radiotherapy is uncommon and, to our knowledge, there are less than 20 cases reported worldwide<sup>12,14</sup>. The pathophysiology would probably involve the susceptibility of certain melanocytes to apoptosis mediated by oxidative stress, and to free radicals generated by irradiation<sup>11-14</sup>, although most cases report lesions in the entire portion affected by radiotherapy<sup>11,14</sup>, and not only in scar topography. In addition, the patients described in this series had good tolerance to radiotherapy and minimal inflammatory effect on the breasts, which reduced the possibility of skin lesions secondary to radiotherapy.

As for skin treatment, the severity, topography and clinical presentation of the lesions must be considered. When lesions present in the form of vitiligo, topical treatment with corticosteroids or biological therapies, treatments involving some types of light (for example, narrowband UV-B) and systemic medications, along with various skin pigmentation

techniques, can be performed<sup>15</sup>. However, in selected cases, expectant conduct<sup>16</sup> or the combination of two or more therapies can be adopted<sup>17</sup>. In one of the cases described, clinical response with tacrolimus monohydrate dermatological ointment was satisfactory.

## CONCLUSION

To our knowledge, this is the first description of Koebner phenomenon after breast oncoplastic surgery. In these cases, the therapeutic approach must be multidisciplinary and in accordance with the evaluation of multiple clinical and individual parameters.

## AUTHORS' CONTRIBUTION

R. P.: Conceptualization, funding, research, methodology, management, supervision, validation, visualization, writing of the project – review and editing.

L. R.: Conceptualization, funding acquisition, research, methodology, project management, validation, visualization, writing – review and editing.

C. S.: Conceptualization, funding, research, methodology, management, validation, visualization, writing – project review and editing.



**Figure 3.** Right breast (A) before and (B) after topical treatment with tacrolimus monohydrate dermatological ointment 0.1%, twice a day. Partial improvement in hypochromia after six months of treatment. (C) There was complete improvement after one year of treatment.

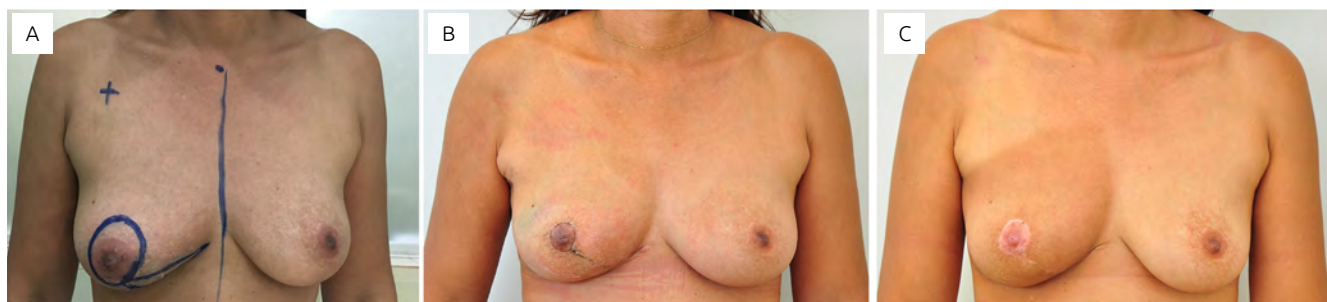





**Figure 2.** Case 2: (A) Preoperative marking. (B) Immediate postoperative period without dermatological changes two months later. (C) Koebner phenomenon in the late postoperative period of oncoplastic surgery, six months after radiotherapy.

## REFERENCES

1. Köbner H. Zur Aetiologie Psoriasis. *Vjschr Dermatol.* 1876;3:559.
2. Weiss G, Shemer A, Trau H. The Koebner phenomenon: review of the literature. *J Eur Acad Dermatol Venereol.* 2002;16(3):241-8. <https://doi.org/10.1046/j.1473-2165.2002.00406.x>
3. Ghafourian E, Ghafourian S, Sadeghifard N, Mohebi R, Shokoohini Y, Nezamoleslami S, et al. Vitiligo: Symptoms, Pathogenesis and Treatment. *Int J Immunopathol Pharmacol.* 2014;27(4):485-9. <https://doi.org/10.1177/039463201402700403>
4. Ji YZ, Liu SR. Koebner phenomenon leading to the formation of new psoriatic lesions: evidences and mechanisms. *Biosci Rep.* 2019;39(12):BSR20193266. <https://doi.org/10.1042/BSR20193266>
5. Ganguly AK, Laghimsetty S, Bhagyalakshmi N. Koebner Phenomenon Triggered by External Dacryocystorhinostomy Scar in a Patient With Psoriasis: A Case Report and Literature Review. *Ophthalmic Plast Reconstr Surg.* 2018;34(2):e52-e53. <https://doi.org/10.1097/IOP.0000000000001016>
6. Mulekar SV, Asaad M, Ghwish B, Al Issa A, Al Eisa A. Koebner Phenomenon in Vitiligo: Not Always an Indication of Surgical Failure. *Arch Dermatol.* 2007;143(6):799-816. <https://doi.org/10.1001/archderm.143.6.801>
7. Alolabi N, White CP, Cin AD. The Koebner phenomenon and breast reconstruction: Psoriasis eruption along the surgical incision. *Can J Plast Surg.* 2011;19(4):143-4. <https://doi.org/10.1177/229255031101900411>
8. Bernstein EF, Kantor GR. Treatment-resistant psoriasis due to a mastectomy sleeve: an extensive Koebner response. *Cutis.* 1992;50(1):65-7.
9. Behranwala KA, Gui GPH. The Koebner phenomenon in a myocutaneous flap following immediate breast reconstruction. *Br J Plast Surg.* 2002;55:267-8. <https://doi.org/10.1054/bjps.2002.3807>
10. Ji YZ, Liu SR. Koebner phenomenon leading to the formation of new psoriatic lesions: evidences and mechanisms. *Biosci Rep.* 2019;39(12). <https://doi.org/10.1042/BSR20193266>
11. Wu CC, Wang S, An JJ, Smith DR, Chin C, Jadeja PH, et al. Koebner phenomenon: Consideration when choosing fractionation for breast irradiation. *Adv Radiat Oncol.* 2018;3(2):108-110. <https://doi.org/10.1016/j.adro.2017.11.004>
12. Dalmasso C, Tournier É, de Lafontan B, Modesto A, Dalenc F, Chantalat É, et al. Uncommon dermatologic disorders triggered by radiation therapy of breast cancer: A case-series. *Cancer Radiother.* 2017;21(3):216-221. <https://doi.org/10.1016/j.canrad.2016.11.004>
13. Charalambous H, Bloomfield D. Psoriasis and radiotherapy: exacerbation of psoriasis following radiotherapy for carcinoma of the breast (the Koebner phenomenon). *Clin Oncol (R Coll Radiol).* 2000;12(3):192-3. <https://doi.org/10.1053/clon.2000.9149>
14. Weitzen RI, Pfeffer R, Mandel M. Benign lesions in cancer patients: Case 3. Vitiligo after radiotherapy for breast cancer in a woman with depigmentation disorder. *J Clin Oncol.* 2005;23(3):644. <https://doi.org/10.1200/JCO.2005.03.078>
15. Whitton ME, Pinart M, Batchelor J, Leonardi-Bee J, González U, Jiyad Z, et al. Interventions for vitiligo. *Cochrane Database Syst Rev.* 2015;(2):CD003263. <https://doi.org/10.1002/14651858.CD003263.pub5>
16. Dowlen H, Owers K. Koebner phenomenon following steroid injection for trigger finger. *J Hand Surg.* 2011;36(6):517. <https://doi.org/10.1177/1753193411409132>
17. Ezzedine K, Whitton M, Pinart M. Interventions for Vitiligo. *JAMA.* 2016;316(16):1708-9. <https://doi.org/10.1001/jama.2016.12399>



# Metachronous breast neoplasms: squamous cell carcinoma and lobular carcinoma *in situ* within a fibroadenoma

Marcelo Moreno<sup>1\*</sup> , Jerso Menegassi<sup>2</sup> , Oswaldo Valentim Zandavalli Neto<sup>2</sup> ,  
Maiane Maria Pauletto<sup>3</sup> , Franciele Meurer<sup>3</sup> 

## ABSTRACT

Breast squamous cell carcinoma are rare, occurring in less than 0.1% of all breast carcinomas. This report describes the oncological conduct performed on a patient with a triple negative squamous cell carcinoma in the upper outer quadrant of the right breast. The same patient presented a lobular carcinoma *in situ* within a fibroadenoma of the contralateral breast, during the follow up period. The association of these two diseases in the same patient has not yet been described in the literature.

**KEYWORDS:** breast neoplasms; squamous cell carcinoma; lobular carcinoma.

## INTRODUCTION

Breast squamous cell carcinoma (SCC) occurs when more than 90% of malignant cells are squamous<sup>1</sup>. Furthermore, the neoplasm cannot be related to cutaneous elements of the breast (skin and areola-papillary complex) and no other invasive cellular components can be present, such as ductal cells<sup>2,3</sup>. The first account of this was described in 1908 by Troell<sup>4</sup>. It is considered to be a rare neoplasm, as it represents less than 0.1% of breast carcinomas<sup>2,5</sup>. For this reason, the publications about it are based on reports or case series that mostly analyze the form of treatment used and the prognosis<sup>5-8</sup>.

Carcinoma inside a fibroadenoma is also uncommon<sup>9</sup>. It is believed that ductal or lobular cells, which characterize a carcinoma, could originate within the pre-existing benign lesion, or both coexist from the beginning<sup>9,10</sup>. Behavior, treatment and prognosis depend on whether the carcinoma component is invasive or *in situ*<sup>11</sup>.

This article reports on the clinical-histological findings and the treatment of a breast SCC diagnosed in a patient who, during an oncological follow-up, also presented a lobular carcinoma *in situ* inside a fibroadenoma.

## CASE REPORT

A 58-year-old white woman came to the consultation to investigate a tumor in her right breast, which had appeared a year before.

The patient reported that the lesion started as a palpable lump inside the breast, grew rapidly and had ulcerated 30 days before. She reported that she had been undergoing breast imaging exams since she was 50 years old and that she had not been diagnosed with a previous lesion at that breast site. A physical examination revealed a 6 × 5.5 cm tumor mass, circumscribed and associated with a central spontaneous drainage hole of necrotic material located in the upper outer quadrant (UOQ) of the right breast, 3 cm from the areola papillary complex. On the mammogram, it was possible to observe a mass that had rounded density, ill-defined contours and similar dimensions to the findings of the physical examination (Figure 1). On the ultrasound, the lesion was well defined, with heterogeneous echogenicity and defined contours. It measured 5.19 × 4.09 cm. Fine needle aspiration puncture (FNAB) of the breast lesion was performed, and a cytopathology described findings compatible with malignant neoplasia. Imaging tests were performed for staging (chest and abdomen tomography), and no signs of distant diseases were found. It was recommended that the patient perform a biopsy of a fragment with a thick needle (core biopsy) to define the histology of the lesion. Then, the form of treatment would be proposed. However, because of a personal request, she was referred to surgery as an initial treatment. The patient underwent a right mastectomy and ipsilateral axillary dissection, and the histopathological description

<sup>1</sup>Universidade Federal da Fronteira Sul – Chapecó (SC), Brazil.

<sup>2</sup>Instituto de Patologia do Oeste – Chapecó (SC), Brazil.

<sup>3</sup>Hospital da Pontifícia Universidade Católica de Porto Alegre – Porto Alegre (RS), Brazil.

\*Corresponding author: marcelo.moreno@uffs.edu.br

Conflict of interests: nothing to declare.

Funding: none

Received on: 04/13/2020. Accepted on: 06/15/2020.



was of a well-differentiated SCC, with a skin invasion. Clusters of malignant squamous cells were present in more than 90% of the examined histological sections. Eighteen axillary lymph nodes were removed, of which, three were affected by the neoplasia (pT4apN1) (Figures 2 and 3). Assessing clinical history, physical examination, histopathological description of the neoplasm, and the fact that the patient had no previous history of SCC diagnosis in another anatomical site, it was considered to be a primary SCC in the mammary gland. The immunohistochemical examination showed negativity for estrogen/progesterone receptors and for HER-2. The patient underwent adjuvant treatment with chemotherapy (cyclophosphamide, methotrexate and 5-fluorouracil) and radiation therapy.

After three years of oncological follow-up, a fibro adenoma associated with a lobular carcinoma *in situ* was diagnosed in the UOQ of the left breast. The fibroadenoma measured 1.2 × 0.8 cm. The lobular carcinoma was 0.4 cm in size and was in the center of the largest lesion. The margins were described to be compromised, as there were more foci of lobular lesion *in situ* in the adjacent breast parenchyma. The diagnosis of the lesion *in situ* was also confirmed by immunohistochemistry, which described a negative lesion for E-cadherin. Because of previous surgery on the right breast, and because of her increased risk of developing more breast cancer, the patient opted for a left adenomastectomy with bilateral reconstruction (placement of bilateral retromuscular expanders, which were replaced by breast implants after six months of tissue expansion). Currently, the patient is asymptomatic, and completing 10 years of clinical follow-up and does not have signs of recurrence of the first neoplasia. This report is part of the research carried out with cancer cases diagnosed in western Santa Catarina and was approved by the Research Ethics Committee of the Universidade Comunitária da Região de Chapecó (opinion no. 069/07).

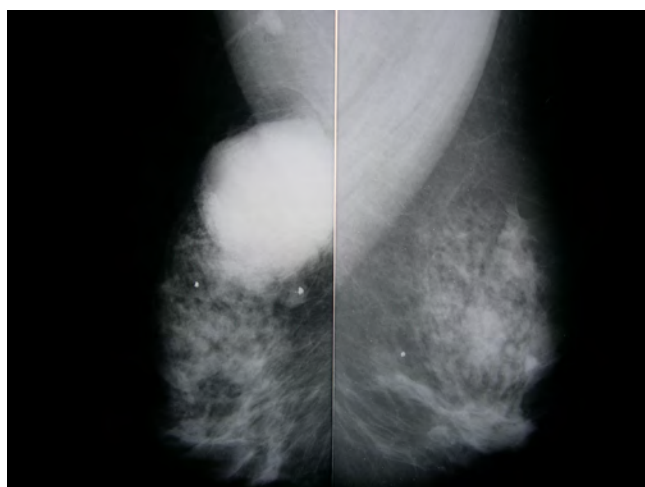

**Figure 1.** Mammography of the right breast in a lateromedial projection showing a large tumor in the upper outer quadrant of the right breast.

## DISCUSSION

The reported incidence of SCC as a primary breast tumor varies between 0.1% and 0.4% in relation to all breast carcinomas<sup>12,13</sup>. This neoplasm has already been described in women aged between 29 and 90 years old, but the diagnosis predominates in patients

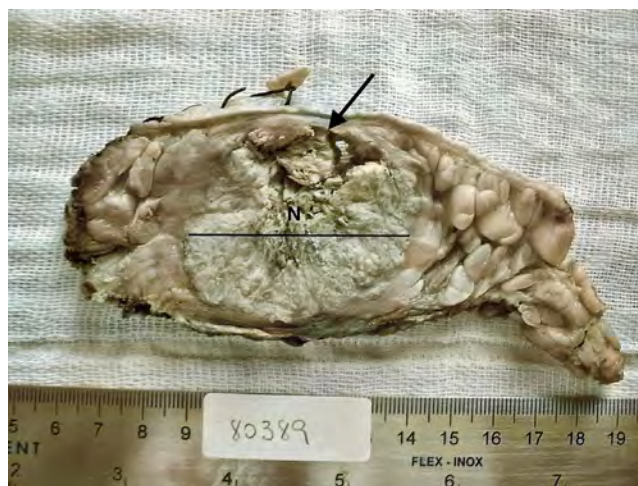

**Figure 2.** A macroscopic examination of the surgical specimen, with a centralized tumor lesion between the breast tissue, containing a central area with necrosis (N) and a skin extension (arrow).

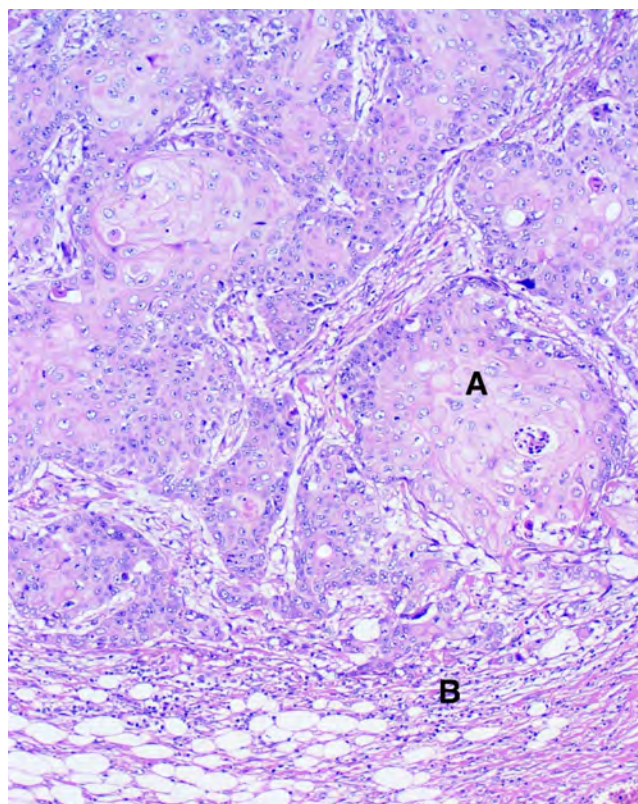

**Figure 3.** Photomicroscopy of primary breast squamous cell carcinoma (H&E 200X). (A) Area with a cluster of malignant squamous neoplastic cells; (B) connective tissue of the adjacent breast parenchyma.

aged 50 to 54 years old<sup>13,14</sup>. They are usually large tumors at the time of the diagnosis (greater than 4 cm), due to rapid growth, which can evolve with central necrosis<sup>12-14</sup>. The reported patient was slightly older than the most frequent age group, and had a clinical presentation similar to that documented in the literature, including a rapid increase in tumor size and the presence of central necrosis that evolved to cutaneous fistulization. To define that SCC as the primary cancer of the breast, it is necessary for the predominant cell type to be squamous cells (more than 90% of the neoplasia area). Furthermore, the lesion cannot have any relation with the overlying skin and there can be no indication of primary SCC in other anatomical sites<sup>12</sup>. The histogenesis of this type of neoplasm has not yet been defined, but it is believed that it may be the result of the evolution of a scaly metaplasia in a previous benign breast lesion<sup>13</sup>. Another possibility is that the SCC originates from an area of squamous metaplasia within an invasive ductal carcinoma<sup>7,8,12,14</sup>. In the case of the patient presented, there was no clinical report or documentation of a previous breast image describing a lesion in the UOQ of the right breast.

There are no specific radiological findings of this neoplasm on mammography exams<sup>13,14</sup>. Ultrasonography may show a nodule with heterogeneous echogenicity that is well defined, or an area with echographic characteristics of a cyst or breast abscess<sup>15,16</sup>. These characteristics were described in the ultrasound examination of the patient's breast lesion reported here.

The main cytological finding in material from FNAB is the presence of malignant squamous cells; and an incisional biopsy is usually necessary for a definitive diagnosis<sup>12-15</sup>. In the case reported, the patient did not want to proceed with further investigation. In view of the clinical aspect of the lesion, she requested to undergo surgical treatment. As a result, there was no histological definition of the neoplasia nor, consequently, the option of neoadjuvant therapy, which made conservative breast surgery impossible.

Usually, primary breast SCCs are neoplasms that do not express estrogen or progesterone receptors<sup>12,13</sup>, and, therefore, hormone therapy is part of the therapeutic arsenal. However, in most cases, there is a positive epidermal growth factor receptor (EGFR), cytokeratin CK5 and CK6, which may explain the high rate of cell proliferation and therefore the poor prognosis<sup>4,15</sup>. The immunohistochemical examination of the neoplasm diagnosed in the present case described a triple-negative neoplasm, which corresponded to that documented in the literature on primary breast SCC. No research was performed on EGFR, CK5 or CK6.

The treatment of breast SCC does not differ from that instituted for other histological types, which may involve surgery, neoadjuvant or adjuvant chemotherapy, and radiotherapy<sup>14,16</sup>.

Radiotherapy plays an important role, considering that most cases have a locally advanced presentation of the disease<sup>17</sup>.

Previous studies indicate that the prevalence of lymph node metastasis varies from 41% to 47%<sup>7,17,18</sup>. Patients with lymph node involvement from the neoplasm seem to have a better response to adjuvant chemotherapy compared to those with no involvement<sup>18</sup>. However, surgery is considered the main choice in order to manage the disease. A radical mastectomy is the most commonly used mainly due to the tumor size in the initial presentation<sup>19</sup>.

Clinical progression is generally poor, and the most important prognostic factor is the size of the primary lesion at the time of the diagnosis. Tumors with a diameter greater than 5 cm are associated with a greater chance of systemic recurrences<sup>19</sup>. Five-year survival ranges from 60% to 75%<sup>16,19</sup>.

In addition to the rarity of the first tumor, the patient developed lobular carcinoma *in situ* in fibroadenoma in the contralateral breast, during the third year of cancer follow-up. The association between carcinoma and fibroadenoma is also considered to be rare<sup>9</sup>. In a series that evaluated 30 cases with this association, 53.3% had invasive ductal carcinoma, followed by 23.3% having ductal carcinoma *in situ*, 16.7% having lobular carcinoma *in situ* and 13.3% having invasive lobular carcinoma<sup>10</sup>. It is normally diagnosed in women aged between 44 and 47 years old<sup>9,10</sup>. This finding is usually incidental and occurs after surgical removal of a fibroadenoma<sup>10,11</sup>. Whatever the type of neoplasm associated with fibroadenoma (*in situ* or invasive, lobular or ductal), the biological behavior is the same as for carcinomas that originate outside the fibroadenoma<sup>11</sup>.

Treatment follows the pattern for non-fibroadenoma-related carcinomas. In the case of carcinoma *in situ* originating within a fibroadenoma, conservative treatment is recommended. However, because lobular carcinoma *in situ* is associated with an increased risk of developing breast cancer, a prophylactic mastectomy may be considered (if the patient has clinical criteria or laboratory tests that characterize genetic mutation)<sup>9-11</sup>.

The case presented here has the particularity of primary breast SCC, with a clinical presentation, radiological findings, a histological diagnosis, and an immunohistochemistry with the same characteristics as the cases described in the literature. In the oncological follow-up, it was possible to diagnose the second neoplasia in a period of three years and to carry out complementary surgical treatment. Due to the fact that the patient had previously undergone a right mastectomy due to a rare neoplasm and because she had a new lesion associated with an increased risk of developing another breast cancer, we opted for an adenomastectomy on the left, with immediate reconstruction and a tissue expander, and subsequent prosthesis replacement in both breast sites.

## CONCLUSION

Primary breast SCC is rare and is associated with a worse prognosis than unspecified breast carcinoma. Lobular carcinoma *in situ*, originating within a fibroadenoma, is also an uncommon diagnosis. In the case reported, these two neoplasms were diagnosed metachronously, and it was possible to adjust the conduct of each one according to what is recommended in the literature. The patient has survived disease-free for 10 years, despite the fact that the initial stage of SCC is normally related to a worse prognosis. The diagnosis of the second neoplasm was only possible through adequate oncological follow-up.

## AUTHORS' CONTRIBUTION

M.M.: Design, acquisition of funding, investigation, methodology, project administration, supervision, validation, visualization, writing – reviewing and editing.

J.M.: Acquisition of funding, investigation, methodology, writing – reviewing and editing.

O.N.: Acquisition of funding, investigation, methodology, writing – reviewing and editing.

M.P.: Design, acquisition of funding, investigation, methodology, writing – reviewing and editing.





F.M.: Design, acquisition of funding, investigation, methodology, writing – reviewing and editing.

## REFERENCES

- Schmitt G, Gobbi H. Mama. In: Bogliolo Filho G, editor. *Bogliolo Patologia*. 9ª ed. Rio de Janeiro: Guanabara Koogan; 2016. p. 613-43.
- Rosen PR. *Patologia da mama de Rosen*. Philadelphia: Lippincott Williams & Wilkins; 2017. p. 455-61.
- Lester SC. A mama. In: Kumar V, Abbas AK, Fausto N, Aster JC, editores. *Patologia Bases Patológicas das Doenças*. 9ª ed. Rio de Janeiro: Elsevier; 2016. p. 1073-103.
- Troell A. Zwei Falle von Paltteneithelcarcinom. *Nord Med Arca*. 1908;1:1-11.
- Behranwala KA, Nasiri N, Abdullah N, Trott PA, Gui GPH. Squamous cell carcinoma of the breast: clinico-pathologic implications and outcome. *Eur J Surg Oncol*. 2003;29(4):386-9. <https://doi.org/10.1053/ejso.2002.1422>
- Gupta C, Malani AK, Weigand RT, Rangineni G. Pure primary squamous cell carcinoma of the breast: A rare presentation and clinicopathologic comparison with usual ductal carcinoma of the breast. *Pathol Res Pract*. 2006;202(6):465-9. <https://doi.org/10.1016/j.prp.2006.01.006>
- Pirot F, Chaltiel D, Ben Lakhdar A, Mathieu MC, Rimareix F, Conversano A. Squamous cell carcinoma of the breast, are there two entities with distinct prognosis? A series of 39 patients. *Breast Cancer Res Treat*. 2020;180(1):87-95. <https://doi.org/10.1007/s10549-020-05525-5>
- Soliman M. Squamous cell carcinoma of the breast: A retrospective study. *Am Surg*. 2019;15(5):1057-61. [https://doi.org/10.4103/jcrt.jcrt\\_303\\_17](https://doi.org/10.4103/jcrt.jcrt_303_17)
- Saimura M, Koga K, Anan K, Mitsuyama S, Tamiya S. Diagnosis, characteristics, and treatment of breast carcinomas within benign fibroepithelial tumors. *Breast Cancer*. 2018;25(4):470-8. <https://doi.org/10.1007/s12282-018-0847-7>
- Wu Y-T, Chen S-T, Chen C-J, Kuo Y-L, Tseng L-M, Chen D-R, et al. Breast cancer arising within fibroadenoma: collective analysis of case reports in the literature and hints on treatment policy. *World J Surg Oncol*. 2014;12:335. <https://doi.org/10.1186/1477-7819-12-335>
- Limite G, Esposito E, Sollazzo V, Ciancia G, Formisano C, Di Micco R, et al. Lobular intraepithelial neoplasia arising within breast fibroadenoma. *BMC Res Notes*. 2013;6:267. <https://doi.org/10.1186/1756-0500-6-267>
- Honda M, Saji S, Horiguchi S, Suzuki E, Aruga T, Horiguchi K, et al. Clinicopathological analysis of ten patients with metaplastic squamous cell carcinoma of the breast. *Surg Today*. 2011;41(3):328-32. <https://doi.org/10.1007/s00595-009-4276-2>
- Anne N, Sulger E, Pallapothu R. Primary squamous cell carcinoma of the breast: a case report and review of the literature. *J Surg Case Rep*. 2019;2019(6):182. <https://dx.doi.org/10.1093%2Fjscr%2F19jz182>
- Murialdo R, Boy D, Musizzano Y, Tixi L, Murelli F, Ballestrero A. Squamous cell carcinoma of the breast: a case report. *Cases J*. 2009;2:7336. Squamous cell carcinoma of the breast: a case report. *Cases Journal*.
- Aparicio I, Martínez A, Hernández G, Hardisson D, De Santiago J. Squamous cell carcinoma of the breast. *Eur J Obstet Gyn R B*. 2008;137(2):222-6. <https://doi.org/10.1016/j.ejogrb.2007.03.021>
- Badge SA, Gangane NM, Shivkumar VB, Sharma SM. Primary squamous cell carcinoma of the breast. *Int J Appl Basic Med Res*. 2014;4(1):53-5. <https://dx.doi.org/10.4103%2F2229-516X.125697>
- Gupta N, Vashisht R, Nimbran V, Gupta R, Dhingra N, Bhutani A. Primary squamous cell carcinoma of the breast: Case report and management decisions. *J Cancer Res Ther*. 2012;8(2):323-5. <https://doi.org/10.4103/0973-1482.99006>
- Liu J, Yu Y, Sun J, He S, Wang X, Yin J, et al. Clinicopathologic characteristics and prognosis of primary squamous cell carcinoma of the breast. *Breast Cancer Res Treat*. 2015;149(1):133-40. <https://doi.org/10.1007/s10549-014-3224-z>
- Hennessy BT, Krishnamurthy S, Giordano S, Buchholz TA, Kau SW, Valero ZDV, et al. Squamous Cell Carcinoma of the Breast. *J Clin Oncology*. 2005;23(31):7827-35. <https://doi.org/10.1200/JCO.2004.00.9589>



# Synchronic presentation of breast ductal carcinoma and follicular lymphoma: a diagnostic challenge

Priscila Nunes Silva Morosini<sup>1\*</sup> , Murilo do Valle Sabóia<sup>1</sup> ,  
Tereza Cavalcanti<sup>2</sup> , Ágata Rothert<sup>1</sup> , Marcela Cavalcanti<sup>2</sup> 

## ABSTRACT

Synchronic tumors are rare events, even more clinically presenting as a rational metastatic sequence: breast cancer followed by axillary lymph node involvement. In the present case, after mastectomy associated with axillary emptying in a postmenopausal patient, we identified in the pathological report the presence of breast disease: invasive ductal carcinoma. However, differently from what was expected by the clinical examination, axillary lymph node involvement was not due to a disease of mammary origin, but to non-Hodgkin's lymphoma — a new primary. In the world literature, there are few similar reports, and it is still necessary to accumulate similar cases to be able to hypothesize a single causality between these two tumor subtypes or cause-consequence relationship between the two entities.

**KEYWORDS:** Lymphoma; Neoplasms, multiple primary; Breast neoplasms.

## INTRODUCTION

The presentation of synchronous neoplasms is rare<sup>1,2</sup>. In the case of breast cancer, the presence of ipsilateral axillary lymph node enlargement denotes, in clinical terms, lymphatic involvement by the breast disease initially diagnosed. Therefore, the diagnosis of synchronicity of two primary neoplastic diseases, one mammary and the other lymph node, occurs in a post-surgical moment, given the rarity of the condition.

What is known in the literature is the increased incidence of non-Hodgkin's lymphoma in patients treated for malignant breast cancer who underwent radiotherapy<sup>3</sup>, thus a context of metachronous disease.

Some authors, however, have reported cases of primary breast cancer and lymphoma at the initial diagnosis<sup>4</sup>. At the moment, it is not clear whether these cases arise through common underlying mechanisms, causing a parallel trigger, or whether the disease process is totally independent of each other.

Given the rarity of the process and the complete strategic difference in the management of these two distinct entities, there is, of course, a lack of consensus on the ideal treatment strategy<sup>1</sup>.

## CASE REPORT

A 69-year-old female patient was referred to the mastology service due to changes in routine screening mammography, denying having noticed nodulations or other changes in the breasts. She had no previous surgical procedure or previous radiotherapy. The family history was significant, with one sister previously diagnosed with breast neoplasm and another sister with a history of bladder cancer.

Hypothyroidism was being treated as the only comorbidity and continuous use medication. Multiparous, G3P1C2, and menopause at 53 years old, during the initial visit, she denied complaints compatible with symptoms B, with no fever, night sweats, or unintentional weight loss.

On physical examination, a palpable nodule in the left breast was found, at the junction of the upper quadrants, 3.5 × 2.5 cm, and a suspected bulky movable palpable ipsilateral axillary lymph node enlargement; therefore, clinically a T2N1Mx.

The modified screening mammogram showed a 15 mm node in the left breast with well-defined limits. Complementary ultrasound revealed a left breast with multiple simple cysts, the largest was 1.3 cm retroareolar. The right axilla had a 2.5 cm lymph node

<sup>1</sup>Department of Mastology, Hospital São Vicente, High Complexity Assistance Unit (Unacon) – Curitiba (PR), Brazil.

<sup>2</sup>Department of Pathology, NeoPath Diagnostic Pathology – Curitiba (PR), Brazil.

\*Corresponding author: priscilamorosini@hotmail.com

Conflict of interests: nothing to declare.

Received on: 06/15/2020. Accepted on: 07/02/2020

with a reactional aspect, and the left axilla, a palpable mass with atypical lymph nodes grouped in different sizes, the largest measuring 3.9 cm. Some discrepancies between the measurements of the lesion on the clinical examination and the imaging findings are probably related to differences in dates between them and also to the possibility of, at clinical examination, the lesion area being overestimated.

After the first visit to our service, the patient underwent a left breast core biopsy and a fine needle aspiration biopsy (FNAB) of the left axillary lymph nodes. The anatomopathological report showed a well-differentiated invasive breast ductal carcinoma and an associated 1 cm satellite node, with a report of nuclear grade 2 intraductal carcinoma. The immunohistochemical assessment showed a positive response to estrogen receptor and negative response to the progesterone receptor (ER+++ 95%; PR-; HER 2-; Ki67 8%); therefore, a luminal B. The FNAB of the axillary lymph nodes did not show malignancy in the sample, indicating further investigation in the case of a suspected lesion. Tomographic staging of the chest, abdomen, and pelvis did not signal additional secondary involvement, demonstrating only axillary lymph node enlargement measuring up to 2.2 cm.

Next, the patient underwent a radical mastectomy and axillary lymphadenectomy with an adjuvant chemotherapy plan, without immediate reconstruction by her own decision. The final anatomopathological report of the surgical specimen revealed a well-differentiated invasive ductal breast carcinoma associated with intraductal carcinoma, with 2.7 × 1.9 × 1.8 cm and free margins.

As for axillary lymphadenectomy, 45 lymph nodes were removed, all without evidence of involvement by carcinoma, but there was a finding of atypical proliferation strongly suspected for follicular lymphoma, with post-surgical staging pT2pN0 in relation to breast cancer (Figure 1).

Complementary immunohistochemistry of the surgical specimen showed CD 10 expression (Figure 2) and positive Bcl-6 and Bcl-2 — a condition compatible with grade 1-2 follicular lymphoma (predominantly follicular > 75%).

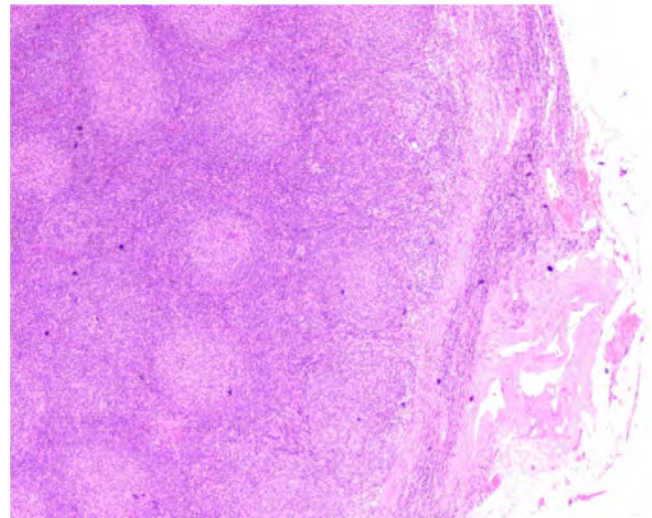

**Figure 1.** H&E 40 × lymph node cut with cortical and medullary architecture replaced by neoplastic follicles.

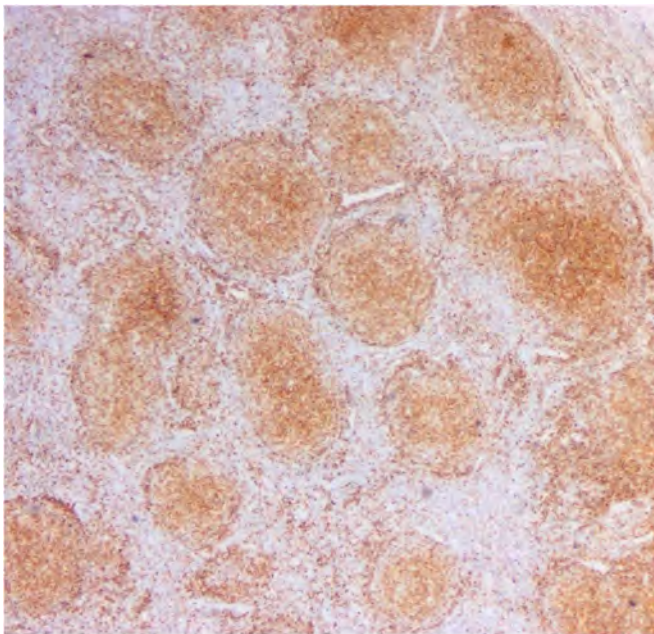

**A**

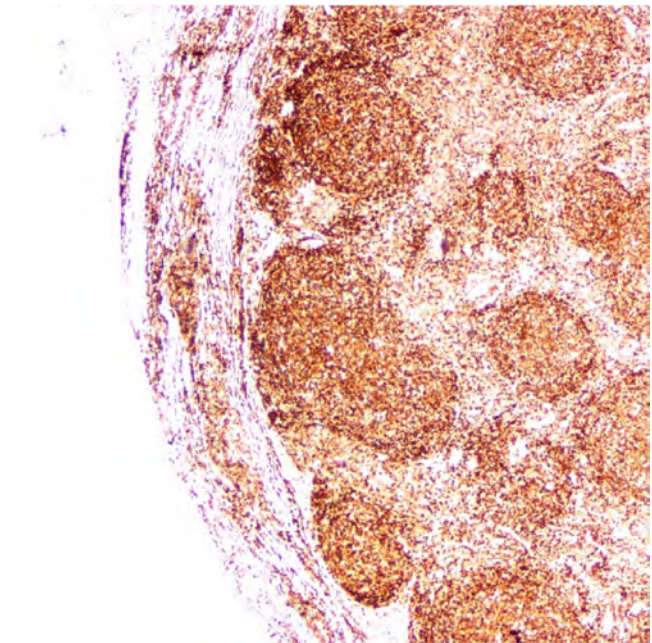

**B**

**Figure 2.** H&E 40 × Cd10 and Bcl2 positive in follicular cells enhancing germinal centers.

The patient is currently undergoing treatment for lymphoma at the hematology service and is being followed up at Hospital São Vicente, in Curitiba, with hormone therapy. She is following follow-up.

## DISCUSSION

The first extramammary site affected by breast cancer is usually the axillary lymphatic chain. Therefore, the rationalization leads us to believe that, in the presence of an axillary lymph node block in a patient with invasive ductal carcinoma of the ipsilateral breast, it is a case of lymph node involvement by carcinoma of mammary origin.

However, in the case described here and in a few similar ones reported in the literature, there is a synchronous involvement of two primary tumors, a carcinoma and a lymphoma.

In 2015, Michalinos et al. reported a similar situation in which a postmenopausal patient also presented intraductal carcinoma and lymphoma, in this case clinically manifested in axillary lymph nodes ipsilateral to the breast lesion and in the inguinal region. In the follow-up, this patient presented a mammographic alteration and histological diagnosis of invasive ductal HER2+ carcinoma, treated with trastuzumab. Furthermore, the authors suggest the hypothesis that the breast tumor may induce an inflammatory lymph node response that evolves to a non-Hodgkin lymphoma<sup>1</sup>.

In 2016, Woo et al. also encountered a case of tumor synchronicity. In their literature review, they presented another 87 similar cases, with diagnoses of synchronic breast-lymphoma disease. In most cases, the presentation was after menopause, and the diagnosis of the second neoplasm was made after beginning the first treatment, as in our case<sup>2</sup>.

All cases reported with this context of neoplasm synchronicity are a real therapeutic challenge, given the great difference in treatment between the two diseases<sup>1,2,5</sup>.

## CONCLUSION

This report allows us to discuss several aspects about the synchronous presentation of the primary breast tumor and lymphoma, among them: the delay in the diagnosis of the secondary neoplasm, the consequent delay in defining the diagnostic strategy, and the prognosis related to the two pathological processes in the synchronous presentation. The literature reviews already carried out show that 88.9% of the case reports failed to diagnose the second neoplasm<sup>1</sup>. Fine needle biopsy and even *core* biopsy of these lymph nodes usually do not guarantee the diagnosis because of the high false-negative rates for these cases, and their findings are often insufficient<sup>4</sup>.

Imaging diagnosis is usually not enlightening in these cases<sup>2</sup>, and, in general, the diagnosis occurs after surgical treatment and the final histological assessment.

## AUTHORS' CONTRIBUTIONS

P.M.: case management, literature review, data collection from medical records, writing, and text review.

M.S.: case management.

A.R.: literature review, data collection from medical records, writing.

M.C.: slide review in pathology and anatomopathological reports, production of case images.







T.C.: anatomopathological analysis and report, immunohistochemical diagnosis, case review.

## REFERENCES

1. Michalinos A, Vassilakopoulos T, Levidou G, Korkolopoulou P, Kontos M. Multifocal Bilateral Breast Cancer and Breast Follicular Lymphoma: A Simple Coincidence? *J Breast Cancer*. 2015;18(3):296-300. <https://dx.doi.org/10.4048%2Fjbc.2015.18.3.296>
2. Woo EJ, Baugh AD, Ching K. Synchronous presentation of invasive ductal carcinoma and mantle cell lymphoma: a diagnostic challenge in menopausal patients. *J Surg Case Rep*. 2016;2016(1):rjv153. <https://dx.doi.org/10.1093%2Fjscr%2Frjv153>
3. Sordi E, Cagossi K, Lazzaretti MG, Gusolfino D, Artioli F, Santacroce G, et al. Rare Case of Male Breast Cancer and Axillary Lymphomains the Same Patient: An Unique Case Report. *Case Rep Med*. 2011;2011:940803. <https://dx.doi.org/10.1155%2F2011%2F940803>
4. Liu J, Wei H, Zhu K, Lai L, Han X, Yang Y. Male breast cancer and mantle cell lymphoma in a single patient A case report and literature review. *Medicine*. 2017;96(48):e8911. <https://dx.doi.org/10.1097%2FMD.00000000000008911>
5. Hahm MH, Kim HJ, Shin KM, Cho SH, Park JY, Jung JH, et al. Concurrent Invasive Ductal Carcinoma of the Breast and Malignant Follicular Lymphoma, Initially Suspected to Be Metastatic Breast Cancer: A Case Report. *J Breast Cancer*. 2014;17(1):91-7. <https://dx.doi.org/10.4048%2Fjbc.2014.17.1.91>



# Breast cancer and pyoderma gangrenosum: a complication after conservative surgery and radiotherapy

Flávia Kuroda<sup>1,2\*</sup> , Cicero Urban<sup>1</sup> , Erica Mendes<sup>3</sup> , Anelise Rocha Raymundo<sup>4</sup> ,  
Alessandra Amatuzzi Cordeiro Fornazari<sup>1</sup> , Teodora Roballo Durigan<sup>5</sup> 

## ABSTRACT

Pyoderma gangrenosum (PG) is a rare, ulcerative, and painful neutrophilic dermatosis of unknown cause associated with systemic diseases and/or pathergy phenomenon in 30% of cases. We report the case of a breast cancer patient submitted to oncoplastic conservative surgery followed by adjuvant radiotherapy, with long-term progression to PG. It's rare and challenging nature reinforces the need for early diagnosis to increase treatment effectiveness and reduce morbidity.

**KEYWORDS:** Pyoderma gangrenosum. Breast cancer. Radiotherapy. Breast conserving surgery. Corticoids.

## INTRODUCTION

Pyoderma gangrenosum (PG) is a dermatological inflammatory disease resulting from innate immune system dysfunction, with highly heterogeneous presentation and course<sup>1,2</sup>. It is a rare neutrophilic dermatosis characterized by papule, pustule, and vesicle formation rapidly progressing to painful skin ulcers, often located in the lower limbs, although they have been reported on the head, breast, oral cavity, trunk, perineum, and upper limbs<sup>1,3</sup>. These skin lesions present well-defined edges, peripheral erythema, moist base, subcutaneous tissue necrosis, painful high sensitivity, sup-puration, and occasional bleeding<sup>4,5</sup>. The disease presents great morbidity, and its course may be chronic or recurrent.

Although they may occur spontaneously, more than 50% of lesions develop due to skin hyperactivity at trauma sites, with special emphasis on postoperative ones (PPG)<sup>6,7</sup>. Multiple case reports have described the progress of PG after cosmetic, oncologic, and reconstructive breast surgery, but few PG reports address breast cancer after conservative surgery associated with radiotherapy.

## CASE REPORT

This case report describes a 50-year-old Caucasian, nulligravida patient with a history of hiatus hernia, dyslipidemia, and

hypothyroidism, taking omeprazole, simvastatin, and levothyroxine. She also had a previous history of fibroids hysterectomy surgery, and a family history of breast cancer (her mother died at the age of 50 years).

The patient had a T2N0M0 left breast cancer – grade 2 invasive ductal subtype, triple-negative, and Ki-67 40%. She received neoadjuvant chemotherapy (CT) (doxorubicin and cyclophosphamide, followed by taxane – AC-T + carboplatin), which ended on February 6, 2018. On March 19, 2018, she underwent quadrantectomy + sentinel lymph node biopsy (SLNB) on the left side and bilateral oncoplastic surgery, using the lower pedicle technique (Figure 1). On the 15<sup>th</sup> postoperative day, the patient developed small dehiscence in the left breast T area, which was resutured. The wound healed completely, and the patient was referred to radiotherapy. She received left-breast external conformational radiotherapy at a total dose of 50 Gy (30 fractions) and a 60 Gy boost (30 fractions), ending on July 11, 2018. The patient progressed well with grade 1 radiodermatitis in the treated area.

In October 2019 (19<sup>th</sup> postoperative month and 15<sup>th</sup> post-radiotherapy month), she developed small periareolar ulceration on the left breast (Figure 2). At that time, infection was suspected, and the patient was treated with debridement, Hydrofiber dressing with silver and non-adherent membrane, and antibiotic therapy

<sup>1</sup>Mastology Department, Hospital Nossa Senhora das Graças – Curitiba (PR), Brazil.

<sup>2</sup>Post-graduation Program in Biotechnology, Universidade Positivo – Curitiba (PR), Brazil.

<sup>3</sup>CLINIPAM – Curitiba (PR), Brazil.

<sup>4</sup>Dermatology Department, Santa Casa de Misericórdia de Curitiba – Curitiba (PR), Brazil.

<sup>5</sup>Universidade Positivo – Curitiba (PR), Brazil.

\*Corresponding author: flaviakuroda@hotmail.com

Conflict of interests: nothing to declare.

Received on: 06/16/2020. Accepted on: 07/16/2020

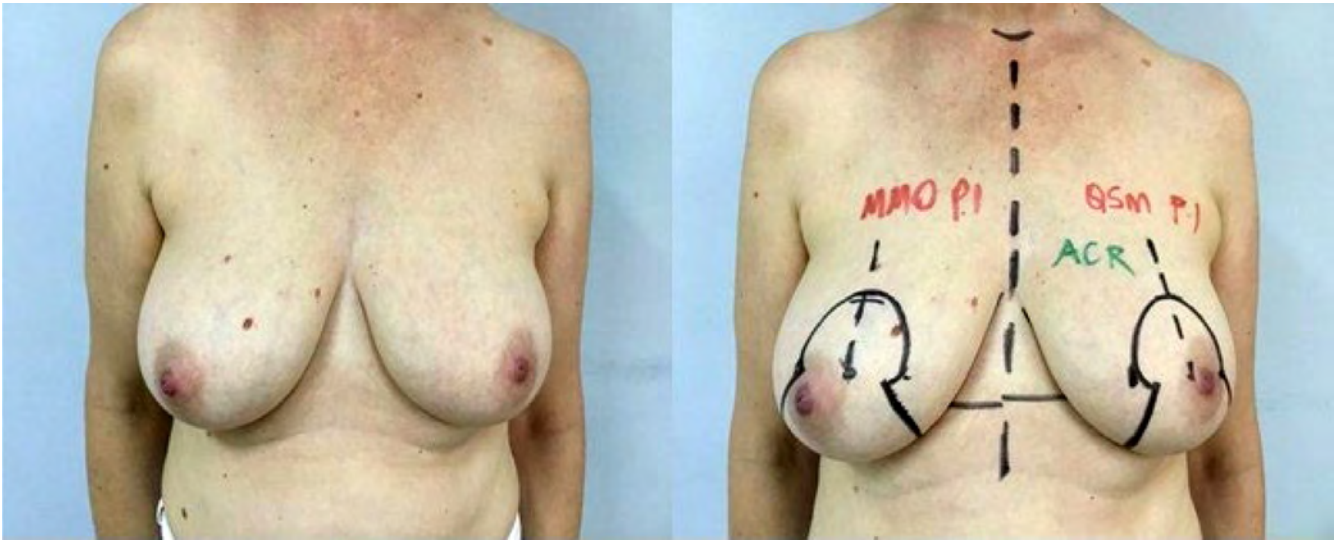

**Figure 1.** Preoperative surgical planning.



**Figure 2.** Pyoderma gangrenosum lesion progression. (A and B) October 2019 (19<sup>th</sup> postoperative month and 15<sup>th</sup> post-radiotherapy month). (C) November 2019: ulcer progression with necrosis foci. (D and E) December 2019: ulcer involving the entire breast, excluding the nipple and part of the areola.



(cefadroxil) for 21 days. The crusted ulcer gradually progressed, with necrotic foci and intense pain (Figure 2). In December 2019, the lesion had affected the entire breast, excluding the nipple and part of the areola (Figure 2). The patient was taking dipyrrone, naproxen, and codeine/paracetamol, without pain control, and receiving wound dressing care.

On December 4, 2019, she was admitted for complementary tests, culture collection, and incisional biopsy. On that occasion, laboratory tests, upper endoscopy, colonoscopy, bone scintigraphy, and chest, abdominal, and pelvic computed tomography were performed, all of them without evidence of abnormalities. Based on the clinical history and progress, PG was the main diagnostic hypothesis, and an empirical treatment was started with oral prednisone at 80 mg once a day + local use of a porous regeneration membrane during hospitalization. On the 15<sup>th</sup> day of corticotherapy, the patient reported 70% to 80% pain improvement.

Histopathological results showed moderate epithelial hyperplasia, as well as chronic and severe acute neutrophilic inflammation. General bacterioscopy and mycobacteria and fungi culture were negative, but common germ culture was positive for *Burkholderia cepacia* and *Citrobacter freundii* complex.

During oral corticosteroid treatment, tiredness, weight gain, and lower limb pain were the patient's main complaints. One month after treatment, she reported significant pain reduction and progressive improvement in wound appearance. In a period of two months using corticosteroid associated with Protopic® (tacrolimus), the wound had small residual ulcerated areas at the lesion edges (Figure 3). In three months, she was completely healed (Figure 3). Oral corticosteroid weaning was then initiated, firstly with 60 mg for 14 days, followed by 40 mg

for another 14 days, and finally, 20 mg for 14 days. The patient completed corticosteroid weaning in May 2020, and her wound is now completely healed (Figure 3).

## DISCUSSION

PG is considered a rare disease, with an estimated prevalence of 3 cases per 100,000 people, and 0.63 new cases diagnosed per year per 100,000 people<sup>1</sup>. The disease presents a slight female predominance, and its incidence peak occurs between 20 and 50 years of age, with children and adolescents representing only 4% of cases<sup>3</sup>. PG pathogenesis is not well known, but the condition is associated with underlying diseases, such as inflammatory bowel disease, rheumatoid arthritis, psoriatic arthritis, autoimmune hepatitis, hidradenitis suppurativa, acne, and hematologic disorders, in 50% to 70% of cases<sup>8,9</sup>. In the present context, the patient had no previous history of these underlying diseases, and nothing significant was identified during the investigation.

PG diagnosis is mainly clinical and can be exclusionary, especially in case of a previous wound history, subjecting the patient to repeated antibiotic therapy and ineffective debridements<sup>10-12</sup>. PG is currently classified into four clinical subtypes, based on its morphology: classic (ulcerative), bullous, pustular, and vegetative<sup>1</sup>. These subtypes may coexist, but in general, the classical form is the most common, with pain being one of the main symptoms in this case<sup>7</sup>. Although they may occur spontaneously, more than 50% of lesions develop due to skin hyperactivity at trauma sites, with special emphasis on PPG, i.e., in these cases (30%), the pathergy phenomenon is essential<sup>6,7</sup>. In PPG, after a period of typical appearance (between four and six weeks), the



**Figure 3.** Pyoderma gangrenosum lesion progression after the start of corticotherapy. (A) 2 months of treatment: small ulcerated areas at the lesion edges. (B) 3 months of treatment: healed wound and start of corticosteroid weaning. (C) Complete corticosteroid post-weaning: fully healed wound.

surgical wound shows small dehiscence that usually coalesce into large ulceration areas in a process that goes beyond the surgical wound. Granulation tissue is practically non-existent, and pain is inconstant.

In general, breasts are an unusual site for PG manifestation, but we underline that approximately 80% of known breast PG cases are postoperative ones<sup>13,14</sup>. In a systematic review that included 87 PPG cases followed by cosmetic and reconstructive breast surgery, most of them (44%) occurred after reduction surgery, and 16% after breast reconstruction by microsurgery<sup>15</sup>. A total of 32 cases (37%) were associated with breast cancer and 17% with autoimmune diseases<sup>15</sup>. In another review based on Latin American statistics from 1981 to 2018, 96 out of 232 PG cases were found in Brazil<sup>1</sup>. Only 11 of these cases were associated with breast procedures (eight breast reductions, one breast implant, one phyllodes tumor, and one post-quadrantectomy case)<sup>1</sup>. The case described above presented a classical morphological progression (ulcerative), starting at the periareolar incision and extending throughout the breast, excluding the nipple. Contrary to the specialized literature, the lesion developed later, after the pathergy phenomenon – 19 months after cancer surgery.

PG has no gold standard treatment due to a lack of randomized controlled studies; however, the method most frequently reported is based exclusively on systemic steroid administration, followed by the combination of systemic steroids and corticosteroid-sparing agents<sup>3,16</sup>. Possible options include dexamethasone, cyclosporine, colchicine, thalidomide, sulfonamide, azathioprine, mycophenolate mofetil, tumor necrosis factor  $\alpha$  (TNF- $\alpha$ ) inhibitors, calcineurin inhibitors, immunoglobulin, and surgery<sup>3</sup>.

In a systematic review on post-breast surgery PG, the most common treatments were steroids with 73 cases (84%) and/or cyclosporine A (22%)<sup>15</sup>. A few cases employed infliximab (n = 2), tacrolimus (n = 3), adalimumab (n = 1), and hyperbaric oxygen therapy (n = 4). Rapid response to immunosuppressive therapy was reported in most cases, with a mean treatment duration of 4.7 months. Skin grafting was performed in 19 patients, and local rotation or free flap in 11<sup>15</sup>. The case described showed a rapid response to steroid and complete lesion remission after three months of treatment, even though the breast had been previously irradiated.

## CONCLUSION

PG is rare and challenging for the differential diagnosis of breast diseases. Knowledge related to clinical presentation, predisposing factors, and risk surgical conditions can contribute to early diagnosis and avoiding progress to extremely severe as well as treatment-resistant cases.

## AUTHORS' CONTRIBUTIONS

F.K.: study concept, data curation, formal analysis, methodology, project management, writing – review & editing.

C.U.: study concept, data curation, formal analysis, methodology, project management, writing – review & editing.

E.M.: data curation, methodology.

A.R.R.: data curation, methodology.

A.A.C.F.: research, validation, formal analysis, writing – review & editing.

T.R.D.: research, writing – original draft.





## REFERENCES

- Rodríguez-Zúñiga MJM, Heath MS, Gontijo JRV, Ortega-Loayza AG. Pyoderma gangrenosum: a review with special emphasis on Latin America literature. *An Bras Dermatol*. 2019;94(6):729-43. <http://dx.doi.org/10.1016/j.abd.2019.06.001>
- Mella JR, Maselli AM, Guo L. A Deceptive Diagnosis: Pyoderma Gangrenosum After Breast Surgery-A Case Series and Literature Review. *Ann Plast Surg*. 2019;83(Supl. 4):S21-30. <http://dx.doi.org/10.1097/SAP.0000000000002101>
- Kechichian E, Haber R, Mourad N, El Khoury R, Jabbour S, Tomb R. Pediatric pyoderma gangrenosum: a systematic review and update. *Int J Dermatol*. 2017;56(5):486-95. <http://dx.doi.org/10.1111/ijd.13584>
- Maverakis E, Ma C, Shinkai K, Fiorentino D, Callen JP, Wollina U, et al. Diagnostic criteria of ulcerative Pyoderma Gangrenosum - A Delphi Consensus of international experts. *JAMA Dermatol*. 2018;154(4):461-6. <http://dx.doi.org/10.1001/jamadermatol.2017.5980>
- Brunsting LA, Goeckerman WH, O'Leary PA. Pyoderma (ecthyma) gangraenosum - clinical and experimental observations in five cases occurring in adults. *Arch Derm Syphilol*. 1930;22(4):655-80. <http://dx.doi.org/10.1001/archderm.1930.01440160053009>
- Billings SD. Common and critical inflammatory dermatoses every pathologist should know. *Mod Pathol*. 2020;33:107-17. <http://dx.doi.org/10.1038/s41379-019-0400-z>
- Bonamigo RR, Razera F, Olm GS. Dermatoses neutrofilicas - Parte I. *An Bras Dermatol*. 2011;86(1):11-27. <https://doi.org/10.1590/S0365-05962011000100002>
- Alavi A, French LE, Davis MD, Brassard A, Kirsner RS. Pyoderma Gangrenosum: An Update on Pathophysiology, Diagnosis and Treatment. *Am J Clin Dermatol*. 2017;18(3):355-72. <http://dx.doi.org/10.1007/s40257-017-0251-7>
- Kandula P, Shah K, Wolverson JE, Le C, Wolverson ES. Pyoderma gangrenosum: a presenting sign of myelodysplastic syndrome in undiagnosed Fanconi anemia. *Dermatol Online J*. 2019;25(1):13030/qt9xj8b544.

10. Guaitoli G, Piacentini F, Omarini C, Andreotti A, Palma E, Papi S, et al. Post-surgical pyoderma gangrenosum of the breast: needs for early diagnosis and right therapy. *Breast Cancer*. 2019;26(4):520-3. <http://dx.doi.org/10.1007/s12282-018-00940-5>
11. Gosch MC, Guaya IP, Medina MR, Stefanazzi M, Pinilla JP, Leyton GM, et al. Pioderma Gangrenoso de la Mama: Reporte de un caso y revisión de la literatura. *Rev Chil Dermatol*. 2012;28(4):439-43.
12. Weenig RH, Davis MDP, Dahl PR, Su WPD. Skin ulcers misdiagnosed as pyoderma gangrenosum. *N Engl J Med*. 2002;347(18):1412-8. <http://dx.doi.org/10.1056/NEJMoa013383>
13. Tomoda Y, Kagawa S, Kurata S, Tanaka K. Pyoderma gangrenosum of the breast. *BMJ Case Rep*. 2018;11(1):e228243. <http://dx.doi.org/10.1136/bcr-2018-228243>
14. Tuffaha SH, Sarhane KA, Mundinger GS, Broyles JM, Reddy SK, Azoury SC, et al. Pyoderma Gangrenosum after Breast Surgery: Diagnostic Pearls and Treatment Recommendations Based on a Systematic Literature Review. *Ann Plast Surg*. 2016;77(2):e39-e44. <http://dx.doi.org/10.1097/SAP.0000000000000248>
15. Ehrl DC, Heidekrueger PI, Broer PN. Pyoderma gangrenosum after breast surgery: A systematic review. *J Plast Reconstr Aesthetic Surg*. 2018;71(7):1023-32. <http://dx.doi.org/10.1016/j.bjps.2018.03.013>
16. Busato WM de M, Pontes LT, Velho PENF, Magalhães RF. Pioderma gangrenoso da mama - relato de caso e aspectos relevantes para o diagnóstico precoce. *Diagn Trat*. 2016;21(2):65-9.



# Fibroadenoma in axillary accessory breast: a case report

Bruno Eduardo Pereira Laporte<sup>1</sup> , Hakayna Calegari Salgado<sup>1</sup> , Nathália Mussi Monteze<sup>2</sup> , João Matheus de Castro Rangel<sup>1</sup> , Miralva Aurora Galvão Carvalho<sup>1\*</sup> , Samuel Drumond Esperança<sup>3</sup> 

## ABSTRACT

The mass are among the possible alterations observed in the axilla. When found, the most frequent differential diagnosis are lymphadenopathy, metastatic lymphadenomegaly, lymphoma, lipoma or tumors in the apocrine glands. Besides that, the presence of accessory breast tissue must also be considered and, as the topical breast tissue, can be the target of breast diseases, either benign or malignant. Female patient, 23 years old, with the presence of hardened palpable node in the right axilla. At the ultrasound, it presented characteristics that classified it as Bi-Rads<sup>®</sup> 4. An aspiration biopsy of the node was performed with fine-needle, which resulted in unsatisfying material. After the explanation of the therapeutic choices, the patient opted for the excision of the axillary node. The anatomical pathological result showed a nodular formation compatible with fibroadenoma. The occurrence of a node in the axillary region is common. However, in the vast majority of times, it is merely an inflammatory response, manifested as a lymphadenomegaly. In case of chronic mass with suspicious characteristics, it is convenient to suspect the presence of lymphoid neoplasms, locoregional metastasis of breast cancer or melanoma and alterations in accessory breast tissue. In young patients, it is important to evaluate the existence of accessory breast tissue with the presence of suspicious axillary node, because, although controversial, some authors believe that such alterations occur more frequently in these patients. Additionally, in cases of inconclusive imaging, an excision of the lesion must be performed for a definite diagnosis.

**KEYWORDS:** fibroadenoma; breast; general surgery.

## INTRODUCTION

The mass are among the possible alterations observed in the axilla. When found, the most frequent differential diagnosis are lymphadenopathy, metastatic lymphadenomegaly, lymphoma, lipoma or tumors in the apocrine glands. Besides that, the presence of accessory breast tissue (ABT) can also be listed<sup>1-5</sup>.

The frequency of accessory breast is 5.19% in women and 1.68% in men. The most commonly affected place is the axilla (particularly its inferior portion), responding for, approximately, 60% to 70% of the cases<sup>1,2</sup>.

This anatomical variation occurs as a result of alterations in the formation of the breast tissue during the embryonic development and appears most frequently in the milk lines, which goes from the axilla until the pubic area<sup>1,3</sup>. It can be unilateral or bilateral. In most cases, its repercussion is merely aesthetic<sup>4</sup>. The conduct regarding the ABT is essentially conservative, although the surgical treatment may be reserved to those situations in which it generates physical, aesthetic or emotional alterations and the

patient shows the desire to remove it. However, the ABT, as the topical breast tissue, may become the target of breast diseases, either benign or malignant<sup>2-4</sup>.

Among the alterations that affect the topical breast tissue, the fibroadenoma is most commonly found in the premenopausal period, being a frequent cause of mass in young women, with higher incidence from 20 to 30 years old. It manifests itself as a nodular lesion, frequently unique, movable, with slow growth. At the mammography, a homogeneous, oval and confined node is observed.<sup>4</sup> However, at the ABT, it is a rarely described finding<sup>3,5</sup>.

Due to the small number of cases reported by the medical literature, we intended to report one case treated at the Mastology Department of the Universidade Federal de Juiz de Fora, Minas Gerais.

The study was approved by the Research Ethics Committee of Hospital Universitário da Universidade Federal de Juiz de Fora, under No. 090052/2019.

<sup>1</sup>Universidade Federal de Juiz de Fora – Juiz de Fora (MG), Brazil.

<sup>2</sup>Universidade Federal de Minas Gerais – Belo Horizonte (MG), Brazil.

<sup>3</sup>Faculdade de Ciências Médicas e da Saúde de Juiz de Fora – Juiz de Fora (MG), Brazil.

\*Corresponding author: miralvagc@gmail.com

Conflict of interests: nothing to declare.

Received on: 08/14/2020. Accepted on: 09/08/2020.

## CASE REPORT

Female patient at 23 years old was taken to the Mastology Service due to the emergence of a palpable node of hard consistency in the right axilla. Denies personal or family history of gynecological cancer; denies breast cancer in first-degree relatives. The patient did not present other alterations at the physical exam. An ultrasound was performed in the breasts and axilla (Figure 1), which showed a solid, irregular, heterogeneous, hypoechoic node, with indistinctive margins, with the larger axis in parallel to the skin, without post acoustic phenomenon and with central vascularization at the Doppler, in the right axilla (Figure 2). Its dimensions were 1.5 × 0.7 cm (Bi-Rads® 4). The findings above mentioned discarded the hypothesis of a possible lymphadenomegaly.

The patient was, then, submitted to a fine-needle aspiration biopsy (FNAB). The material obtained and sent for analysis was unsatisfying (fixation artifacts). After the inconclusive material, it was explained the therapeutic possibilities, as well as its risks, or even investigation possibilities of the nature of the nodule, like using ultrasound-guided core needle biopsy before an excisional biopsy. The patient opted for the excision of the axillary node. The anatomical-pathological result evidenced a nodular

formation of 1.9 × 2.0 cm, which at the microscope presented a benign and biphasic neoplasia with epithelial component constituted by ramified tubules and occasionally enlarged when at the fibroblastic stromal component, with a delicate fibrous capsule delimitating it from the adjacent breast tissue, compatible with fibroadenoma in axillary accessory breast (Figure 3).

## DISCUSSION

The occurrence of a node in the axillary region is not unusual. However, at the vast majority of cases, it is merely an inflammatory response, manifested as a lymphadenomegaly. In case of chronic mass with suspicious characteristics, such as adherence to deep plans, absence of pain, irregular surface, and stony, it is convenient to suspect the presence of lymphoid neoplasms, locoregional metastasis of breast cancer or melanoma and alterations in ABT<sup>3</sup>. In this case, an adequate investigation of differential diagnostic through biochemical exams, imaging and percutaneous biopsy is necessary, having the best conduct of the patient in mind.

The presence of ABT is well documented by the medical literature; however, the presence of benign or malign tumors in this tissue is something that has been rarely reported<sup>3,5</sup>, not allowing, therefore, conclusions regarding its most common presentation form.

Table 1 summarizes a systematic search in the literature for cases involving the topic fibroadenoma in ABT filed at the PubMed. For the conclusion of the research, the following term associations were used: “fibroadenoma” and “supernumerary breast”/“fibroadenoma” and “ectopic breast”/“fibroadenoma” and “axilla”/“fibroadenoma” and “axillary breast”. All reports of cases of fibroadenoma in ABT with a summary available were considered and used, totaling 19 articles, with 22 cases reported.



Figure 1. Ultrasonography of the right axilla.

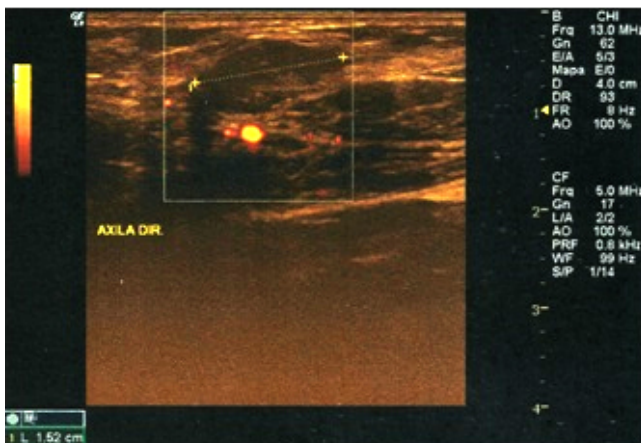

Figure 2. Ultrasonography, with Doppler effect, of the right axilla.

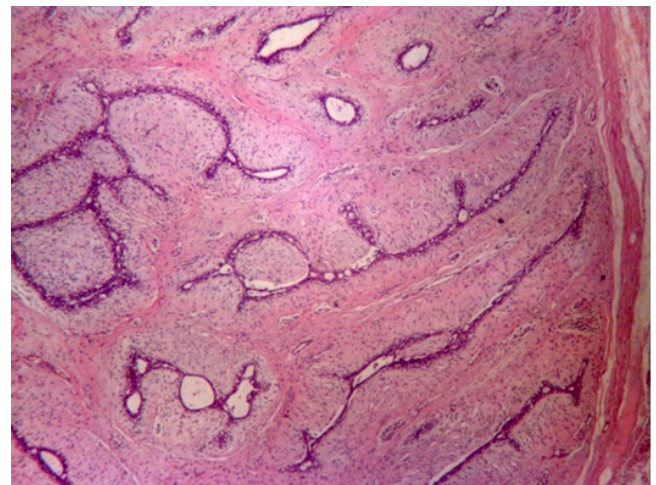

Figure 3. Benign neoplasia, biphasic, well delimited of the adjacent breast tissue through a delicate fibrous capsule. Hematoxilina-Eosina (HE) 20.

**Table 1.** Reports of cases of fibroadenoma in accessory breast tissue.

Year	Article	Patient's age	Site	Side	Size (mm)
1982	Khan et al. <sup>2</sup>	34	Below the breast	R	40
1984	Bertrand et al. <sup>6</sup>	80	Urethral-vaginal Septum	ND	20
2000	Aughsteen et al. <sup>7</sup>	28	Axilla	R	ND
2002	Baisre et al. <sup>8</sup>	29 and 42	Vulva	ND	ND
2005	Conde et al. <sup>3</sup>	39	Axilla	R	12
2005	Coras et al. <sup>9</sup>	23	Axilla	R	20 × 20
2006	Ciralik et al. <sup>10</sup>	23	Axilla	ND	ND
2007	Eroglu <sup>11</sup>	26	Below the breast	L	ND
2008	Odiye et al. <sup>12</sup>	34	Axilla	R	ND
2008	Carter et al. <sup>13</sup>	45	Vulva	ND	ND
2009	Cantú de Leon et al. <sup>14</sup>	19	Vulva	R	120 × 50
2009	Lucas et al. <sup>15</sup>	ND	Vulva	ND	ND
2010	Sawa et al. <sup>1</sup>	41	Axilla	R	38
2010	Gentile et al. <sup>16</sup>	58	Axilla	Bilateral	50 × 65 (E) 55 × 65 (D)
2011	Zhang et al. <sup>17</sup>	18	Vulva	ND	ND
2011	Senatore et al. <sup>5</sup>	21	Axilla	L	30
2012	Ortiz-Mendoza <sup>18</sup>	36 ± 9	Axilla	ND	28 ± 18
2012	Val-Bernal et al. <sup>19</sup>	29	Axilla	R	ND
2012	Dhaoui et al. <sup>20</sup>	28	Vulva	ND	30 × 30 × 20
2014	Current case	23	Axilla	R	19 × 20

ND: not documented. R: right; L: left.

The articles were dated from 1982 to 2012, and the average age of the patients involved in the researches was 33 years old (18–30 years old). In regards to the location site of the ABT found, as well as in the patient, the most affected region is the axilla, mentioned in 10 articles (from 11 cases reported). Other locations were the vulva, mentioned in 6 articles (with 7 cases reported); the region below the breast (2 cases reported); the vaginal septum (1 case reported); and the anogenital region (1 case reported). The mass, similarly to our report, were most prevalent in the right side, corresponding to 9 cases of the 12 documented. The left side was reported in 2 cases, and there was 1 case of bilateral involvement. Among the mass with a description of the size, the average identified was of 3.9 cm.

In certain cases, as in the case reported, the ABT is not clinically perceptible, making the association of an axillary node with a probable alteration of the breast parenchyma more difficult<sup>1,5</sup>.

However, at young patients, as well as in the case of the patient presented in this report, the suspicion of an ABT alteration as a result of the suspicious axillary node is very important because the accessory breast tissue, despite the controversy, may be affected by the same diseases and alterations that compromise topical breast tissue. However, due to its low incidence, diagnosis may be delayed or even ignored, thus making treatment more difficult. Then, when tumors or nodules are found

along the mammary line, the presence of breast tissue should be considered during the investigation<sup>3,5</sup>.

Against the controversy about the greater chance of malignancy of the ABT and the worse prognosis, and considering the importance of the early diagnosis of breast carcinoma, surgeons are faced with the dilemma of surgical treatment or monitoring. In our case, due to the difficulties of the clinical diagnostic of ABT and the cytological diagnostic of fibroadenoma, the excision of the node was the choice made for the diagnostic conclusion.

## CONCLUSION

Through the case report, it is possible to conclude the importance of taking into consideration the possibility of an alteration of the ABT faced with the presence of a suspicious node located in the breast line region. Additionally, in cases of inconclusive imaging and percutaneous biopsies for the diagnostic, the excision of the lesion must be performed for a definite conclusion.

## AUTHORS' CONTRIBUTIONS

B.E.P.L.: Conceptualization, funding acquisition, project administration, supervision, writing – original draft, conceptualization, data curation, formal analysis, investigation,

visualization, methodology, validation, writing – review & editing.

H.C.S.: Conceptualization, funding acquisition, project administration, supervision, writing – original draft, conceptualization, data curation, formal analysis, investigation, visualization, validation, writing – review & editing.

N.M.M.: Formal analysis, visualization, investigation, data curation, conceptualization, writing – original draft, methodology, validation, writing – review & editing.

J.M.C.R.: Conceptualization, funding acquisition, project administration, supervision, writing – original draft, conceptualization, data curation, formal analysis, investigation, visualization, validation, writing – review & editing.

M.A.G.C.: formal analysis, visualization, investigation, data curation, conceptualization, writing – original draft, methodology, validation, writing – review & editing.







S.D.E.: formal analysis, visualization, investigation, data curation, conceptualization, writing – original draft, methodology, validation, writing – review & editing.

## REFERENCES

1. Sawa M, Kawai N, Sato M, Takeuchi T, Tamaki T, Oura S. Fibroadenoma of the axillary accessory breast: diagnostic value of dynamic magnetic resonance imaging. *Jpn J Radiol.* 2010;28(8):613-7. <https://doi.org/10.1007/s11604-010-0466-5>
2. Khan T, James CR, White JE. Tumors of extramammary breast tissue. *J Natl Med Assoc.* 1982;74(1):37-8.
3. Conde DM, Torresan RZ, Kashimoto E, Carvalho LEC, Cardoso Filho C. Fibroadenoma in axillary supernumerary breast: case report. *São Paulo Med J.* 2005;123(5):253-5. <https://doi.org/10.1590/S1516-31802005000500011>
4. Tiezzi DG, Valejo FAM, Nai GA, Tiezzi MG. Linfonodo-sentinela no câncer de mama acessória: relato de caso. *Rev Bras Ginecol Obstet.* 2006;28(1):50-3. <https://doi.org/10.1590/S0100-72032006000100009>
5. Senatore G, Zanotti S, Cambrini P, Montroni I, Pellegrini A, Montanari E, et al. Ectopic breast fibroadenoma. Case report. *G Chir.* 2010;31(3):96-9.
6. Bertrand G, Deroide JP, Bidabe MC. Fibroadenoma of the paraurethral glands. A new tumoral entity? *Ann Pathol.* 1984;4(2):147-50.
7. Aughsteen AA, Almasad JK, Al-Muhtaseb MH. Fibroadenoma of the supernumerary breast of the axilla. *Saudi Med J.* 2000;21(6):587-9.
8. Baisre A, Heller DS, Lee J, Zheng P. Fibroadenoma of the vulva. A report of two cases. *J Reprod Med.* 2002;47(11):949-51.
9. Coras B, Landthaler M, Hofstaedter F, Meisel C, Hohenleutner U. Fibroadenoma of the axilla. *Dermatol Surg.* 2005;31(9 Pt 1):1152-4. <https://doi.org/10.1097/00042728-200509000-00015>
10. Ciralik H, Bulbuloglu E, Arican O, Cital R. Fibroadenoma of the ectopic breast of the axilla: a case report. *Pol J Pathol.* 2006;57(4):209-11.
11. Eroglu A. Fibroadenoma in supernumerary breast. *J BUON.* 2007;12(2):285-6.
12. Odike MA, Orakwe JC, Oguejiofor OC, Odenigbo UC, Onyiaorah IV. Axillary fibroadenoma mimicking lymphadenopathy. *Niger J Clin Pract.* 2008;11(1):72-3.
13. Carter JE, Mizell KN, Tucker JA. Mammary-type fibroepithelial neoplasms of the vulva: a case report and review of the literature. *J Cutan Pathol.* 2008;35(2):246-9. <https://doi.org/10.1111/j.1600-0560.2007.00796.x>
14. Cantú de Leon D, Perez Montiel D, Vázquez H, Hernández C, Cetina L, Lucio MH. Vulvar fibroadenoma: a common neoplasm in an uncommon site. *World J Surg Oncol.* 2009;7:70. <https://dx.doi.org/10.1186%2F1477-7819-7-70>
15. Lucas EW Jr., Branton P, Mecklenburg FE, Moawad GN. Ectopic breast fibroadenoma of the vulva. *Obstet Gynecol.* 2009;114(2 Pt 2):460-2. <https://doi.org/10.1097/aog.0b013e3181af672d>
16. Gentile P, Izzo V, Cervelli V. Fibroadenoma in the bilateral accessory axillary breast. *Aesthetic Plast Surg.* 2010;34(5):657-9. <https://doi.org/10.1007/s00266-010-9505-y>
17. Zhang J, Chen Y, Wang K, Xi M, Yang K, Liu H. Prepubertal vulval fibroma with a coincidental ectopic breast fibroadenoma: report of an unusual case with literature review. *J Obstet Gynaecol Res.* 2011;37(11):1720-5. <https://doi.org/10.1111/j.1447-0756.2011.01580.x>
18. Ortiz-Mendoza CM. Axillary ectopic breast tissue fibroadenoma: report of three cases and review of the literature. *Ginecol Obstet Mex.* 2012;80(2):99-103.
19. Val-Bernal JF, González-Vela MC, De Grado M, Garijo MF. Sclerotic fibroma (storiform collagenoma)-like stroma in a fibroadenoma of axillary accessory breast tissue. *J Cutan Pathol.* 2012;39(8):798-802. <https://doi.org/10.1111/j.1600-0560.2012.01940.x>
20. Dhaoui A, Nfoussi H, Kchir N, Haouet S. Vulvar lactating adenoma associated to a fibroadenoma: common neoplasms in an uncommon site. *Pan Afr Med J.* 2012;13:47.



# Bilateral risk-reducing mastectomy in a patient over 50 years of age: case report with an emphasis on the psychological aspect in the face of serious complications

Rafael Everton Assunção Ribeiro da Costa<sup>1\*</sup> , João Victor Caminha Lustosa Falcão<sup>2</sup> , Liana Carrias Bruno<sup>2</sup> , Marianne Magalhães Fortes<sup>2</sup> , Ana Lúcia Nascimento Araújo<sup>3</sup> , Sabas Carlos Vieira<sup>4</sup> 

## ABSTRACT

Malignant breast neoplasia is the main cause of cancer mortality in women in Brazil, after non-melanoma skin cancer, and about 5 to 10% of these cases are associated with family inheritance; BRCA1 and BRCA2 genes are the most frequently mutated. In this sense, there has been a paradigm shift in medical practice regarding breast cancers in recent years, with the implementation of risk-reducing surgical procedures, such as bilateral mastectomy and salpingo-oophorectomy, which still have controversies in the indication, in addition to fears and sufferings of patients, before and after the procedure. A 54-year-old female patient has been undergoing routine examinations since 2009 (49 years), as she has a family history of breast cancer. In May 2014 (54 years old), the patient underwent genetic research, discovering the pathogenic 648delT mutation in heterozygosity in the BRCA1 gene. Although complementary exams did not indicate any neoplasia, the patient wanted to undergo risk-reducing surgery. After interprofessional discussion with the patient, bilateral risk-reducing mastectomy and salpingo-oophorectomy were performed. The patient had a postoperative infection, and one of the silicone prostheses was removed from her breast. In 2015 (55 years old), she underwent a new prosthesis inclusion, evolving without complications. Currently, she is being followed up and without evidence of active cancer disease. Despite the complication with the prosthesis, there was an improvement in psychological aspects that bothered her, referring to a reduction in anxiety and fear of cancer. Although beneficial, risk-reducing mastectomy has associated risks, especially in patients with advanced age and comorbidities. However, with an appropriate approach and focused on the complexities of each person, it is possible to provide the patient with a better overall psychological experience, as demonstrated in this case reported.

**KEYWORDS:** Mutation; Genes, BRCA1; Breast neoplasms; Prophylactic mastectomy; Salpingo-oophorectomy; Middle aged.

## INTRODUCTION

According to data from the National Cancer Institute José Alencar Gomes da Silva (*Instituto Nacional de Câncer José Alencar Gomes da Silva* – INCA), malignant breast neoplasms are the main cause of cancer mortality among women in Brazil, after non-melanoma skin cancer.<sup>1</sup> Estimates show that from 5% to 10% of breast cancer cases are hereditary, and in these cases, they appear at an early age, in a bilateral way and affecting several generations.<sup>2</sup>

Mutations in the BRCA1 and BRCA2 genes represent about 20% of cases of hereditary breast cancer, which can lead to a

cumulative risk of developing the disease of about 50% to 80%.<sup>2</sup> As a result, risk-reducing surgeries are proposed for patients with pathogenic mutations in high penetration genes (BRCA, TP53, CHECK2, PALB2, PTEN) around 35–40 and 40–45 years old, in individuals with BRCA1 and BRCA2 mutations, respectively.<sup>3,4</sup>

Surgical risk reduction procedures, especially bilateral mastectomy, have a great impact on patients' psychological aspects because they involve organs associated with sexuality, self-esteem, and self-perception of women's self-image.<sup>5,6</sup> Therefore, considering the psychological aspects involved in these procedures is

<sup>1</sup>Universidade Estadual do Piauí – Teresina (PI), Brazil.

<sup>2</sup>Centro Universitário Uninovafapi – Teresina (PI), Brazil.

<sup>3</sup>Hospital São Marcos – Teresina (PI), Brazil.

<sup>4</sup>Tocoginecologia, Oncocenter – Teresina (PI), Brazil.

\*Corresponding author: [rafaelearcosta@gmail.com](mailto:rafaelearcosta@gmail.com)

Conflict of interests: nothing to declare.

Received on: 09/02/2020. Accepted on: 09/22/2020



essential, and considering the complexity of each patient is also important, which makes interprofessionality necessary when approaching of these cases.<sup>5,6</sup>

Given the importance of malignant breast neoplasms in the context of women's health and, more recently, the paradigm changes in the care model to patients with a family history of breast cancer, especially those germinative mutations of high penetration, we report a case of risk-reducing mastectomy in a patient over 50 years of age with a mutation in the BRCA1 gene that presented postoperative complications, and we evaluated the possible psychological impacts of surgery and complications for her quality of life.

## CASE REPORT

A 54-year-old female patient has been undergoing routine examinations since 2009 (49 years old), as she has a family history of breast cancer: a sister who died at 52, and another sister who was diagnosed with the disease at 50, as well as their mother, who died at the age of 55, two maternal aunts, and two maternal cousins (one died under 50, and the other was diagnosed with breast cancer at 32), as well as a niece diagnosed at 34 (Figure 1).

In May 2014 (54 years old), the patient undertook genetic research for a specific BRCA1 mutation present in the family, and the pathogenic 648delT mutation was detected in heterozygosis. Breast MRI was normal. The possibility of bilateral mastectomy

and risk-reducing salpingo-oophorectomy was discussed with the patient on several occasions. She was afraid of developing breast cancer and dying due to her family history, because several members of her family died due to disease progression in the productive phase of life. The patient had difficulties in understanding the surgeries and surgical risks involved, as well as the low impact on reducing mortality in patients over 50 years of age.

The patient had the option of using chemoprophylaxis with tamoxifen for five years, annual follow-up with breast MRI, and mammography and transvaginal ultrasound and semiannual CA 125, highlighting the fact that there is no evidence of reduced mortality from ovarian cancer by screening with transvaginal ultrasound and CA 125.<sup>7</sup>

The patient was referred to psychotherapy because she was very confused. She was not sure how much the risk of developing breast cancer would be reduced with prophylactic surgery, besides the fact that her health insurance not having authorized the procedures. After extensive discussion with the patient, her family and psychologist, a decision was made to reduce the risk of breast and ovarian cancer after informed consent.

Bilateral mastectomy and risk-reducing salpingo-oophorectomy were performed, and breast reconstruction with the inclusion of a bilateral subpectoral prosthesis was also carried out. On the 14<sup>th</sup> postoperative day, the surgical wound showed necrosis of the lower part of the complete right papillary artery, and debridement was performed. On the 35<sup>th</sup> postoperative day, the patient

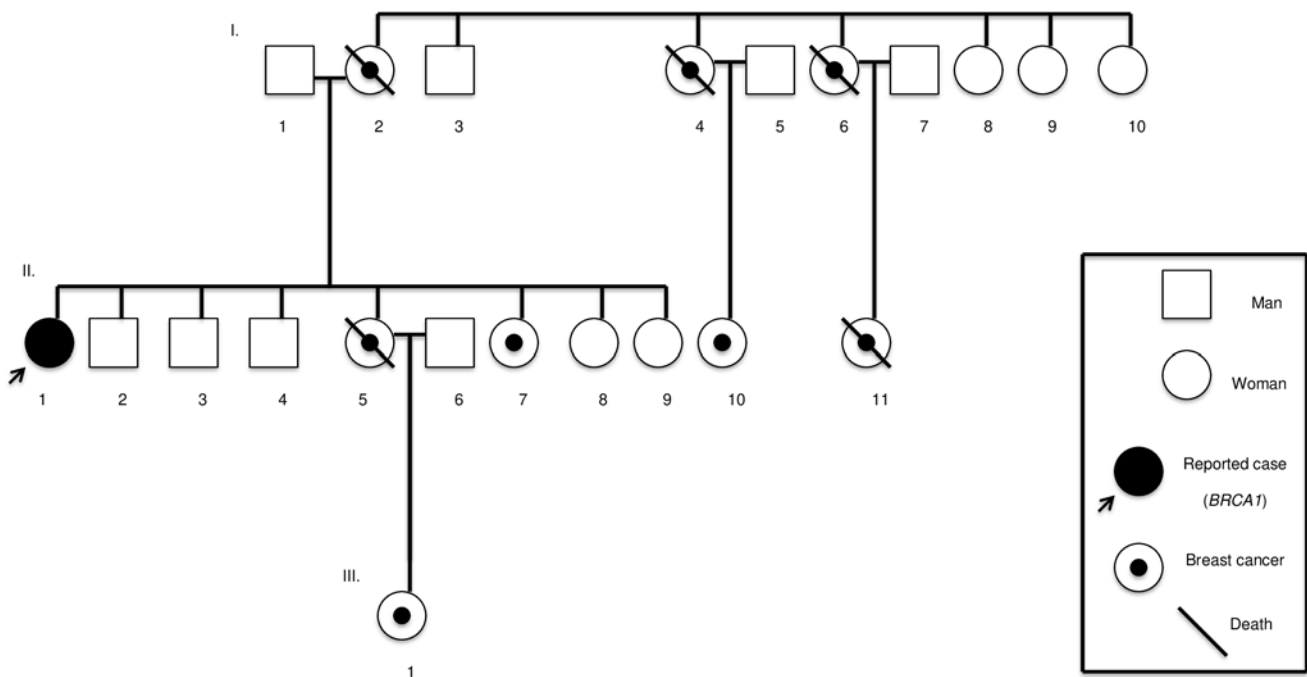

**Figure 1.** Heredogram of the family history of breast cancer in the reported case of a BRCA1 patient over 50 years of age who underwent bilateral risk-reducing mastectomy.



**Figure 2.** Final aspect of bilateral risk-reducing mastectomy with complications in a patient over 50 years of age. (A) Front view; (B) right side view; (C) left side view.

had dehiscence at angles of the submammary fold and necrosis of the papillae, and debridement was performed, but without prosthesis exposure and without seroma. On the 67<sup>th</sup> postoperative day, the right prosthesis was removed due to infection and the material was sent for culture, growing *Streptococcus agalactiae*. Since then, it has evolved well with surgical site healing.

Histological examination with specific protocol with serial cuts of the specimens of the breast, ovaries, and tubes did not detect any neoplasia.

In 2015 (55 years old), the patient underwent a new breast implant on her right breast, evolving without complications. Currently, she is being followed up and presents no evidence of active cancer disease (Figure 2). The patient, despite the complication with the prosthesis, showed improvement in psychological aspects that bothered her, referring to reduced anxiety and fear of developing cancer.

The study protocol was approved by the Research Ethics Committee (CEP) of Universidade Federal do Piauí (UFPI), Teresina City, Piauí State, Brazil, under CAAE No. 94518518.9.0000.5214, which includes the study of patients with breast cancer. The precepts contained in the resolution of the National Health Council No. 466/12 were observed.

## DISCUSSION

Monteiro et al. pointed out in their study that, among women undergoing risk-reducing mastectomy, 30% have postoperative complications, such as bruising, infection and implant rupture, and 49% regret having the procedure performed.<sup>8</sup>

In the present study, the patient had complications, requiring the removal of the prosthesis and posterior surgery to place another prosthesis on her right breast. Despite these significant complications, she reported improvement in psychological aspects that bothered her, referring to less anxiety and fear of death from breast cancer. Therefore, a well-prepared preoperative discussion, which considers all dimensions of human nature, can be a key element for improving well-being and quality of life after risk-reducing bilateral mastectomy, even when there are complications, just like in the case reported, also affecting the general motivation in relation to the procedure.

Comorbidities that may increase the risk of complications, such as significant heart or lung disease, obesity, diabetes, smoking, steroid use, or chronic anticoagulation<sup>9</sup> should also be considered upon surgery indication of surgery. The occurrence of these complications is due to vascular microlesions, either due to trauma during the handling of the skin flap of the breast envelope, or due to the patient's intrinsic conditions.<sup>9</sup> In the present case, the patient did not present comorbidities.

Bilateral prophylactic mastectomy reduces the risk of developing breast cancer by about 90% to 95% in carriers of mutations in the BRCA10 genes. In addition to reducing the incidence of

malignant breast neoplasms, prophylactic procedures are associated with improving psychological aspects, such as reducing the fear of developing cancer and dying early, which is common in women with a family history.<sup>10</sup>

In a previous study by Giannakeas and Narod, they pointed out that the chances of being alive at the age of 80 after a mastectomy procedure at the age of 25 increased by 8.7% (from 42.7% to 51.3%). However, the estimated benefit when surgery is performed at 50 years of age is very small (2.8% at 80 years; from 42.7% to 45.5%).<sup>11</sup> Bilateral risk-reducing salpingo-oophorectomy alone decreases mortality from breast and ovarian cancer, in addition to decreasing the risk of breast cancer by 50% when performed before the age of 50. Therefore, such procedure must be discussed with these patients.<sup>3,4</sup> The patient in the present case did not accept performing only salpingo-oophorectomy.

Even with a small survival benefit, the patient's quality of life must be considered. The fact that these women with pathogenic mutations who have not yet developed cancer have seen suffering and deaths in close family members due to breast cancer sometimes leads to intense suffering. Risk-reducing surgeries should only be performed after extensive discussion with a multidisciplinary team and effective patient participation, clarifying all the complications involved, including the aesthetic sequelae, often irreparable. In the present case, even in the face

of a serious complication, the patient accepted it well and has a good quality of life.

## CONCLUSION

Although beneficial, risk-reducing mastectomy, like any surgery, presents associated risks, especially in old age and in the presence of comorbidities. However, with an appropriate approach and focused on the complexities of each individual, providing the patient with a better overall psychological experience is possible, with improved perception of anxiety and decreased fear of falling ill and dying early, just like demonstrated in the case reported.

## AUTHORS' CONTRIBUTION

R.E.A.R.C.: study concept, data curation, formal analysis, methodology, project management, writing – original draft, writing – review & editing.

J.V.C.L.F.: study concept, data curation, formal analysis, methodology, project management, writing – original draft.

L.C.B.: data curation, research, methodology.

M.M.F.: data curation, research, methodology.

A.L.N.A.: formal analysis, methodology.





S.C.V.: formal analysis, methodology, writing – review & editing.

## REFERENCES

1. Brazil. Ministério da Saúde. Instituto Nacional de Câncer José Alencar Gomes da Silva (INCA). Coordenação de Prevenção e Vigilância. Estimativa 2020: incidência de câncer no Brasil [Internet]. Rio de Janeiro: Ministério da Saúde; 2019 [accessed on Mar 16, 2020]. Available on: <https://www.inca.gov.br/sites/ufu.sti.inca.local/files/media/document/estimativa-2020-incidencia-de-cancer-no-brasil.pdf>
2. Amendola LCB, Vieira R. A contribuição dos genes BRCA na predisposição hereditária ao câncer de mama. *Rev Bras Cancerol.* 2005;51(4):325-30.
3. Coelho AS, Santos MAS, Caetano RI, Piovesan CF, Fiuza LA, Machado RLD, et al. Predisposição hereditária ao câncer de mama e sua relação com os genes BRCA1 e BRCA2: revisão da literatura. *RBAC.* 2018;50(1):17-21. <http://doi.org/10.21877/2448-3877.201800615>
4. Cabello C. Histerectomia durante a salpingooforectomia redutora de risco em mulheres com mutações deletérias nos genes brca1 ou brca2. Indicar ou não? *Rev Bras Mastologia.* 2017;27(1):1-2. <http://doi.org/10.5327/Z201700010001RBM>
5. Almeida RA. Impacto da mastectomia na vida da mulher. *Rev SBPH.* 2006;9(2):99-113.
6. Cesnik VM, Santos MA. Mastectomia e sexualidade: uma revisão integrativa. *Psicol Reflex Crit.* 2012;25(2):339-49. <https://doi.org/10.1590/S0102-79722012000200016>
7. Rebbeck TR, Friebel T, Lynch HT, Neuhausen SL, Van't Veer L, Garber JE, et al. Bilateral prophylactic mastectomy reduces breast cancer risk in BRCA1 and BRCA2 mutation carriers: the PROSE Study Group. *J Clin Oncol.* 2004;22(6):1055-62. <https://doi.org/10.1200/jco.2004.04.188>
8. Monteiro GA, Novaes JR, Carvalho Júnior JD, Rio JA, Ribeiro LLS, Silva LP, et al. O dilema da decisão de Mastectomia Bilateral como prevenção do Câncer de Mama: aspectos éticos e bioéticos. *Revista Bioethikos - Centro Universitário São Camilo.* 2011;5(4):443-50.
9. Cowen D, Gross E, Rouannet P, Teissier E, Ellis S, Resbeut M, et al. Immediate post-mastectomy breast reconstruction followed by radiotherapy: risk factors for complications. *Breast Cancer Res Treat.* 2010;121(3):627-34. <https://doi.org/10.1007/s10549-010-0791-5>
10. Ludwig KK, Neuner J, Butler A, Geurts JL, Kong AL. Risk reduction and survival benefit of prophylactic surgery in BRCA mutation carriers, a systematic review. *The Am J Surg.* 2016;212(4):660-9. <https://doi.org/10.1016/j.amjsurg.2016.06.010>
11. Giannakeas V, Narod SA. The expected benefit of preventive mastectomy on breast cancer incidence and mortality in BRCA mutation carriers, by age at mastectomy. *Breast Cancer Res Treat.* 2018;167(1):263-7. <https://doi.org/10.1007/s10549-017-4476-1>



# Bilateral axillary lymphadenopathy: differential diagnosis and management

Paula Clarke<sup>1\*</sup> , Carolina Nazareth Valadares<sup>1</sup> , Débora Balabram<sup>1,2</sup> , Douglas de Miranda Pires<sup>1</sup> 

## ABSTRACT

Lymphonodopathy is an increase in volume and/or changes in the characteristics of lymph nodes, and it can be caused by benign or malignant diseases. Appropriate physical examination should define their clinical characteristics, and, if needed, complementary imaging or anatomopathological tests should be performed for diagnostic definition. In the present article, we report the case of a female patient, with sarcoidosis, who presented axillary lymph node disease, and the exams that followed until the diagnostic conclusion.

**KEYWORDS:** sarcoidosis; lymphadenopathy; lymph nodes; breast diseases; tuberculosis, lymph node.

## INTRODUCTION

Axillary lymphadenopathy is characterized by an increase in volume or changes in lymph node morphology.<sup>1</sup> It can be detected with palpation on physical examination or alteration in imaging tests. Normal lymph nodes on a mammogram (MMG) are usually oval or reniform and have a radiolucent center, representing hilar fat. On ultrasound (US) imaging, the cortex is usually hypoechoic or even imperceptible, and the medulla is hyperechoic. Once compromised, either by benign or malignant diseases, the lymph node changes its shape and structure, showing different patterns in imaging tests.<sup>2,3</sup>

The most common causes of axillary lymphadenopathies are: carcinomas; lymphomas; benign reactive hyperplasia; non-granulomatous infections, such as those caused by the human immunodeficiency virus, syphilis, and hepatitis; granulomatous diseases, infectious or not, such as: sarcoidosis, toxoplasmosis, tuberculosis, atypical mycobacterioses, cat-scratch disease; and autoimmune or rheumatological diseases, such as lupus, rheumatoid arthritis, scleroderma, among others.<sup>3-5</sup>

The objective of the present study was to report a case of a patient attended at the Mastology outpatient clinic of Santa Casa in Belo Horizonte City, Minas Gerais State, who presented with bilateral axillary lymphadenopathy and had a final diagnosis of a rare disease, sarcoidosis. In the discussion, we present the main causes of axillary lymphadenopathy, the bases for its

investigation, as well as histological aspects and clinical information on the most frequent differential diagnoses.

## CASE REPORT

This is a case report of a patient attended at the Medical Specialties Center of Santa Casa de Belo Horizonte (SCBH). A bibliographic review was carried out on the PubMed database using the descriptors “axilla”, “lymphadenopathy”, “granulomatous lymphadenitis”, “breast sarcoidosis”, “sarcoidosis” and “occult breast cancer”. The articles were sorted by the abstract and those with information on the epidemiology of axillary lymphadenopathy, description of its causative diseases, diagnostic methods, treatment, and differential diagnosis were selected for full reading. Articles that were not written in English were excluded. Reference books on breast diseases were also used.

The case in question is a female patient, 51 years old, who was being followed at the Mastology Service of SCBH after excision of a complex fibroadenoma in her left breast in 2016. In May 2019, she was referred by the Pneumology Service of Hospital Júlia Kubitschek (HJK), Minas Gerais State, for the evaluation of axillary lymphadenopathy, which had developed about six months earlier. There were no changes in the physical examination of her breasts. Upon examination of the underarms, enlarged but mobile and fibroelastic lymph nodes were palpable.

<sup>1</sup>Santa Casa de Belo Horizonte – Belo Horizonte (MG), Brazil.

<sup>2</sup>Surgery Department, Faculdade de Medicina, Universidade Federal de Minas Gerais – Belo Horizonte (MG), Brazil.

\*Corresponding author: drapaulaclarke@gmail.com

Conflict of interests: nothing to declare.

Received on: 06/11/2019. Accepted on: 09/08/2020

Follow-up at the Pneumology Service began in 2017 due to a mediastinal mass, which was biopsied with mediastinoscopy, and histology confirmed the diagnosis of sarcoidosis. The patient denied other comorbidities and, when inquired about family history, she reported a sister diagnosed with breast cancer at 40 yearsold.

Given that the patient had started the investigation at HJK, she came to the Mastology Service of SCBH with a breast US performed on April 25, 2019 (Figure 1), in which enlarged lymph nodes were seen in both underarms, with cortical thickening and displacement of the fatty hilum to the periphery (thus, the nodes were considered atypical). The largest one measured  $42.7 \times 20.8 \times 21.8$  millimeters (mm) on the left axilla and  $41.9 \times 13.8 \times 25.2$  mm on the right axilla. No solid or cystic nodules were identified in the breasts, and the test was classified as category 4 by the lexicon of the Breast Imaging Reporting and Data System (BI-RADS).<sup>6</sup> A MMG was performed on May 30, 2019 (Figure 2), in which the breasts were classified as heterogeneously dense; no breast lesions were identified, but the presence of bilateral axillary nodules with increased size and density were found — category 0, according to the BI-RADS classification.<sup>6</sup>

The patient was referred with a report of negative serologies for infectious diseases and, considering her personal history of sarcoidosis, the most likely etiological hypothesis for axillary lymphadenopathy was this benign disease. Magnetic resonance

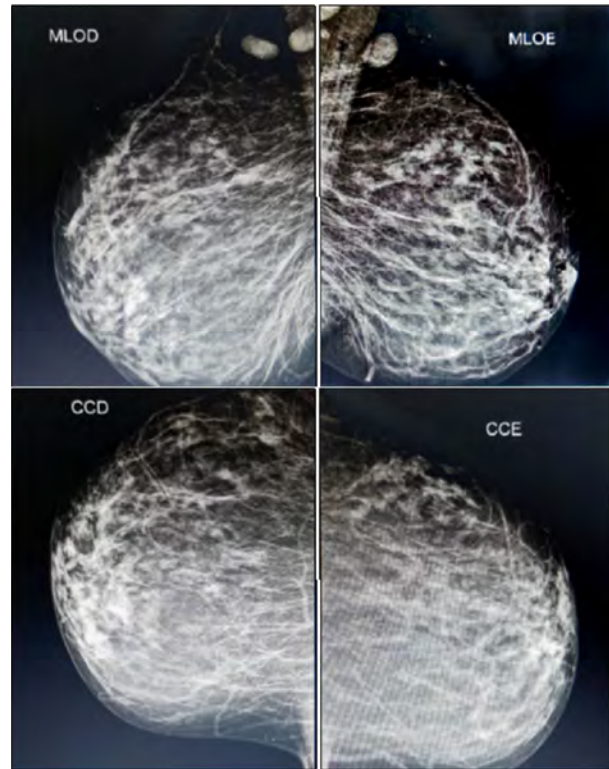

**Figure 2.** Mammogram from May 30<sup>th</sup>, 2019. Left and right oblique mediolateral view. Heterogeneously dense breasts. Bilateral axillary nodules with increased size and density. Category 0 (BI-RADS).

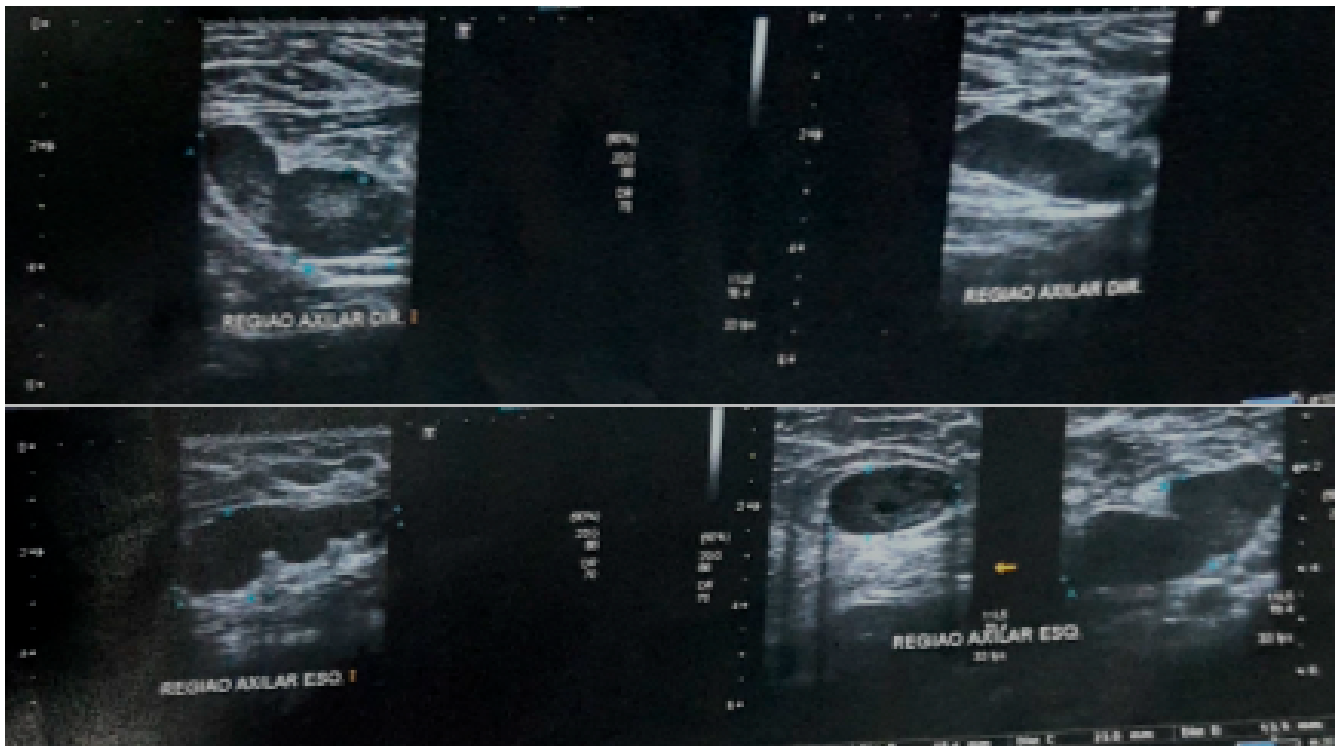

**Figure 1.** Right (upper) and left (lower) axillary ultrasound performed on April 25, 2019. Lymph nodes increased in size are seen bilaterally, with thickening of the cortex and displacement of the fatty hilum to the periphery. Category 4 (BI-RADS).

imaging (MRI) of the breasts could have been requested to assess the presence of occult breast carcinoma, especially in the context of a patient with increased risk (positive family history), but due to the difficulty of accessing this exam in the Brazilian Unified Health System (*Sistema Único de Saúde* – SUS), it was not requested. The decision was made to obtain a histological sample of the nodes with a bilateral core biopsy (fragment biopsy with a thick needle) guided by ultrasound imaging. In September 2019, the patient returned with a histological result compatible with granulomatous lymphadenitis on her left and right axillas. In the clinical context, this result corroborated the diagnosis of sarcoidosis affecting peripheral lymph nodes and allowed the medical team to safely rule out an overlapping malignancy.

The patient was then referred back to the Pneumology Service, and currently does not undergo any treatment since she is oligosymptomatic.

## DISCUSSION

### Causes of axillary lymphadenopathy

When facing axillary lymphadenopathy, several causes must be considered as differential diagnoses. In a retrospective study by the University of Southern California, evaluating 925 patients who underwent lymph node biopsies from 1973 to 1977, 60% of the lymph nodes had benign lesions, 28% had carcinomas, and 12% had lymphomas. For peripheral nodal biopsies (cervical, axillary, inguinal) 56% were related to benign lesions; 29% to carcinomas; and 15% to lymphomas. Considering only the axillary lymph nodes, 60% had benign hyperplastic, granulomatous, or adenitis. Twenty-three percent had lymphoma as a cause, and carcinomas were responsible for 18% of the cases. Statistically, age is the most important factor in estimating the likelihood of whether lymphadenopathy is due to a benign or malignant process – the older the age, the greater the risk of malignancy.<sup>1</sup>

In a retrospective study at the Medical School of Ribeirão Preto City, São Paulo State (Brazil), 54% of axillary tumors were of malignant origin, including lymphoma, breast carcinoma, or contralateral breast carcinoma metastasis, as well as other sites such as thyroid, ovaries, and stomach. The remaining 45% were secondary to benign inflammatory, reactive causes, or even ectopic breast tissue and lipoma.<sup>7</sup>

The most common causes of axillary lymphadenopathies are described in Table 1. They are: carcinomas; lymphomas; benign reactive hyperplasias; non-infectious granulomatous diseases, such as sarcoidosis; granulomatous infectious diseases, such as toxoplasmosis, tuberculosis, and cat-scratch disease; non-granulomatous infectious diseases such as the human immunodeficiency virus (HIV) and syphilis; and autoimmune or rheumatological conditions, such as lupus, rheumatoid arthritis,

**Table 1.** Causes of axillary lymphadenopathy.

Benign reactive hyperplasias
Carcinomas
Lymphomas
Infectious granulomatous diseases
Toxoplasmosis
Tuberculosis
Cat-scratch disease
Non-infectious granulomatous disease
Sarcoidosis
Non-granulomatous infectious diseases
Human immunodeficiency virus (HIV)
Syphilis
Autoimmune
Rheumatological
Lupus
Rheumatoid arthritis
Scleroderma
Others

scleroderma; among others.<sup>4,3</sup> Treatment will vary according to the cause, and may involve surgery, antibiotic therapy, chemotherapy, or even clinical observation.<sup>8</sup>

### Investigation

When a patient presents with lymphadenopathy a good anamnesis should be done in order to identify associated symptoms, signs of systemic or localized disease, and epidemiological information that may suggest its etiology. Age is also an important factor, as the chance of malignancy increases in patients over 40 years of age.<sup>9</sup>

On physical examination, the consistency of lymph nodes and whether they are matted to each other or to deep planes should be assessed. Palpating other lymph node chains to define if the involvement is localized or generalized (affecting two or more non-contiguous lymph node chains) is also important. Recent travels, contact with animals, as well as the presence of symptoms of autoimmune diseases should be evaluated.<sup>1,10</sup>

Complete blood count, serologies, chest X-rays, and other specific tests must be requested according to each suspected diagnosis. In axillary lymphadenopathy specifically, MMG and US of breasts and axillae must be used to study the breasts, in addition to assessing the lymph nodes.<sup>8</sup>

With MMG, lymph nodes can be seen in the mediolateral oblique incidence (MLO) and, when normal, they are typically small, oval, kidney-shaped or lobulated, with a radiolucent center representing the hilar fat. Although there is no consensus on the size, in general, those up to 2 cm are considered normal. Round, high-density lymph nodes, with no hilar fat, irregular, ill-defined or spiculated margins, and the presence of calcifications are considered abnormal.<sup>2,11,12</sup> Some lymph nodes can be “pushed” out of the image field

during compression in the MLO view, allowing only partial viewing. The axillary tangential view allows the assessment of underarm abnormalities which are not well characterized in standard views.<sup>2,13</sup>

Axillary US is the best imaging method to assess lymph nodes, with a sensitivity of 56 to 72%, and specificity of 70 to 90% for malignancy. At US, normal lymph nodes are elliptical, with a thin or even imperceptible hypoechoic cortex and an echogenic hilum. This method also allows the assessment of vascularization, which usually has a hilar pattern. When affected by diseases, these characteristics can be lost, and the lymph nodes tend to become more rounded, with thickening of the cortex greater than 3.0 mm, decreased fatty hilum or even absence of it. A peripheral and transcapsular flow seen on Doppler favors the suspicion of malignancy.<sup>2,3,13,14</sup>

## Pathology

In cases in which the clinical history associated with complementary exams is not able to define the etiology, the altered lymph nodes must be sampled for safe diagnosis with fine needle aspiration (FNA) or core biopsy. A meta-analysis by Houssami et al. reported a sensitivity of 72.2 and 83.3%, respectively, for FNA and core biopsy, to detect malignancy. This difference was not statistically significant in agreement with the findings of a prospective study that compared the effectiveness of both methods, guided by ultrasound.<sup>15</sup>

Technically, FNA is easier to perform and has a lower cost, but it is essential to obtain a representative quantity of non-bloody aspirate, in order to allow for an adequate interpretation of cytology, which must be performed by an experienced cytopathologist. FNA is adequate to diagnose reactive hyperplasia, granulomatous lymphadenopathies, and the presence of carcinoma metastases.<sup>16</sup> One of the most important limitations of FNA is the high false negative rate for Hodgkin's lymphoma (HL). Besides that, it does not allow for a differentiation of the subtypes of non-Hodgkin lymphomas (NHL).<sup>17</sup>

Cytology with histiocyte aggregates, which may or may not contain multinucleated giant cells, favors the diagnosis of granuloma. The presence of a necrotic background suggests caseous granuloma and, possibly, tuberculosis or other mycobacterioses. Cytological findings should be associated with clinical history and other diagnostic tests, for example, culture for mycobacteria on suspicion of tuberculosis, IgG and IgM serology on suspicion of toxoplasmosis, and chest X-rays to search for signs compatible with sarcoidosis or tuberculosis.<sup>17</sup>

Core biopsy provides a greater amount of material, allowing histological study. It should be preferred if the nodule is well visualized and easily accessible.<sup>15,16</sup> In case of suspected lymphoma, core-biopsy can be performed, but ideally, complete excision of the lymph node allows for adequate assessment, diagnosis, and classification of the disease.<sup>18</sup>

Histologically, *Mycobacterium TB* produces specific chronic granulomatous inflammation with giant Langerhans cells, caseous necrosis and calcifications. Satellite microabscesses surrounding the central necrosis area can be seen in cat-scratch disease. Non-necrotizing epithelioid granulomas with multinucleated giant cells are a characteristic feature of sarcoidosis.<sup>17</sup>

Reed-Sternberg cells present in a background of polymorphonuclear inflammatory cells are characteristically observed in HL.<sup>17</sup> In NHL, morphology and the lymph node architecture are important to define the disease's subtype, thus justifying its complete excision. Immunohistochemistry also plays a fundamental role in the subclassification of the various forms of NHL, which occurs according to their derivation from B or T lymphocytes, or natural killer cells.<sup>19</sup>

## Sarcoidosis

Sarcoidosis is a rare systemic granulomatous disease of obscure etiology. Most often, it affects lungs and intrathoracic lymph nodes, but it can affect any body organ, including peripheral lymph nodes. In 80% of cases, it affects adults between 20 and 50 years of age, and in up to 10% of cases there is a positive family history of the disease.<sup>14</sup>

The diagnosis of sarcoidosis should be suspected in middle-aged adults, with unexplained cough, dyspnea, and systemic symptoms. Nonspecific symptoms, such as fever, myalgia, and arthralgia may be associated. Extrapulmonary manifestations are most often found in the spleen (splenomegaly), in the eyes (uveitis, vascular changes in the retina, nodules in the conjunctiva, enlargement of the lacrimal gland), in the skin (papules, nodules, plaques, erythema nodosum), and in the peripheral lymph nodes (most often cervical and supraclavicular). Approximately 50% of patients are asymptomatic. The acute appearance of erythema nodosum, associated with bilateral hilar lymphadenopathy, fever, polyarthrititis, and uveitis, is called Löfgren syndrome, and is typical of sarcoidosis.<sup>20-22</sup>

The diagnosis of sarcoidosis comprises three criteria:

- compatible clinical and radiological presentation;
- pathological evidence of non-necrotizing granulomas;
- exclusion of other diseases with similar presentation.<sup>14</sup>

Chest radiography is the basic exam to stage the disease, and computed tomography should be reserved for suspected cases of complications, such as pulmonary fibrosis, bronchiectasis, infection, or malignancy.<sup>20-22</sup>

Spontaneous remission can occur in up to two thirds of cases, and is more common in the first years of the disease. Another 10 to 30% of patients evolve to a chronic and progressive course, which can be characterized by cough, exertional dyspnea, arthralgia, night sweats, weight loss, and fatigue.<sup>20,21</sup>

Corticosteroid therapy should be indicated for more advanced, progressive disease, or those cases with an important extrapulmonary manifestation, for a minimum course of 12 months. Recurrence after interrupting treatment is not uncommon and occurs more frequently from two to six months after discontinuation of the drug, being rare after three years of corticosteroid suspension. Other agents such as methotrexate and azathioprine can be used.<sup>14,21</sup>

In some cases of severe and progressive disease, lung transplantation may be indicated.<sup>21</sup> In our review, no indication for surgical excision of the affected lymph nodes was found.

### Tuberculous lymphadenitis

Tuberculous lymphadenitis is one of the forms of extrapulmonary manifestation of tuberculosis, with a peak between 30 and 40 years of age, affecting more women than men, in a 1.4:1 ratio.

Patients have a history of lymph node enlargement in a single chain, usually cervical, with an evolution of one to two months. Systemic symptoms are more common when concomitant infection with the HIV is present.<sup>23</sup>

Some diagnostic tests can be useful to raise the suspicion of tuberculous lymphadenitis such as the tuberculin skin test (TST), and the interferon-gamma release (IGRA) tests. In Brazil, the available IGRA test is QuantiFERON®-TB, which quantifies, with an immuno-enzymatic assay (ELISA), the levels of interferon-gamma released by memory T cells after stimulation of the whole blood with specific antigens of *M. tuberculosis*.<sup>23-25</sup>

The TST's specificity is 97%. False positive reactions can occur in individuals infected with other mycobacteria or vaccinated with BCG (*Bacillus Calmette-Guérin*), especially if vaccinated or revaccinated after the first year of life. TST's sensitivity is 77%, and false negative results can occur if poorly conserved tuberculin is used, if the patient has an altered immune response, in the presence of other acute viral, bacterial or fungal infections, among other causes.<sup>23,24</sup>

The disadvantages of TST are the need for direct application to the patient, it requires a second visit to read the result, it is examiner dependent, and, mainly, the number of false positives due to previous BCG.<sup>24</sup>

Since IGRA tests are unaffected by previous BCG administration or infection by non-tuberculous mycobacteria (with rare exceptions), they have high specificity and sensitivity, up to 98 and 86%, respectively. Other advantages of this test are that it is carried out on a blood sample, reducing adverse effects, the need for only one visit, and inexistence of biased reading.<sup>23,24</sup>

The definitive diagnosis occurs after a cytological sample by FNA or with histology with alcohol-acid resistant staining containing chronic granuloma with giant Langerhans cells, caseous necrosis and calcifications, associated with the

culture or polymerase chain reaction (PCR) for *Mycobacterium tuberculosis*. Chest radiography may be altered in 20 to 40% of cases.<sup>23,26</sup>

Treatment is the same used for pulmonary tuberculosis – rifampicin, isoniazid, ethambutol, and pyrazinamide for two months, followed by four months of rifampicin and isoniazid – although the response is slower. There may be persistent pain and an increase in the volume of lymph nodes while using the medications (which is called a paradoxical reaction), and surgical excision can be considered in case of severe discomfort.<sup>27</sup>

### Occult breast carcinoma

Occult breast carcinoma is a rare form of breast cancer, responsible for roughly 1% of all cases, and constitutes a diagnostic and therapeutic challenge. It is defined when there is histological confirmation of involvement of axillary lymph nodes due to carcinoma of mammary origin in the absence of clinical and radiological evidence of disease in the breast.<sup>5,28,29</sup>

Lymphadenopathy is most commonly unilateral. MMG and US should be requested in the investigation and, in case of negative findings in the breast, MRI offers additional data, with a sensitivity between 36 and 86% to detect lesions. When there are no MRI findings, we are facing a truly occult carcinoma.<sup>30,31</sup>

According to the most recent National Comprehensive Cancer Network (NCCN) guidelines for surgical treatment, modified radical mastectomy or axillary lymph node dissection with breast irradiation can be performed. Indications for chemotherapy, hormone therapy, and target therapy should follow the indications for non-occult tumors. In cases of T0 N2-3 M0 disease, neoadjuvant therapy may be performed, followed by surgical treatment.<sup>28</sup>

With the analysis of our patient's case, we found that the imaging exams did not show any breast lesion. Histology provided a safe diagnosis, with the exclusion of metastasis or primary neoplasia in axillary lymph nodes, making it possible to refer the patient to the Pneumology service. She will continue to perform breast cancer screening as indicated for her age and personal risk.

### CONCLUSION

In the presentation of axillary lymphadenopathy, several differential diagnoses must be considered, including benign and malignant diseases. Each of them has a specific treatment, which can be surgical, with medications or even consist of observation, just like in this case. The prevalence of benign causes is greater than that of malignant causes, and the diagnosis is based on clinical history and physical examination, associated with adequate exams and histological sampling, when necessary. In view of the increased incidence of cancer



over the years in our country, the percentage of lymph nodes with malignant involvement may increase.<sup>31</sup>

In the present case report, lymphadenopathy was caused by a rare benign condition of unknown etiology — sarcoidosis. The patient is oligosymptomatic, undergoing outpatient follow-up at the HJK Pneumology Service, and she also undergoes clinical examination and screening for breast cancer at the Mastology Service of Santa Casa de Belo Horizonte.

## AUTHORS' CONTRIBUTIONS

P.C.: Conceptualization, investigation, methodology, formal analysis, validation, writing – original draft, writing – review & editing.

C.V.: Conceptualization, supervision, validation, writing – original draft, writing – review & editing.

D.B.: Validation, supervision, writing – review & editing.

D.P.: Project administration, supervision, writing – review & editing.



## REFERENCES

- Lee Y, Terry R, Lukes RJ. Lymph node biopsy for diagnosis: a statistical study. *J Surg Oncol*. 1980;14(1):53-60. <http://doi.org/10.1002/jso.2930140108>
- Görkem SB, O'Connell AM. Abnormal axillary lymph nodes on negative mammograms: causes other than breast cancer. *Diagn Interv Radiol*. 2012;18(5):473-9. <http://doi.org/10.4261/1305-3825.DIR.5491-11.2>
- Urban LABD, Chala LF, de Mello GGN. *Mama*. Rio de Janeiro: Elsevier; 2019.
- Koo V, Lioe TF, Spence RA. Fine needle aspiration cytology (FNAC) in the diagnosis of granulomatous lymphadenitis. *Ulster Med J*. 2006;75(1):59-64.
- Macedo FI, Eid JJ, Flynn J, Jacobs MJ, Mittal VK. Optimal Surgical Management for Occult Breast Carcinoma: A Meta-analysis. *Ann Surg Oncol*. 2016;23(6):1838-44. <http://doi.org/10.1245/s10434-016-5104-8>
- American College of Radiology. *Breast Imaging Reporting and Data System (BI-RADS®)*. 5<sup>a</sup> ed. Reston: American College of Radiology; 2013.
- Andrade JM, Marana HR, Sarmiento Filho JM, Murta EF, Velludo MA, Bighetti S. Differential diagnosis of axillary masses. *Tumori*. 1996;82(6):596-9.
- Ferrer RL, Aronson MD, Freedman AS. Evaluation of peripheral lymphadenopathy in adults. In: Kunins L, ed. *UpToDate* [Internet]. Waltham, Mass.: UpToDate; 2020 [cited on Aug 8, 2020]. Available from: [https://www.uptodate.com/contents/evaluation-of-peripheral-lymphadenopathy-in-adults?source=history\\_widget](https://www.uptodate.com/contents/evaluation-of-peripheral-lymphadenopathy-in-adults?source=history_widget)
- Fijten GH, Blijham GH. Unexplained lymphadenopathy in family practice. An evaluation of the probability of malignant causes and the effectiveness of physicians' workup. *J Fam Pract*. 1988;27(4):373-6. <https://doi.org/10.1080/09503158808416945>
- Asano S. Granulomatous lymphadenitis. *J Clin Exp Hematop*. 2012;52(1):1-16. <http://doi.org/10.3960/jslrt.52.1>
- Walsh R, Kornguth PJ, Soo MS, Bentley R, DeLong DM. Axillary lymph nodes: mammographic, pathologic, and clinical correlation. *Am J Roentgenol*. 1997;168(1):33-8. <http://doi.org/10.2214/ajr.168.1.8976915>
- Murray ME, Given-Wilson RM. The clinical importance of axillary lymphadenopathy detected on screening mammography. *Clin Radiol*. 1997;52(6):458-61. [http://doi.org/10.1016/s0009-9260\(97\)80008-6](http://doi.org/10.1016/s0009-9260(97)80008-6)
- Shetty MK, Carpenter WS. Sonographic evaluation of isolated abnormal axillary lymph nodes identified on mammograms. *J Ultrasound Med*. 2004;23(1):63-71. <http://doi.org/10.7863/jum.2004.23.1.63>
- American Thoracic Society, European Respiratory Society, World Association of Sarcoidosis and Other Granulomatous Disorders. Statement on sarcoidosis. *Am J Respir Crit Care Med*. 1999;160(2):736-55. <http://doi.org/10.1164/ajrccm.160.2.ats4-99>
- Houssami N, Ciatto S, Turner RM, Cody HS 3rd, Macaskill P. Preoperative ultrasound-guided needle biopsy of axillary nodes in invasive breast cancer: meta-analysis of its accuracy and utility in staging the axilla. *Ann Surg*. 2011;254(2):243-51. <http://doi.org/10.1097/SLA.0b013e31821f1564>
- Ganott MA, Zuley ML, Abrams GS, Lu AH, Kelly AE, Sumkin JH, et al. Ultrasound Guided Core Biopsy versus Fine Needle Aspiration for Evaluation of Axillary Lymphadenopathy in Patients with Breast Cancer. *ISRN Oncol*. 2014;2014:703160. <http://doi.org/10.1155/2014/703160>
- Mohseni S, Shojaiefard A, Khorgami Z, Alinejad S, Ghorbani A, Ghafouri A. Peripheral lymphadenopathy: approach and diagnostic tools. *Iran J Med Sci*. 2014;39(2 Suppl.):158-70.
- Ravinsky E, Morales C. Diagnosis of lymphoma by image-guided needle biopsies: fine needle aspiration biopsy, core biopsy or both? *Acta Cytol*. 2005;49(1):51-7. <http://doi.org/10.1159/000326095>
- Freedman AS, Friedberg JW, Aster JC, Lister A. Clinical presentation and initial evaluation of non-Hodgkin lymphoma. In: Rosmarin AG, ed. *UpToDate* [Internet]. Waltham, Mass.: UpToDate; 2020 [cited on Sept 3, 2020]. Available at: [https://www.uptodate.com/contents/clinical-presentation-and-initial-evaluation-of-non-hodgkin-lymphoma?search=lymphoma&source=search\\_result&selectedTitle=1~150&usage\\_type=default&display\\_rank=1#H26](https://www.uptodate.com/contents/clinical-presentation-and-initial-evaluation-of-non-hodgkin-lymphoma?search=lymphoma&source=search_result&selectedTitle=1~150&usage_type=default&display_rank=1#H26)
- Wessendorf TE, Bonella F, Costabel U. Diagnosis of Sarcoidosis. *Clin Rev Allergy Immunol*. 2015;49(1):54-62. <http://doi.org/10.1007/s12016-015-8475-x>
- Soto-Gomez N, Peters JI, Nambiar AM. Diagnosis and Management of Sarcoidosis. *Am Fam Physician*. 2016;93(10):840-50.
- Akhtari M, Quesada JR, Schwartz MR, Chiang SB, Teh BS. Sarcoidosis presenting as metastatic lymphadenopathy in breast cancer. *Clin Breast Cancer*. 2014;14(5):e107-e110. <http://doi.org/10.1016/j.clbc.2014.05.001>

23. Fontanilla JM, Barnes A, von Reyn CF. Current diagnosis and management of peripheral tuberculous lymphadenitis. *Clin Infect Dis*. 2011;53(6):555-62. <http://doi.org/10.1093/cid/cir454>
24. Brasil. Ministério da Saúde. Secretaria de Vigilância em Saúde. Departamento de Vigilância das Doenças Transmissíveis. Manual de Recomendações para o Controle da Tuberculose no Brasil. Brasília: Ministério da Saúde; 2019.
25. Trajman A, Steffen RE, Menzies D. Interferon-Gamma Release Assays versus Tuberculin Skin Testing for the Diagnosis of Latent Tuberculosis Infection: An Overview of the Evidence. *Pulm Med*. 2013;2013:601737. <http://doi.org/10.1155/2013/601737>
26. Shriner KA, Mathisen GE, Goetz MB. Comparison of mycobacterial lymphadenitis among persons infected with human immunodeficiency virus and seronegative controls. *Clin Infect Dis*. 1992;15(4):601-5. <http://doi.org/10.1093/clind/15.4.601>
27. Jawahar MS, Rajaram K, Sivasubramanian S, Paramasivan CN, Chandrasekar K, Kamaludeen MN, et al. Treatment of lymph node tuberculosis--a randomized clinical trial of two 6-month regimens. *Trop Med Int Health*. 2005;10(11):1090-8. <http://doi.org/10.1111/j.1365-3156.2005.01493.x>
28. NCCN Clinical Practice Guidelines in Oncology (NCCN Guidelines). Version 6 [Internet]. NCCN; 2020 [cited on Sept 28, 2020]. Available from: [https://www.nccn.org/professionals/physician\\_gls/pdf/breast.pdf](https://www.nccn.org/professionals/physician_gls/pdf/breast.pdf)
29. Fayanju OM, Stoll CR, Fowler S, Colditz GA, Jaffe DB, Margenthaler JA. Geographic and temporal trends in the management of occult primary breast cancer: a systematic review and meta-analysis. *Ann Surg Oncol*. 2013;20(10):3308-16. <http://doi.org/10.1245/s10434-013-3157-5>
30. Kim SJ, Park YM. Clinical Importance and Sonographic Features of Nonpalpable Axillary Lymphadenopathy Identified on Breast Sonography in Patients Without Malignancy. *J Ultrasound Med*. 2015;34(12):2193-202. <http://doi.org/10.7863/ultra.15.01056>
31. Instituto Nacional de Câncer. Estimativa 2020. Incidência do Câncer no Brasil. Rio de Janeiro: INCA; 2019.



# Severe anaphylactic reaction to patent blue in breast cancer surgery

Cássio Furtini Haddad<sup>1\*</sup> , Debora Murad Ferreira<sup>1</sup> , Isabela Lima Cortez<sup>1</sup> ,  
Arthur José de Oliveira Vicente<sup>1</sup> , Alex Amaral Gomes Silva<sup>1</sup> , Carolina Pinheiro Naback<sup>1</sup> 

## ABSTRACT

Sentinel lymph node biopsy in the surgical treatment of initial breast cancer has been increasingly adopted to assess axillary status as a way to replace total lymphadenectomy. The sentinel lymph node can be identified using coloring agents or radiopharmaceuticals. In Brazil, patent blue is the most used dye for this type of procedure, with high rates of identification and safety; however, in some cases, the use of this substance can lead to the occurrence of anaphylactic reactions. The case presented here refers to a 41-year-old female patient admitted for a surgical procedure for total mastectomy associated with sentinel lymph node biopsy with patent blue. After surgical initiation, the patient developed severe anaphylactic shock, staying 21 days in the intensive care unit (ICU) for recovery. Most anaphylactic reactions that occur in the transoperative period are mediated by IgE antibodies, resulting in the degranulation of mast cells and basophils, with the release of mediators such as histamine, prostaglandins, proteoglycans, and cytokines, leading to the clinical manifestations of anaphylaxis. There is evidence that part of the population is allergic to patent blue, and may present with manifestations ranging from hives and pruritus to severe cardiovascular collapse, requiring hospitalization in an ICU. The purpose of this article was to report a case of severe anaphylactic reaction to patent blue and to review the literature regarding this infrequent and potentially serious situation.

**KEYWORDS:** Anaphylaxis; Hypersensitivity; Sentinel lymph node biopsy; Breast neoplasms; Coloring agents.

## INTRODUCTION

Sentinel lymph node biopsy (SLNB) in the surgical treatment of initial breast cancer has been widely used as part of the routine surgical protocol, avoiding total lymphadenectomy in most cases<sup>1</sup>. When breast cancer is metastasized, it usually spreads via the lymphatic pathway to the first lymph node affected by cancer cells, called the sentinel lymph node (SLN)<sup>2</sup>. The identification of this lymph node occurs through the use of coloring agents, such as patent blue, or radiopharmaceuticals, such as technetium, both used alone or in combination, or through indocyanine green. Patent blue is used by means of a subdermal injection in the breast, often in the periareolar region, gaining the lymphatic current, which, in turn, is drained almost entirely to the axillary region. The dye binds weakly to serum albumin and forms a complex that is captured by the afferent lymphatics, staining and identifying the SLN with a bright blue color<sup>1,3</sup>. The reaction to patent blue should also be considered in addition to the most frequently involved agents in perioperative

hypersensitivity reactions — *i.e.* neuromuscular blockers, latex, and antibiotics —, with an incidence between 0.07% to 2.7%<sup>3-6</sup>. Although rare, surgeons and anesthesiologists who perform the procedure with this type of mapping should be aware of possible adverse events and be prepared to manage them. This article aimed to report a case of severe anaphylactic reaction to patent blue used to identify SLN during breast cancer surgery, as well as to make a brief literature review on this infrequent and potentially serious situation.

## CASE REPORT

C.M.A., a female patient, aged 41 years old, admitted for mastectomy associated with SLNB and reconstruction with prosthesis. Carrier of chronic arterial hypertension, using propranolol and enalapril for control. Report of allergy to sulfa and sticking plaster. She was diagnosed with invasive carcinoma in the right breast, clinical stage cT4bN1M0, immunohistochemistry: positive ER,

<sup>1</sup>Universidade Federal de Lavras – Lavras (MG), Brazil.

\*Corresponding author: cassiohaddad@hotmail.com

Conflict of interests: nothing to declare.

Received on: 08/28/2020. Accepted on: 10/14/2020

positive PR, negative Her-2, Ki67 37% (Luminal B Her-2 negative), having been referred for neoadjuvant chemotherapy. After the end of the treatment, performed with 4 cycles of anthracycline and cyclophosphamide + 4 cycles of taxane, uneventful and with good tolerance, she returned to the surgical schedule, presenting a complete clinical response. At mammography, a regression of the nodular lesion was observed, however, irregular microcalcifications were found, in a ductal path, in the central region of the right breast, extending from the anterior to the deep region. At breast ultrasound, the nodule previously described was not visualized and lymph nodes of usual appearance in axillary regions were identified. After case discussion, a skin-sparing mastectomy associated with SLNB and immediate reconstruction with prosthesis was indicated. Preoperative exams showed no changes, and the patient was classified as having surgical risk ASA II and was released for surgery under general anesthesia, after pre-anesthetic evaluation. During surgery, she received 2 g of cefazolin minutes before anesthetic induction, which was done with remifentanyl in a continuous infusion pump (CIP), propofol (150 mg) and rocuronium (50 mg). She underwent orotracheal intubation with a 7.5 mm cuffed tube with no complications, and general anesthesia with remifentanyl (CIP) and sevoflurane was maintained. The patient also received 10 mg of IV dexamethasone during anesthetic induction. Finally, 4 ml of patent blue were injected intradermally into the periareolar region of the right breast. After about 10 minutes, the surgical procedure was started and the patient developed severe edema in the ears, diffuse erythematous lesions in the upper limbs, chest (Figure 1)



**Figure 1.** Erythema and goosebumps (*cutis anserina*) on the chest and left breast — right after the end of the surgical procedure.

and abdomen, a sharp drop in the CO<sub>2</sub> levels at the end of expiration (ETCO<sub>2</sub>), volume-refractory hypotension, ephedrine, and phenylephrine. She presented an unsatisfactory response to adrenaline (500 mcg IV), with norepinephrine initiated in CIP, reaching 30 mL/h to maintain satisfactory intra-arterial pressure (IAP), characterizing circulatory collapse. The woman did not present pulmonary auscultation compatible with bronchospasm. Anaphylactic shock was identified and hydrocortisone 500 mg IV was administered. Then, total mastectomy with SLNB was performed, without the expected immediate reconstruction, due to the severity of the condition and the patient's hemodynamic instability. Postoperatively, the patient was referred to the intensive care unit (ICU), where she remained for 21 days, having spent 10 days intubated using vasoactive drugs and corticosteroids. After discharge from the ICU, she remained hospitalized for another 16 days, with motor deficit in upper and lower limbs and dysphonia, in addition to infection of the urinary tract by multi-resistant bacteria. A computed tomography scan of the skull was performed, which showed no changes, excluding stroke or local metastasis. After a total of 37 days of hospitalization, the patient was discharged for recovery at home, with physiotherapy and speech therapy, and for the sequence of adjuvant cancer treatment.

## DISCUSSION

In Brazil, patent blue is the most used coloring agent for identifying SLN, followed, less frequently, by methylene blue, which showed an accuracy similar to that of patent blue in a randomized study<sup>7</sup>. The coloring agent can be administered by intradermal injection, as in the reported case, or intraparenchymatous injection, being captured by lymphatic vessels in the local drainage area and binding itself to albumin. Two thirds of it are absorbed in the first hour, being fully absorbed in 24 hours<sup>1,3</sup>. Excretion is done through urine and bile and the patient may observe blue-colored urine for 24 hours<sup>1,3</sup>. Usually, 0.5 to 4 ml of dye are injected, the most used dose being 2 ml. Three degrees of severity related to hypersensitivity reactions to patent blue are described: grade I, corresponding to 69%–87% of cases, characterized by bluish hives, itching and generalized rash; grade II, corresponding to 3.2-8% of cases, presenting with hypotension (systolic blood pressure <70 mmHg) without the need for vasopressors and absence of bronchospasm and laryngospasm; and grade III, corresponding to 1.1% of cases, characterized by severe cardiovascular collapse that requires a vasopressor, with suspension of the surgical procedure and transfer of the patient to the ICU<sup>1,3,8</sup>. In the present case, the patient had severe intraoperative anaphylactic reaction, which manifested as major edema in the ears, diffuse hyperemic lesions in the upper limbs, sudden drop in ETCO<sub>2</sub>, and refractory hypotension to medications, having to stay 21 days in the ICU for postoperative recovery. Thus, it

was possible to classify the hypersensitivity reaction presented as grade III. Most anaphylactic reactions occurred during the operation are mediated by IgE antibodies and are potentially more severe than non-immunological anaphylactic reactions<sup>5</sup>. IgE-mediated anaphylaxis is caused by an IgE cross-reaction that results in mast cell and basophil degranulation. In a first exposure to the allergen, TH2 cells are activated, which stimulate the production of IgE antibodies. These, in turn, bind to receptors on the surface of mast cells and basophils, sensitizing these cells. Upon re-exposure to this allergen, binding to the IgE membrane receptor stimulates sensitized mast cells and basophils to degranulate. Degranulation intensely releases mediators such as histamine, prostaglandins, proteoglycans, and cytokines, leading to clinical manifestations of anaphylaxis<sup>4,9,10</sup>. Initial sensitization has no clinical manifestation. There is evidence that about 2.7% of the population would be allergic to the blue coloring agent, a situation attributed to the sensitization caused by repeated exposure to some products, such as fabrics, cosmetics, paper, leather, and medicines that contain these dyes<sup>1,5</sup>. Some risk factors for the development of anaphylaxis are also described, such as history of atopy, allergy to drugs or food, multiple surgeries, systemic mastocytosis, and hereditary angioedema<sup>5</sup>. It is noted that, in this case, the patient had a history of allergy to sulfa and adhesive tape. It is emphasized that skin changes are not always seen immediately, due to the presence of surgical drapes, and disappear within 1–20 hours. In addition, the onset of hypersensitivity occurs between 10–45 minutes after injection of the coloring agent (mean of 17 minutes)<sup>1,3</sup>. In this case, the symptoms started about 15 minutes after the administration of the patent blue. All drugs and antiseptics used in surgery should be investigated in an anaphylactic reaction study<sup>9,11</sup>. Provided the drugs used in the anesthetic act have low allergenic potential, the fact that the patient had already used the antibiotic elected for the prophylaxis of infection in surgery, the exclusion of latex reaction, and the onset of symptoms at about 15 minutes after the administration of patent blue, the diagnostic hypothesis was a severe anaphylactic reaction to patent blue. In severe cases, arterial blood gas analysis and renal and hepatic function tests are necessary to detect hypoperfusion lesions in these organs, in addition to tests that assist in the diagnosis of anaphylaxis, such as the measurement of plasma tryptase levels and the measurement of histamine<sup>3,10</sup>. Tryptase is found in mast cells in the forms  $\alpha$ -tryptase and  $\beta$ -tryptase. In normal situations, plasma  $\alpha$ -tryptase can be found, while  $\beta$ -tryptase is only released by mast cell granules during an allergic reaction. The level of total plasma tryptase measures both of them and can be elevated during anaphylaxis and in other conditions, such as myocardial infarction, amniotic fluid embolism, or trauma<sup>3,4</sup>. Histamine, on the other hand, reaches serum levels in 5 minutes, remaining elevated for only about 30 to 60 minutes in anaphylaxis, making it more advantageous to measure its urinary

metabolites, such as methyl histamine, which is maintained up to 24 hours after the beginning of the episode<sup>10</sup>. In addition, the identification of possible allergens is an important aspect in the prevention of future anaphylaxis and can be performed through skin tests (prick and intradermal tests), measurement of specific serum IgE levels, or provocation tests<sup>4,5,11</sup>. Treatment in patients with anaphylactic reaction grades I and II is based on the use of corticosteroids (hydrocortisone, dexamethasone), antihistamines (diphenhydramine, promethazine), and volume replacement with crystalloid<sup>1</sup>. In patients classified as grade III anaphylactic reaction, there is a need for vasopressors (adrenaline, metaraminol, ethylene, ephedrine, and noradrenaline). The response to the vasopressor can be obtained with an initial dose or require prolonged infusion of the drug<sup>1,3</sup>. In this case, the patient presented refractory hypotension to volume and medication, in addition to an unsatisfactory response to adrenaline, with high-dose norepinephrine initiated, characterizing circulatory collapse. In view of the anaphylaxis, hydrocortisone was also administered. Total mastectomy with SLNB was performed, without the expected immediate reconstruction, due to the severity of the condition and the patient's hemodynamic instability, and it is recommended that the surgical procedure be completed as quickly and safely as possible in cases of perioperative anaphylaxis<sup>1,4</sup>. As reported, the patient remained in hospital for 37 days, 21 days in the ICU. In order to monitor patients, they must be admitted to the ICU in the postoperative period, since the condition can last up to 32 hours and biphasic reactions occur in up to 20% of cases. Fortunately, there are no cases of death described in the literature due to an allergic reaction to the use of patent blue<sup>1</sup>. Other ways of optimizing the prevention of this anaphylaxis were studied in addition to avoiding drugs whose tests were positive for hypersensitivity reactions, such as previous administration of glucocorticoids and antihistamines for procedures considered to be at high risk for anaphylaxis and the possibility that the use of lower coloring agent volumes can decrease allergic reactions. Further studies are needed to analyze the risk-benefit ratio of a prophylactic regimen, considering the low incidence of serious reactions and the possible adverse effects of steroids in particular<sup>12</sup>. An alternative to prevent an allergic reaction is to evaluate and test, preoperatively, each patient to confirm sensitivity to the blue dye. However, this approach, in addition to being questioned by the infrequency with which allergic reactions occur, is not so reliable, since false negative results are more likely to occur solely with a skin prick when compared to intradermal injection, which is more sensitive<sup>4</sup>. In addition to prophylaxis, there are studies, although still inconclusive, on alternative methods of localizing SLN, such as the use of green indocyanine, which depends on the generation of molecular fluorescence, and the use of supermagnetic iron oxide (SPIO) nanoparticles, both without use of radiation and with lower risk of allergy, but dependent on technological

acquisition and with difficult incorporation into the practice of most services in Brazil<sup>4</sup>. In a recent meta-analysis, Mok et al., comparing new SLN identification techniques, found superior results in terms of identification and false-negative rates with green indocyanine and SPIO nanoparticles compared to patent blue alone, and similar results when compared to the association of patent blue with technetium<sup>13</sup>. The already established use of radiopharmaceuticals and lymphoscintigraphy is not an accessible method to a considerable part of the surgical treatment centers for breast cancer, especially in the public health system, with the use of coloring agents being the option available for surgical identification of SLN.

## CONCLUSION

Hypersensitivity reactions to patent blue are infrequent, but there is evidence that 2.7% of the population may be allergic to this type of dye. The manifestations presented can vary from

hives to severe cardiovascular collapse. The reported patient had a grade III hypersensitivity reaction due to intradermal injection of patent blue. After treatment and 37 days of hospitalization, the patient progressed satisfactorily, being discharged for recovery at home. Therefore, it is extremely important that the entire medical team is aware of the possibility of an anaphylactic reaction occurring and able to identify and start treatment immediately.

## AUTHORS' CONTRIBUTIONS

C.F.H.: Conceptualization, investigation, methodology, supervision, validation, visualization, writing – review & editing.

D.M.F.: investigation, validation, writing – review & editing.

I.L.C.: formal analysis, investigation, writing – original draft.

C.P.N.: formal analysis, investigation, writing – original draft.

A.A.G.S.: formal analysis, investigation, writing – original draft.







A.J.O.V.: formal analysis, investigation, writing – original draft.

## REFERENCES

1. Maranhão MVM, Nobrega DKA, Anunciação CEC, Maia BAB, Mariano PVD. Allergic reaction to patent blue dye in breast surgery [case report]. *Rev Bras Anesthesiol*. 2016;66(4):433-6. <http://doi.org/10.1016/j.bjane.2014.02.018>
2. Wu HC, Yu JC, Yi LC, Wu CS, Lin SC, Wu ZF. Angioedema to patent blue dye in breast surgery: A case report and review of literatures. *J Med Sci*. 2019;39:43-8. [http://doi.org/10.4103/jmedsci.jmedsci\\_17\\_18](http://doi.org/10.4103/jmedsci.jmedsci_17_18)
3. Shinzato JY, Marcaccini ACP, Braga AFA, Ribeiro AR, Rubio JEM, Souza JPD. Reação anafilática ao corante azul patente durante a biópsia do linfonodo sentinela em câncer de mama inicial – relato de caso. *Rev Bras Ginecol Obstet*. 2006;28(12):728-32. <http://doi.org/10.1590/S0100-72032006001200007>
4. Iqbal FM, Basit A, Salem F, Vidya R. Feeling blue, going green and finding other attractive alternatives: a case of biphasic anaphylaxis to patent blue and a literature review of alternative sentinel node localisation methods [case report]. *BMJ*. 2015;2015:bcr2015213107. <http://doi.org/10.1136/bcr-2015-213107>
5. Faria E. Anaphylaxis to anesthetic agents [review article]. *Rev Port Imunoalergologia*. 2018;26(4):239-54.
6. Bézu C, Coutant C, Salengro A, Daraï E, Rouzier R, Uzan S. Anaphylactic response to blue dye during sentinel lymph node biopsy. *Surg Oncol*. 2011;20(1):e55-9. <https://doi.org/10.1016/j.suronc.2010.10.002>
7. Paulinelli RR, Freitas-Júnior R, Rahal RMS, Oliveira LFP, Vilela MHT, Moreira MAR, et al. A prospective randomized trial comparing patent blue and methylene blue for the detection of the sentinel lymph node in breast cancer patients. *Rev Assoc Med Bras*. 2017;63(2):118-23. <http://doi.org/10.1590/1806-9282.63.02.118>
8. Azevedo JP, Alves M, Ribeiro C, Bom AT. Anaphylactic shock perioperative to patent blue dye [case report]. *BMJ*. 2018;2018:bcr-2018-224330. <http://doi.org/10.1136/bcr-2018-224330>
9. Brenet O, Lalourcey L, Queinnee M, Dupouiron D, Jayr C, Rosay H, et al. Hypersensitivity reactions to Patent Blue V in breast cancer surgery: a prospective multicentre study. *Acta Anaesthesiol Scand*. 2013;57(1):106-11. <https://doi.org/10.1111/aas.12003>
10. Menezes TT. Anafilaxia: diagnóstico e tratamento em unidade de pronto atendimento pediátrico. *Bol Cient Pediatr*. 2014;3(2):75-8.
11. Aurich S, Seitz AT, Janina T, Simon JC, Theudler R. A Case of Anaphylaxis to Patent Blue in a Patient with Sentinel Lymph Node Excision [case report]. *Iran J Allergy Asthma Immunol*. 2016;15(6):547-50.
12. Ortiz D, Alvikas J, Riker AI. A Case of Severe Anaphylactic Reaction Secondary to Isosulfan Blue Dye Injection. *Ochsner J*. 2015;15(2):183-6.
13. Mok CW, Tan SM, Zheng Q, Shi L. Network meta-analysis of novel and conventional sentinel lymph node biopsy techniques in breast cancer. *BJS Open*. 2019;3(4):445-52. <https://doi.org/10.1002/bjs5.50157>



# Pseudoangiomatous stromal hyperplasia of the breast presenting as gigantomastia: case report

Juliana Pontes Farias<sup>1\*</sup> , Humberto Espínola Guedes Neto<sup>1</sup> ,  
Ariano Brilhante Pegado Suassuna<sup>1</sup> , Rafael Chaves Claudino de Queiroga<sup>1</sup> ,  
Arthur Antonino da Silva Nunes<sup>1</sup> , Adriano de Lima Quirino<sup>1</sup> , Thaíse Lopes Medeiros<sup>1</sup> 

## ABSTRACT

Pseudoangiomatous stromal hyperplasia (PASH) of the breast is a benign condition generally seen as an incidental finding of biopsies for other causes. In some rare cases, it can evolve with expressive growth of breast tissue, leading to large breasts. The present study presents a case report of a patient who started with breast hypertrophy during lactation, evolving with gigantomastia, and arrived at the office 3 years after gestation with breasts of 6.2 and 4.3 kg and growth of accessory breast and axillary lymph nodes. The patient was emaciated, with bodily pain and psychological distress. Computed tomography was performed with the finding of diffuse retroglandular nodules and axillary and mediastinal lymph node enlargement, without being able to rule out the lymphoproliferative process. Then, core biopsies were made in several places on the breast whose pathological examination revealed PASH samples. Bilateral mastectomy was performed as a surgical treatment, with resection of the left accessory breast and left axillary lymph node, and breast reconstruction, with placement of silicone prostheses and graft of the areola-papillary complex, together with a plastic surgeon. She evolved in the postoperative period with good healing of the surgical wound, weight gain, necrosis of the areola-papillary complex and with severe psychiatric disorder, which was treated appropriately by psychiatrists, with remission of symptoms. This case report presents a rare evolution of PASH with gigantomastia, bringing intense physical and psychological distress to the patient, whose treatment chosen was total surgical resection of the breast tissue and aesthetic reconstruction.

**KEYWORDS:** breast neoplasms; breast implantation; lactation; mastectomy; pathology.

## INTRODUCTION

Pseudoangiomatous stromal hyperplasia (PASH) is a rare benign condition of the breasts first described in 1986<sup>1</sup>, most commonly found in women in pre- and perimenopause<sup>2</sup> with findings on imaging tests not specific to this condition, requiring a correlation with the anatomopathological aspect for diagnostic confirmation<sup>3</sup>. PASH can coexist with other breast lesions or even mimic fibroadenoma and it can progress, in spite of its being a benign disease<sup>4</sup>. The diagnosis of this condition usually occurs incidentally during investigation with anatomopathological study of other benign or malignant diseases of the breast<sup>5</sup>. Treatment varies depending on the presentation.

The objective of this study was to report a case with atypical evolution and surgical treatment with bilateral mastectomy and immediate reconstruction, since the patient presented a rare and diffuse PASH condition beginning in pregnancy with rapid and bilateral breast enlargement.

## CASE REPORT

A 27-year-old woman was referred to the outpatient mastology service at the *Hospital Universitário Lauro Wanderley* (HULW), in João Pessoa, Brazil, with the complaint of bilateral gigantomastia accompanied by weight loss. She was seen for the first time in August 2019, reporting breast enlargement that started during pregnancy (three years ago) and worsened during lactation.

After the first consultation, the patient did not attend the return visit and only in February 2020 did she return to the clinic for further investigation. The breasts had almost doubled in size compared to the first consultation, with engorged vessels and areas with necrosis and suppuration (Figure 1). Diagnostic hypotheses were raised for PASH and breast lymphoma, both rare conditions. Malignant neoplasm was considered due to rapid growth, the presence of axillary lymph node enlargement and significant weight loss. Complementary investigation did not include mammography due to the patient's age and, mainly, due to the

<sup>1</sup>Hospital Universitário João Pessoa, Universidade Federal da Paraíba – João Pessoa (PB), Brazil.

\*Corresponding author: [juliana\\_pontesfarias@yahoo.com.br](mailto:juliana_pontesfarias@yahoo.com.br)

Conflict of interests: nothing to declare.

Received on: 10/04/2020. Accepted on: 11/09/2020.



**Figure 1.** (A) Front view of the breasts; (B) right breast in lateral view, with suppurative ulcer; (C) left breast in lateral view and accessory breast (photographs taken in February 2020).

impossibility of performing it in view of the technical limitations given the expressive size of the breasts. On the day of the consultation, a computed tomography (CT) scan of the chest was performed, with and without iodinated venous contrast, revealing an important volumetric increase in the breasts due to the multiple confluent nodular formations, predominantly retroglandular, which exhibited slight impregnation by means of contrast, of etiology indeterminate to the method, and it was not possible to discard a lymphoproliferative process. The presence of multiple lymph node enlargement in axillary chains and in the internal chest wall bilaterally also stands out (Figures 2A and 2B). A laboratory screening with general exams and serology was requested to rule out associated conditions and to obtain the necessary exams for surgery.

Fragments of the left breast were also collected by means of a core-biopsy for histopathological analysis. The result was released on February 10<sup>th</sup>, 2020, revealing breast tissue with pseudoangiomatous stromal hyperplasia (morphological aspects

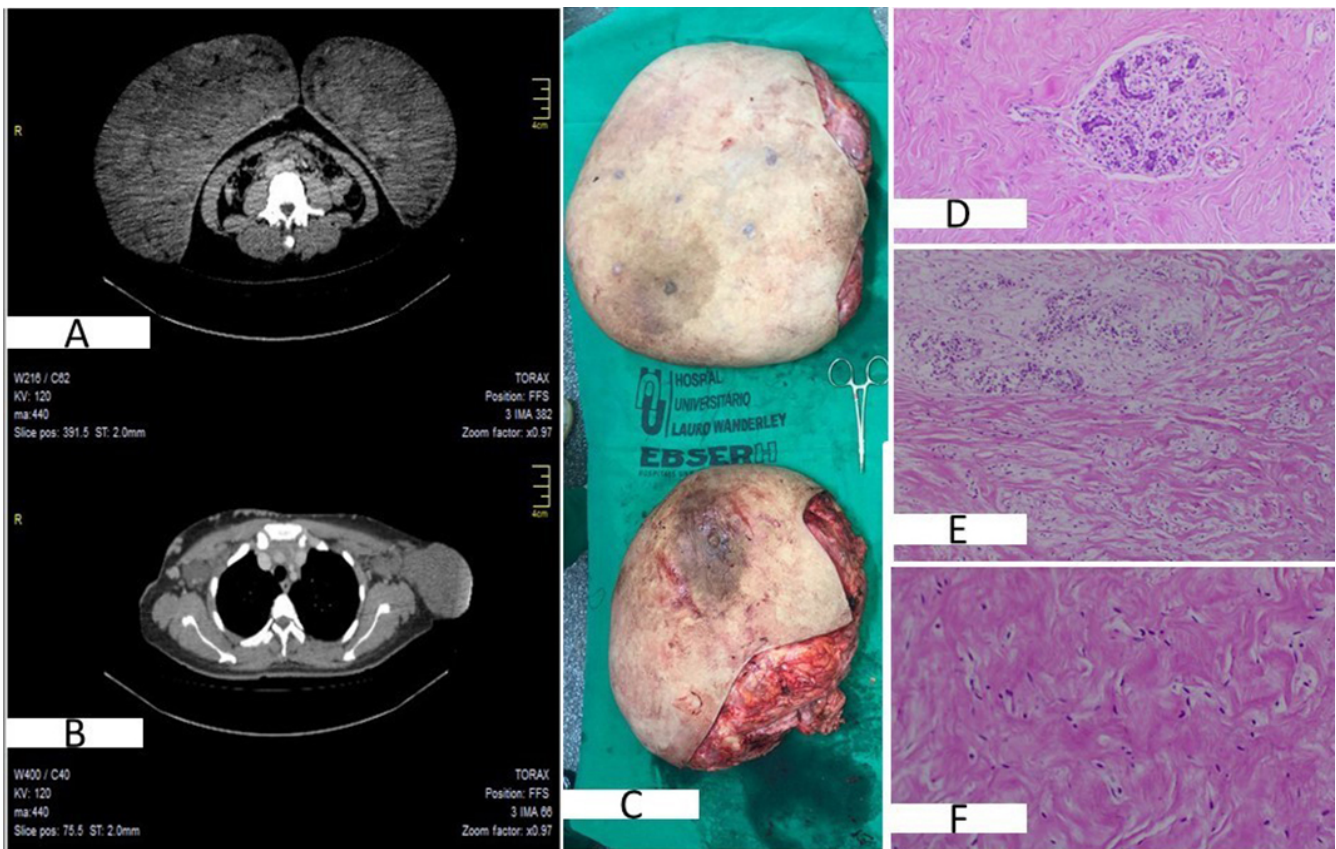

**Figure 2.** (A) Chest computed tomography shows a volumetric increase in the breasts due to multiple confluent nodular formations, predominantly retroglandular; (B) chest computed tomography highlighting the presence of multiple lymph node enlargements in axillary chains and the presence of the accessory breast on the left; (C) surgical parts of the direct and left breast (top to bottom); (D) anatomopathological showing stromal pseudoangiomatous hyperplasia, nodular and diffuse forms; (E) lymph nodes with reactive lymphoid hyperplasia; (F) absence of signs of malignancies.



consistent with the diffuse form of PASH) and absence of signs of malignancy.

On March 12<sup>th</sup>, 2020, the patient underwent bilateral total mastectomy and immediate breast reconstruction by the services of mastology and plastic surgery, respectively, at HULW. Both breasts, the left accessory breast, and the left axillary lymph nodes were resected (Figures 2C and 3A). The areola-papillary complex was preserved and used as a graft in the reconstruction of the breasts, and silicone prostheses were implanted in a submuscular position (Figure 3B).

Surgical specimens were sent for histopathological study at the Pathological Anatomy Laboratory (*Laboratório de Anatomia Patológica – LAP*) of the same hospital (Figures 2D, 2E, and 2F). The results, released on March 26<sup>th</sup>, 2020, were:

- Right breast (weight = 6,255 g; dimensions = 38 × 32 × 10 cm): pseudoangiomatous stromal hyperplasia, nodular and diffuse forms; skin without particularities; absence of signs of malignancy;
- Left breast (weight = 4,295 g; dimensions: 29 × 27 × 12 cm): pseudoangiomatous stromal hyperplasia, nodular and diffuse; skin without particularities; absence of signs of malignancy;
- Left accessory breast (dimensions = 11 × 8 × 5 cm): ectopic breast tissue with pseudoangiomatous stromal

hyperplasia; skin without particularities; absence of signs of malignancy;

- Axillary lymph nodes on the left (dimensions = 2.5 × 2 × 0.8 cm): lymph nodes with reactive lymphoid hyperplasia; absence of signs of malignancy.

In the first postoperative visit, the patient returned without complaints. On physical examination, significant edema was observed in the inframammary folds (Figure 3C). On the second return, she presented remission of these findings and complained of delusions, being referred to the psychiatric service, where drug treatment was started. In the third consultation, she showed improvements in psychiatric symptoms and the removal of the surgical stitches was performed. Partial necrosis of the areola-papillary complex grafts and progressive weight gain, around 15 kg, were observed in relation to the beginning of the follow-up (Figure 3D). The possibility of a corrective surgical procedure was offered, however, the patient expressed no interest in performing a new surgery.

The study was carried out according to the ethical principles of studies in human beings according to the Declaration of Helsinki, with the approval of the Research Ethics Committee of *Hospital Universitário Lauro Wanderley*, with CAAE number 36548520.2.0000.5183.



**Figure 3.** (A) marking and skin flaps after mastectomy; (B) frontal and lateral view of the immediate postoperative period of breast reconstruction after total mastectomy with resection of the left accessory breast; (C) postoperative period of April 2020, showing signs of partial necrosis of the areola-papillary complex grafts; (D) Late postoperative period of September 2020, showing good healing of the surgical wound, in addition to the patient's weight gain.

## DISCUSSION

PASH is a benign stromal proliferation that can affect different age groups, with a mean age ranging between 37 and 51 years<sup>6</sup>, with up to 75% of pre-menopausal patients<sup>7</sup>. The patient in this case was affected at a younger age than the average.

The precise etiology of PASH is unknown, but hormones are attributed a role in its development<sup>2</sup>, considering that almost all affected postmenopausal women were using hormone<sup>8</sup>.

There are typically two clinical types of PASH — nodular and diffuse. The nodular type is characterized by a unilateral, circumscribed, slow-growing mass and is usually an incidental finding that mimics fibroadenomas. The diffuse type is more rare, with about 20 cases reported in the literature<sup>9</sup>. The involvement of the areola-papillary complex and the axillary accessory breast are also atypical findings<sup>10</sup>. In this respect, the case has unusual characteristics, such as bilateral involvement, diffuse growth, impossibility to delimit the tumor, and the onset of an axillary accessory breast. Only two cases of PASH beginning with pregnancy have been reported<sup>9,11</sup>, as happened in the present study's patient.

A case of axillary lymph node enlargement is described in the literature, probably reactional to edema<sup>12</sup>. The patient in the present case also had a lymph node with reactive lymphoid hyperplasia.

Ultrasonographic findings are variable, ranging from circumscribed to indistinct tumors<sup>13</sup>, more commonly with the presence of a hypoechoic and heterogeneous nodule<sup>14</sup>. A study that evaluated ultrasound findings in patients with PASH classified 93.6% of the cases as BI-RADS 4, due to the fact that these exams present images with non-circumscribed margins<sup>14</sup>. One year before the appointment, the patient underwent breast ultrasound, in which no nodules or changes had been observed. On mammography, solid, non-calcified and circumscribed nodules are typically found, with focal asymmetry<sup>3</sup>. Most studies do not provide a description of this pathology on CT, therefore, this case proves to be opportune as it presents this characterization.

The main differential diagnoses, due to the clinical or histological aspects of PASH, are: fibroadenoma, phylloid tumor, and low-grade angiosarcoma<sup>2,12,14</sup>. In the present case, diagnostic doubts regarding breast lymphoma were included, due to the

presence of weight loss and rapid growth, which was discarded by breast biopsy.

In order to confirm the diagnosis, core-biopsy is sufficient and necessary in cases of abnormal findings on imaging or physical examination<sup>4</sup>. In the case of the patient under study, the tomographic finding did not rule out the presence of lymphoproliferative disease in the breasts, indicating the need for investigative supplementation with a core-biopsy, before scheduling surgical excision.

The management of PASH depends on its presentation<sup>8</sup>. Some studies recommend mastectomy in diffuse type cases<sup>3,4,8</sup> and others report<sup>9,15</sup> that immediate breast reconstruction was also performed. The surgical approach of the case is well indicated, in view of the diffuse and rapid growth and its interference in the quality of life.

## CONCLUSION

The present case revealed a rare breast condition with atypical evolution, due to rapid, diffuse, and bilateral progression. Due to the course of the disease in the patient, a surgical procedure for bilateral mastectomy and immediate breast reconstruction with prosthesis implantation was indicated. This experience reinforces the need for good propaedeutic management of PASH and adequate treatment according to the clinical picture presented, especially due to the lack of specific consensus or protocols for the disease. The individualized treatment of each patient is currently the best option, considering clinical evolution, aesthetic aspects, and results of complementary exams.

## AUTHORS' CONTRIBUTIONS

J.P.F.: supervision, methodology, writing — review.

H.E.G.N.: methodology, writing — original draft & editing.

A.B.P.S.: methodology, writing — original draft & editing.

R.C.C.Q.: methodology, writing — original draft & editing.

A.A.S.N.: methodology, writing — original draft & editing.

T.L.M.: methodology, writing — review & editing.

A.L.Q.: methodology, review.

## REFERENCES

1. Vuitch MF, Rosen PP, Erlandson RA. Pseudoangiomatous hyperplasia of mammary stroma. *Hum Pathol*. 1986;17(2):185-91. [https://doi.org/10.1016/s0046-8177\(86\)80292-1](https://doi.org/10.1016/s0046-8177(86)80292-1)
2. Smilg P. Pseudoangiomatous stromal hyperplasia: Presentation and management – a clinical perspective. *SA J Radiol*. 2018;22(2):1366. <https://dx.doi.org/10.4102%2Fsajr.v22i2.1366>
3. Raj SD, Sahani VG, Adrada BE, Scoggins ME, Albarracin CT, Woodtichartprecha P, et al. Pseudoangiomatous Stromal Hyperplasia of the Breast: Multimodality Review With Pathologic Correlation. *Curr Probl Diagn Radiol*. 2017;46(2):130-5. <http://doi.org/10.1067/j.cpradiol.2016.01.005>
4. Yoon KH, Koo B, Lee KB, Lee H, Lee J, Kim JY, et al. Optimal treatment of pseudoangiomatous stromal hyperplasia of the breast. *Asian J Surg*. 2020;43(7):735-41. <https://doi.org/10.1016/j.asjsur.2019.09.008>

5. Powell CM, Cranor ML, Rosen PP. Pseudoangiomatous Stromal Hyperplasia (PASH). *Am J Surg Pathol*. 1995;19(3):270-7. <https://doi.org/10.1097/00000478-199503000-00004>
6. Hoda SA, Brogi E, Koerner FC, Rosen PP. *Rosen's Breast Pathology*. 4<sup>th</sup> ed. Philadelphia: Wolters Kluwer Health/Lippincott Williams Wilkins; 2014. 1379 p.
7. Bourke AG, Tiang S, Harvey N, McClure R. Pseudoangiomatous stromal hyperplasia causing massive breast enlargement. *BMJ Case Rep*. 2015;2015:bcr2014204343. <https://doi.org/10.1136/bcr-2014-204343>
8. Nascimento TC, Djahjah MC, Carneiro AHPC, Oliveira AC de, Marchiori E. Pseudoangiomatous stromal hyperplasia presenting as a tumor. *Radiol Bras*. 2019;52(2):128-9. <https://doi.org/10.1590/0100-3984.2017.0135>
9. Krawczyk N, Fehm T, Ruckhäberle E, Mohrmann S, Riemer J, Braunstein S, et al. Bilateral Diffuse Pseudoangiomatous Stromal Hyperplasia (PASH) Causing Gigantomastia in a 33-Year-Old Pregnant Woman: Case Report. *Breast Care*. 2016;11(5):356-8. <https://doi.org/10.1159/000450867>
10. Virk RK, Khan A. Pseudoangiomatous Stromal Hyperplasia: An Overview. *Arch Pathol Lab Med*. 2010;134(7):1070-4. <https://doi.org/10.1043/2008-0686-RS.1>
11. Prichard RS, O'Neill CJ, O'Hara JL, Atmore BB, Hassall M. Pseudoangiomatous stromal hyperplasia of the breast: an unusual pathology necessitating bilateral mastectomy during pregnancy. *ANZ J Surg*. 2011;81(4):304-5. <https://doi.org/10.1111/j.1445-2197.2011.05688.x>
12. Tsuda B, Kumaki N, Ishida R, Sakaeda E, Ishii S, Mizuno M, et al. Rare finding of bilateral pseudoangiomatous stromal hyperplasia of the breast: A case report. *Tokai J Exp Clin Med*. 2019;44(4):73-9.
13. Polger MR, Denison CM, Lester S, Meyer JE. Pseudoangiomatous stromal hyperplasia: mammographic and sonographic appearances. *Am J Roentgenol*. 1996;166(2):349-52. <https://doi.org/10.2214/ajr.166.2.8553945>
14. Amorim HLE, Torres AF, Macedo Filho MAA, Paz AR, Pereira GCG. Análise dos achados ecográficos em nódulos de hiperplasia pseudoangiomatosa do estroma mamário diagnosticados por core biópsia. *Rev Bras Mastol*. 2011;21(2):66-9.
15. Soares AB, Queiroga RC, Soares BR, Maximiano AMC, Cardoso IF, Leal PR. Reconstrução mamária imediata após ressecção de hiperplasia estromal pseudoangiomatosa em adolescente de 13 anos. *Rev Bras Mastol*. 2011;21(3):127-30.



# Gestational gigantomastia complicated with mastitis

Calina Maria Loures de Oliveira Teixeira<sup>1</sup> , Carolina Teixeira de Assis Lopes<sup>2</sup> , Isadora Senra de Souza Resende<sup>1\*</sup> , Patricia Oliveira Carmo<sup>1</sup> , Romeu Ferreira Daroda<sup>1</sup> , Tulio Gonçalves Reis<sup>1</sup> 

## ABSTRACT

Gestational gigantomastia (GG) is a disease defined by rapid and disproportionate breast enlargement in pregnancy. Its complications may lead to emergency mastectomy or induced miscarriage. We present a case report in which pregnancy had a favorable evolution after the surgical intervention of the breasts.

**KEYWORDS:** Breast; Pregnancy; Hypertrophy; Mastitis; Mastectomy.

## INTRODUCTION

Gestational gigantomastia (GG) is a disease defined by rapid and disproportionate breast enlargement during pregnancy. Its complications may lead to emergency mastectomy or induced miscarriage<sup>1-4</sup>.

With few reports in the literature, its incidence varies from one in 28 thousand to one in 100 thousand pregnancies worldwide, so it is very rare and has unpredictable progression. The etiology and pathogenesis remain uncertain, but the most accepted theories are hormonal and autoimmune<sup>1-3</sup>.

The previous history is the strongest risk factor for its recurrence, and, despite the benignity, the clinical presentation can simulate malignancy and should be excluded initially. As a treatment, conservative modalities are ineffective, justifying surgical interventions, especially total mastectomy<sup>1,5</sup>.

## CASE REPORT

Patient R.S.C.A., 34 years old, secundigravida, 9–10 weeks of gestational age, chronic hypertension, sought medical attention at the emergency department complaining of mastalgia and increased breast volume. On physical examination, she presented extremely swollen and hyperemic breasts, palpating poorly defined tumors, the largest of which was 5 cm in the upper quadrant of the left breast (Figure 1).

She was admitted to the obstetrics service of the institution with a diagnosis of mastitis, and treated with intravenous antibiotic therapy with cephalothin and metronidazole, oral analgesia, and the doctors provided direction on general breast

care were started. The presence of thickening of the subcutaneous tissue was confirmed, with blurring of the adjacent fat, inferring an inflammatory and/or infectious process without an organized collection, associated with the presence of bulky solid hypoechoic nodules bilaterally, suggestive of fibroadenomas — Breast Imaging Reporting and Data System (BI-RADS) category 3 ultrasound.

A core biopsy guided by ultrasound was performed in the following month, whose anatomopathology revealed benign glandular breast tissue associated with a non-specific mild chronic inflammatory process. The immunohistochemical report showed negativity for neoplasm, which was observed in a negative expression of the c-erbB-2 oncoprotein correlated with a positive expression of the other antibodies. Complementary magnetic resonance imaging was not possible due to the technical difficulty caused by breast volume.

R.S.C.A. was readmitted after 40 days of core biopsy, showing an increase in breast volume with the presence of phlogistic signs (hyperemia, hyperthermia) and extensive ulcerated lesion in lower quadrants of the right breast (puncture site), without a foul odor (Figure 2). Armpits and supraclavicular fossae were free. A biopsy of the ulcerated area was performed, showing only ulceration, chronic inflammatory infiltrate, and granulation tissue and material were also sent for polymicrobial culture, which was positive for infection by multisensitive *Acinetobacter baumannii*. Vancomycin and meropenem were then started, maintained for seven days. Organic lesions were absent, but anemia was maintained, and inflammatory tests were touched in the laboratory control.

<sup>1</sup>Santa Casa de Misericórdia de Juiz de Fora – Juiz de Fora (MG), Brazil.

<sup>2</sup>Instituto Oncológico de Juiz de Fora – Juiz de Fora (MG), Brazil.

\*Corresponding author: isadorassresende@gmail.com

Conflict of interests: nothing to declare.

Received on: 01/10/2020. Accepted on: 08/06/2020

This outcome proved to be decisive in the team's decision, which was demonstrated by the failure in the usual clinical treatment of recurrent mastitis, in addition to the possible risks associated with maternal and fetal life. Due to the rarity of the pathology and the unfavorable progression of the clinical condition, despite the probable benignity until that moment, and prioritizing maternal-fetal well-being, after a broad multidisciplinary discussion, the surgical resolution of the condition was chosen, with an informed consent form signed by the patient and team. The patient underwent a simple bilateral mastectomy with removal of both breasts. The right weighed 7,660 grams and the left 4,960 grams, with drainage through a bilateral suction drain. She received red blood cells transfusions and presented a positive fetal heart rate (FHR) of 156 bpm, regular at the end of the



**Figure 1.** 34-year-old patient, presenting bilateral breast volume enlargement, extensive edema, and hyperemia, palpating poorly defined tumors.



**Figure 2.** Increased breast volume, with the presence of phlogistic signs (hyperemia, hyperthermia) and extensive ulcerated lesion in the lower quadrants of the right breast.

procedure, and absence of vaginal bleeding. The anatomopathological examination resulting from the procedure corroborated the primary findings of benignity, showing extensive lobular hyperplasia and ulcerated lesion associated with an inflammatory process. No other particularities on skin or nipple were shown.

At 38 weeks of gestational age, the patient was referred from prenatal care for pregnancy resolution due to a hypertensive peak (150 × 100 mmHg). After performing the pre-eclampsia routine laboratory evaluation and obstetric Doppler ultrasound - all exams without changes -, the labor induction was started with misoprostol administered vaginally. The patient progressed to vaginal delivery, on January 12, 2019, a female newborn, remaining in joint accommodation in the puerperium and being discharged in excellent clinical conditions, accompanied by her daughter. Future mammoplasty with bilateral breast prosthesis placement is scheduled.

## DISCUSSION

GG or grávida macromastia is defined as a disorder characterized by diffuse, extreme, and disabling enlargement of one or both breasts during pregnancy, which was first described in 1648 by Palmuth<sup>1,2,6</sup>. Its etiology is still unknown<sup>1,7,8</sup>.

The main associated physical symptoms are: breast pain, infection, ulceration, postural problems, back pain, and even postural instability. As a result of an infection not treated properly, it can progress to severe sepsis, kidney dysfunction, multiple organ dysfunction syndrome, and even death. Besides the physical problems, it can cause social, emotional, and psychological problems for women affected<sup>1,5,6</sup>.

The condition is mostly found in caucasians, multiparous, with autoimmune diseases, with no association with age or fetal gender. It can occur in any pregnancy; however, the previous history is the strongest risk factor for its recurrence, as well as the patient being submitted to mammoplasty instead of total mastectomy<sup>1,5,7</sup>. Most cases of GG are bilateral and begin in the first trimester or at the beginning of the second, coinciding with the peak period of gonadotropin production during pregnancy, which further strengthens the hypothesis of hormonal association<sup>1-3,6</sup>.

The differential diagnosis includes phyllodes tumor, fibroadenoma, and lymphomas, which must be excluded by biopsy and immunohistochemistry. Histologically, the breast tissue of patients with GG presents significant lobular hypertrophy, ductal proliferation, and periductal fibrosis<sup>1-3,6</sup>. Histological and laboratory markers of autoimmunity can also be tested, although they have not been performed in the case described<sup>5-7</sup>. Despite the benignity of GG, the clinical presentation — rapid breast enlargement, edema of the underlying tissue, the appearance of the tissue, bilateral axillary edema — can simulate malignancy and, therefore, this should be excluded initially<sup>5,6</sup>.

Treatment for GG is multiple: conservative, pharmacological, and surgical<sup>5</sup>. Several authors propose to use bromocriptine, despite the variable and generally temporary effects, with surgery being the basis of treatment<sup>4</sup>. Such medication is safe during pregnancy, although reports of isolated cases suggest delayed intrauterine growth as an isolated side effect. Therefore, it is recommended that serial fetal growth monitoring be performed in patients on bromocriptine for gigantomastia<sup>2</sup>. Although an attempt at drug treatment should be made in all patients, surgery is the treatment basis. Given the risk that surgeries will induce premature births, this should be done to postpone the surgery to a stage in which there is a viable fetus. A good indication of anticipating the surgical intervention period, in this context, would be the mastitis complication, for which the failure in immediate antibiotic therapy directed by culture and sensitivity implies obstetric risks<sup>8-10</sup>. Two main surgical modalities that have been widely used in the treatment are mammoplasty and total mastectomy<sup>9</sup>. As there is a possibility of recurrence with mammoplasty, bilateral mastectomy with reconstruction is the treatment of choice in women who want future pregnancies<sup>1-3,6</sup>.

In the past, it was customary to recommend elective pregnancy termination in patients with GG. This is definitely not relevant in today's world, due to the evolution of Medicine, anesthesia, and surgery. The care that was mostly conservative is being discouraged, and surgical treatment of this condition is chosen even during pregnancy<sup>1-5</sup>.

## CONCLUSION

GG is a benign condition that can simulate carcinomatosis, with unpredictable, markedly rapid, and progressive evolution. Its association with mastitis is a rare presentation, for which multidisciplinary efforts must be considered in breast and fetal preservation. In the presence of an unfavorable evolution for mastitis, mastectomy should be considered, aiming at maternal preservation and fetal health.

## AUTHORS' CONTRIBUTIONS

C.M.L.O.T.: conceived the present idea, conceptualization, data curation, formal analysis, investigation, visualization, writing — original draft, writing — review & editing.

C.T.A.L.: conceived the present idea, conceptualization, data curation, formal analysis, visualization, writing — original draft, writing — review & editing.

I.S.S.R.: conceived the present idea, conceptualization, data curation, formal analysis, visualization, writing — original draft, writing — review & editing.

P.O.C.: conceptualization, data curation, formal analysis, investigation, visualization, writing — original draft.

R.F.D.: conceptualization, data curation, visualization, writing — original draft.



T.G.R.: conceived the present idea, conceptualization, data curation, formal analysis, visualization, writing — original draft.

## REFERENCES

- Mangla M, Singla D. Gestational Gigantomastia: A Systematic Review of Case Reports. *J Mid-life Health*. 2017;8(1):40-4. [https://dx.doi.org/10.4103%2Fjmh.JMH\\_92\\_16](https://dx.doi.org/10.4103%2Fjmh.JMH_92_16)
- Bukhari SS, Manan H, Khan MM, Raza SS. Resolution Of Gestational Gigantomastia With Termination Of Pregnancy. *J Ayub Med Coll Abbottabad*. 2018;30(2):298-300.
- Kaluarachchi A, Rishard MRM, Ranaweera AKP, Beneragama T, Silva MVC. Gestational gigantomastia complicated with deep vein thrombosis. *Ceylon Med J*. 2018;63(2):84-5.
- Maluf Junior I, Freitas RS, Budel VM, Amaro LC, Scomação I, Roca RB, et al. Gigantomastia gestacional: como abordar essa situação clínica. *Rev Bras Cir Plást*. 2015;30(1):134-7. <http://www.dx.doi.org/10.5935/2177-1235.2015RBPC0129>
- Rezai S, Nakagawa JT, Tedesco J, Chadee A, Gottimukkala S, Mercado R, et al. Gestational Gigantomastia Complicating Pregnancy: A Case Report and Review of the Literature. *Case Rep Obstet Gynecol*. 2015;2015:892369. <https://doi.org/10.1155/2015/892369>
- Türkan H, Gökğöz MS, Ta delen I, Dündar HZ. Gestational Gigantomastia. *J Breast Health*. 2016;12(2):86-7. <https://dx.doi.org/10.5152%2Ftjbh.2016.2852>
- Touraine P, Youssef N, Alyanakian MA, Lechat X, Balleyguier C, Duflos C, et al. Breast Inflammatory Gigantomastia and Autoimmunity. *J Clin Endocrinol Metabol*. 2005;90(9):5287-94. <https://doi.org/10.1210/jc.2005-0642>
- Zhou M, Jin M, Wang L, Pan LJ. Pregnancy-associated gigantomastia recurrence and ectopic breast after reduction mammoplasty: A case report. *Cancer Biomarkers*. 2017;20(2):225-9. <https://doi.org/10.3233/cbm-160450>
- Antevski BM, Smilevski DA, Stojovski MZ, Filipovski VA, Banev SG. Extreme gigantomastia in pregnancy: case report and review of literature. *Arch Gynecol Obstet*. 2007;275(2):149-53. <https://doi.org/10.1007/s00404-006-0190-7>
- Canter JW, Oliver GC, Zaloudek CJ. Surgical Diseases of the Breast During Pregnancy. *Clin Obstet Gynecol*. 1983;26(4):853-64. <https://doi.org/10.1097/00003081-198312000-00010>



# Pharmacoeconomic analysis of the genomic test MammaPrint<sup>®</sup> use for breast cancer patients treated at a private health institution in Brazil

Fabio Postiglione Mansani<sup>1\*</sup> , Morgana Koppen<sup>2</sup> 

## INTRODUCTION

Breast cancer is the malignant neoplasia with the highest incidence in Brazilian women, below non-melanoma skin cancer<sup>1,2</sup>. About 75% of all breast cancers have a luminal biological profile (positive hormone receptors), based on the immunochemistry profile<sup>3</sup>. In addition to surgical management and hormonal treatment, some of these patients are selected to undergo chemotherapy, according to their clinical and pathological status. With the availability of some genomic tests, such as MammaPrint<sup>™</sup>, we can refine the indication of adjuvant chemotherapy, reducing financial costs associated with the use of medications and their complications, but mainly the cost of social treatment related to the significant toxicity of these therapies.

## OBJECTIVES

To analyze the financial results of MammaPrint<sup>™</sup> introduction at a private health institution in Brazil.

## MATERIALS AND METHODS

We selected patients with luminal breast carcinoma who had clinical/pathological stage I and II high risk cancer, with up to three positive lymph nodes, according to the MINDACT study criteria<sup>4</sup>. We analyzed the cost of adjuvant chemotherapy with the most frequently used regimens for luminal tumors (docetaxel + cyclophosphamide – TC x 4 and doxorubicin + cyclophosphamide – AC-T weekly), according to the pharmaceutical guidelines by Brasíndice 2019<sup>5</sup>, using a body surface area of 1.7 m<sup>2</sup> equivalent to the median found in patients treated at the *Instituto Sul Paranaense de Oncologia* (ISPON). Commercial cost of MammaPrint<sup>™</sup> in Brazil in February 2019 was BRL 14,000.00 (approximately USD \$ 3,500.00 – Gencell Pharma). A pharmacoeconomic analysis was performed according to a reduction in the indication of chemotherapy using

MammaPrint<sup>™</sup>, based on the results presented in the MINDACT study. Costs include medications and infusion supplies, and do not include medical fees and treatment of complications.

## RESULTS

The costs for the eight cycles of the weekly AC-T scheme represent BRL 75,070.80 (USD \$ 18,767.70), as in Table 1. Applying a 46% reduction of the indicated chemotherapy, according to the MINDACT study, and adding the cost of MammaPrint<sup>™</sup> to all patients, we reached BRL 54,538.23 (USD \$ 13,634.55) on average per patient, representing savings of BRL 20,532.56 (USD \$ 5,133.14) for each individual. When we evaluated the TC scheme for four cycles, we obtained a value of BRL 38,763.28 (USD \$ 9,690.82) for each patient. Applying the same 46% reduction in the chemotherapy indication and adding the cost of MammaPrint<sup>™</sup>, we obtained an average of BRL 35,707.43 (USD \$ 8,926.86), representing savings of BRL 3,055.85 (USD \$ 763.96) per patient (Figures 1 and 2).

## CONCLUSION

When analyzing the application of the genomic test MammaPrint<sup>™</sup> in breast cancer patients, according to the MINDACT study criteria, we observed a reduction in the mean cost per patient with the two most widely used adjuvant chemotherapy schemes in tumors with a luminal profile. The costs may vary according to the commercial negotiations and the structure of each service; therefore, individualized evaluation is required.

## AUTHORS' CONTRIBUTIONS

M.K.: analysis of date and costs; tables, figures and text review.

F.P.M.: research and date structuring, comparative analysis and preparation of final manuscript.

<sup>1</sup>Universidade Estadual de Ponta Grossa – Ponta Grossa (PR), Brazil.

<sup>2</sup>Instituto Sul Paranaense de Oncologia – Ponta Grossa (PR), Brazil.

\*Corresponding author: fabiomansani@uol.com.br

Conflict of interests: nothing to declare.

Received on: 04/27/2020. Accepted on: 07/07/2020.

**Table 1.** Antineoplastic drugs and costs of supplies for each infusion in USD.

	\$ Unitary	AC	Paclitaxel	TC
<b>Antineoplastic drugs</b>				
Doxorubicin 10 mg	26.58	26.58		
Doxorubicin 50 mg	111.67	223.34		
Cyclophosphamide 200 mg	3.86	3.86		3.86
Cyclophosphamide 1,000 mg	14.33	14.33		14.33
Paclitaxel 30 mg	204.62		204.62	
Paclitaxel 100 mg	683.43		683.43	
Docetaxel 20 mg	332.29			996.87
Docetaxel 80 mg	1,194.79			1,194.79
<b>Adjuvant medicines and supplies</b>				
Distilled water 100 mg	1.60	1.60		1.60
Cimetidine 300 mg	0.53		0.53	
Dexamethasone 10 mg (ampoules)	3.60	3.60	7.20	3.60
Dexamethasone 4 mg (tablets)	0.25	2.50		5.00
Diphenhydramine 50 mg	5.12		5.12	
Ondansetron 8 mg	40.56		40.56	
Aprepitant 150 mg	90.12	90.12		
Palonosetron 0.25 mg	93.45	93.45		93.45
Glucose solution 5% 500 mL	1.64		1.64	
Sodium chloride 0.5% 100 mL	1.93	3.86	1.93	1.93
Sodium chloride 0.5% 500 mL	1.67	1.67	1.67	1.67
Sodium chloride 0.5% 1,000 mL	2.72	2.72	2.72	2.72
<b>Medical materials</b>				
Disposable needle	0.54	5.40	2.70	3.24
Intravenous catheter	26.12	26.12	26.12	26.12
Infusion connection	3.82	3.82	3.82	3.82
Macro dropet equipment	1.73	9.62	5.19	5.19
Infusion pump equipment	187.11		187.11	
Infusion filter	45.24		45.24	
Sterile surgical glove	0.77	1.54	1.54	1.54
Luer off protector for syringe	2.38	16.66		
Disposable syringe 3 mL	0.38		0.38	
Disposable syringe 5 mL	0.46	0.92	0.46	
Disposable syringe 10 mL	0.62		0.62	1.86
Disposable syringe 20 mL	1.83	10.98	1.83	5.49
Disposable syringe 60 mL	7.16	7.16	7.16	7.16
<b>Services/fees</b>				
Short infusion (room rate)	75.00	75.00		75.00
Long infusion (room rate)	125.00		125.00	
Total expenses for infusion (USD)		625.05	1,356.59	2,449.24

AC: doxorubicin + cyclophosphamide; Paclitaxel w: paclitaxel weekly; TC: docetaxel + cyclophosphamide.

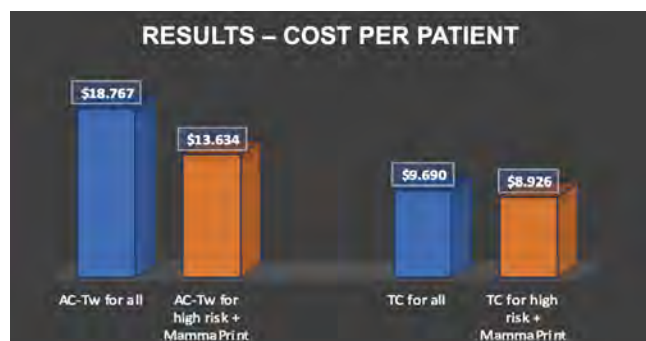
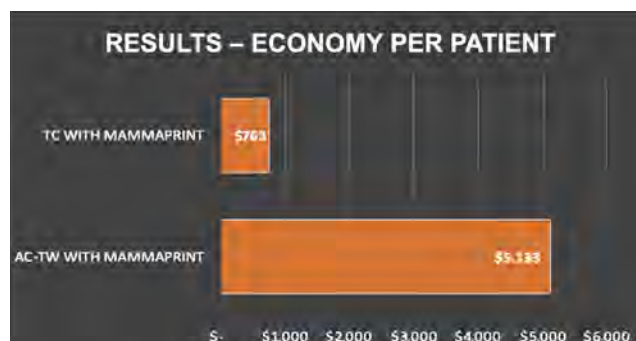
**Figure 1.** Results: cost per patient.**Figure 2.** Economy per patient.



## REFERENCES

1. Brasil. Instituto Nacional de Câncer José Alencar Gomes da Silva. Estimativa 2018 [Internet]. [cited on Jun 30, 2019]. Available at: <https://www.inca.gov.br/numeros-de-cancer>
2. Globocan 2018. Global cancer incidence [Internet]. [cited on Jun 30, 2019]. Available at: <https://www.uicc.org/news/new-global-cancer-data-globocan-2018>
3. Prat A, Parker JA, Karginova O, Fan C, Livasy C, Herschkowitz JI, et al. Phenotypic and molecular characterization of the claudin-low intrinsic subtype of breast cancer. *Breast Cancer Res.* 2010;12(5):R68. <https://doi.org/10.1186/bcr2635>
4. Cardoso F, van't Veer LJ, Bogaerts J, Slaets L, Viale G, Delaloge S, et al. 70-Gene Signature as an Aid to Treatment Decisions in Early-Stage Breast Cancer. *New Engl J Med.* 2016;717-29. <https://doi.org/10.1056/NEJMoa1602253>
5. Brasíndice. [Internet]. [cited on Jun 15, 2019]. Available at: <http://www.brasindice.com.br/>



# Multidisciplinary approach in the clinical and laboratory investigation of a suspected case for anaplastic lymphoma associated with breast prosthesis

René Aloisio da Costa Vieira<sup>1,2,3\*</sup>, Idam de Oliveira-Junior<sup>1,2</sup>, Luciana da Fonseca Santos<sup>2</sup>, Ana Paula Uema Watanabe<sup>2</sup>, Wilson Eduardo Furlan Matos Alves<sup>2</sup>, Luciano Neder<sup>2,4,5</sup>

## ABSTRACT

**Introduction:** Breast implant-associated anaplastic large cell lymphoma (BIA-ALCL) is a rare subtype of CD30-positive and ALK-negative (anaplastic lymphoma kinase) T cell lymphoma, which can develop in the pericapsular fibrous tissue and the late seromas around breast implants. If BIA-ALCL is suspected, an adequate diagnostic flow is essential. **Materials and methods:** A flowchart of the procedures performed in the diagnostic investigation is discussed, associating a clinical case, and conducting a review on the topic. **Results:** In the assessment of late and recurrent periprosthetic seromas, prior communication from the surgeon and the pathologist is essential, aiming at the adequate collection and storage of the aspirated material. The material must be promptly fractionated for microbiological assessment by culture, immediate or transoperative cytologic assessment, immunophenotyping by flow cytometry (10 mL), direct cytopathological examination, and obtaining cell block material (50 mL). For flow cytometry, the material must be sent fresh, 70% alcohol or 10% buffered formalin can be added for the other procedures. If it is impossible to send the aspirated fluid to the laboratory in less than six hours, it can be temporarily stored in a refrigerator at 4°C. Immunophenotyping should be extensive, always assessing the expression of CD30 and ALK, regardless of cytological aspects. In cases of late and recurrent seromas in which BIA-ALCL is considered, even if initially discarded, it is suggested to perform capsulectomy with the removal of the prosthesis or careful clinical and laboratory monitoring. **Conclusion:** The diagnostic flowchart is essential, aiming at false-negative tests.

**KEYWORDS:** lymphoma, large cell, anaplastic; breast implants; lymphoma; seroma.

## INTRODUCTION

Breast implant-associated anaplastic large cell lymphoma (BIA-ALCL) is a rare and indolent subtype of CD30-positive non-Hodgkin's lymphoma, primarily associated with breast implants, but which does not have translocations or expression of anaplastic lymphoma kinase (ALK) (ALK-negative ALCL). BIA-ALCLs are a subtype of T lymphoma that represents 10% of non-Hodgkin's lymphomas of the breast, which, in turn, correspond to <1% of breast neoplasms<sup>1</sup>. The incidence of BIA-ALCL is 1 case for 500,000 to 3,000,000 women with late periprosthetic seroma.

Late periprosthetic seroma is a rare clinical entity, seen in less than 1% of cases with breast implants after one year<sup>2</sup>. Although the estimated individual risk for the development of seromas after textured implants is up to 10%<sup>3,4</sup>, the occurrence of late seromas is rare (0.05% to 0.1%), and other differential diagnoses, such as trauma and infections, should be considered<sup>5,6</sup>.

The development of this subtype of T lymphoma is associated with, on average, 9 to 11 years after the placement of textured breast implants<sup>7-9</sup>. Long as this time may be, cases of BIA-ALCL have been described in up to two months, shortly after the replacement of breast implants<sup>9</sup>. More recently, it has been

<sup>1</sup>School of Medicine of Botucatu – Botucatu (SP), Brazil.

<sup>2</sup>Barretos Cancer Hospital – Barretos (SP), Brazil.

<sup>3</sup>Muriae Cancer Hospital – Muriae (MG), Brazil.

<sup>4</sup>Ribeirão Preto Medical School, Universidade de São Paulo – Ribeirão Preto (SP), Brazil.

<sup>5</sup>Department of Pathology, Rede D'Or São Paulo – São Paulo (SP), Brazil.

\*Corresponding author: reneacv@terra.com.br

Conflict of interests: nothing to declare.

Received on: 05/20/2020. Accepted on: 06/03/2020.

proposed that the development of BIA-ALCL is associated with three main factors: textured breast implants, bacterial infection (biofilm), and genetic predisposition<sup>10</sup>.

Since the report of the first case, in 1997<sup>11</sup>, in a patient who had undergone cosmetic surgery for a breast implant, about 600 cases of BIA-ALCL have been described in the literature so far<sup>12</sup>. Immunophenotypically, BIA-ALCLs are indistinguishable from other anaplastic lymphomas of CD30-positive and ALK-negative T cells, and their diagnosis requires adequate clinical and laboratory assessment, which can be problematic in some cases. Some special care must be taken in the preservation of the material, which will be subjected to cytopathological analysis, immunohistochemistry assessment, and flow cytometry with immunophenotyping, which must include CD30 and ALK<sup>13-16</sup>. Therefore, a multidisciplinary approach and observance of a protocol of procedures are necessary to avoid the occurrence of false-negative results, a fact that motivated the present study.

## MATERIALS AND METHODS

The study was approved by the Research Ethics Committee of Hospital do Câncer de Barretos, under No. 23026719.5.0000.5437/2019. An attempt was made to carry out a contextualized review on the topic, aiming to describe the procedure flowchart, the

diagnostic steps, and the therapeutic care that must be performed by the mastologist. The diagnostic flowchart was exemplified using a suspected case of BIA-ALCL, in which extensive radiological and pathological assessment did not confirm the presence of this neoplasm.

## RESULTS

A 42-year-old patient with bilateral additive mammoplasty for seven years and a history of late and recurrent seroma in the right breast associated with pruritus, sweating, and nocturnal chills for three weeks was submitted to assessment by mammography and breast ultrasound (BUS), showing locoregional axillary adenomegaly with cortical thickening, more significant on the right, and large ipsilateral periprosthetic collection (Figure 1).

Cytopathological assessment of the axillary lymph node and the right seroma was carried out by fine-needle aspiration, the results of which indicated a suspected lymphoma. Then, a radio-guided excision of the right axillary lymph node was the procedure of choice, whose histopathological assessment showed only reactive lymphoid hyperplasia.

Subsequently, she underwent breast magnetic resonance imaging (MRI), which showed no mass or adenopathy, and positron emission tomography-computed tomography (PET-CT),

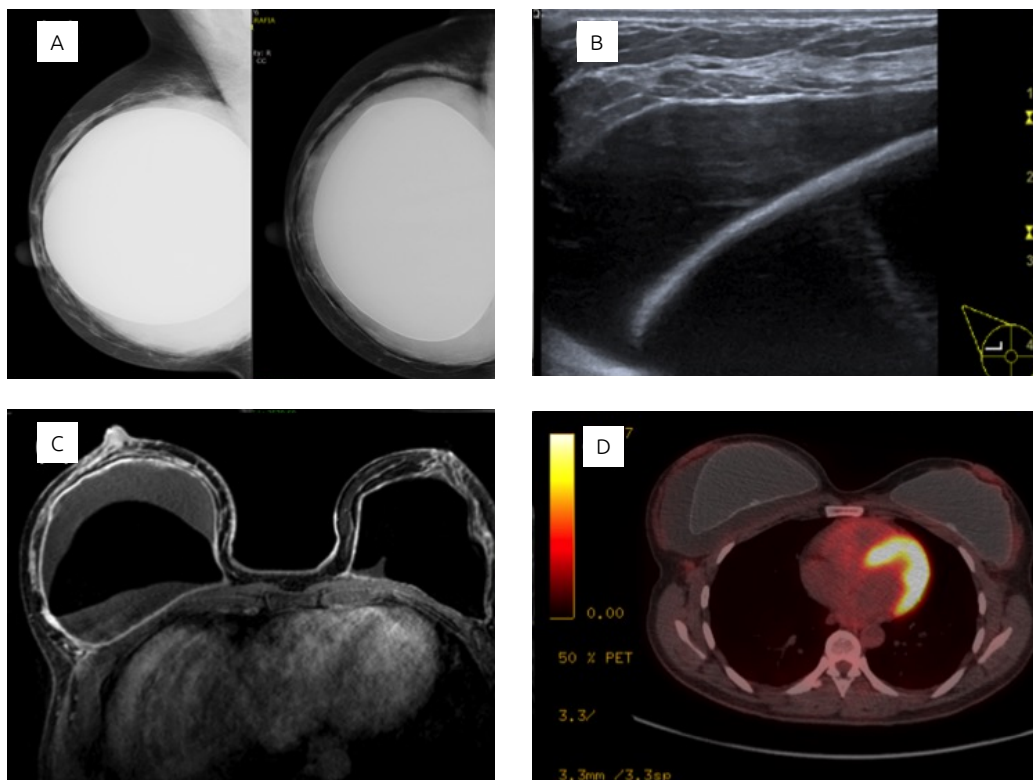

**Figure 1.** Negative radiological findings: (A) mammography; (B) breast ultrasound; (C) magnetic resonance; (D) positron emission computed tomography.

which did not show any point of capture in the capsule or the axilla (Figure 1).

The patient underwent unilateral surgery, which consisted of total capsulectomy with the removal of the right prosthesis (Figure 2). During the surgical procedure, a direct cytological examination was carried out using cytospin smears of the aspirated fluid, with the suppurative and/or infectious process being discarded. Subsequently, separate sample syringes were collected for microbiological assessment by culture, 10 mL of the seroma for the flow cytometry exam, and 50 mL for the cytopathological exams and cell block immunohistochemistry.

Cytomorphological, microbiological, immunohistochemistry, and flow cytometry analyses ruled out lymphoma and infectious processes, showing only fibrosis and a mild reactive and polyclonal inflammatory cell infiltrate.

The patient progressed satisfactorily and was submitted to a new breast implant after four months.

## DISCUSSION

The clinical presentation of BIA-ALCL is a collection of periprosthetic fluid (seroma) in 80% to 90% of cases, usually late and recurrent, as observed in the example case. Other presentations include breast swelling, asymmetry, pain, tumor mass around the implant, and local hyperemia<sup>7,8</sup>. The presentation as a tumor mass with lymph node involvement is rare, being observed in only 10% to 20% of patients, who may have cutaneous lesions, contraction of the implant capsule, and even B symptoms<sup>7</sup>.

Once seroma is the main clinical manifestation, patients are usually initially assessed by BUS and submitted to aspiration of the fluid. In patients with a non-compliant mass or irregularities in the capsule, the diagnosis is facilitated by clinical suspicion and the possibility of performing core biopsy, but this situation is uncommon. Although BUS is the most used test in the initial assessment, in inconclusive cases, computed tomography (CT) or, preferably, MRI can be associated<sup>14</sup> before considering the possibility of surgical treatment. PET-CT can be used in cases

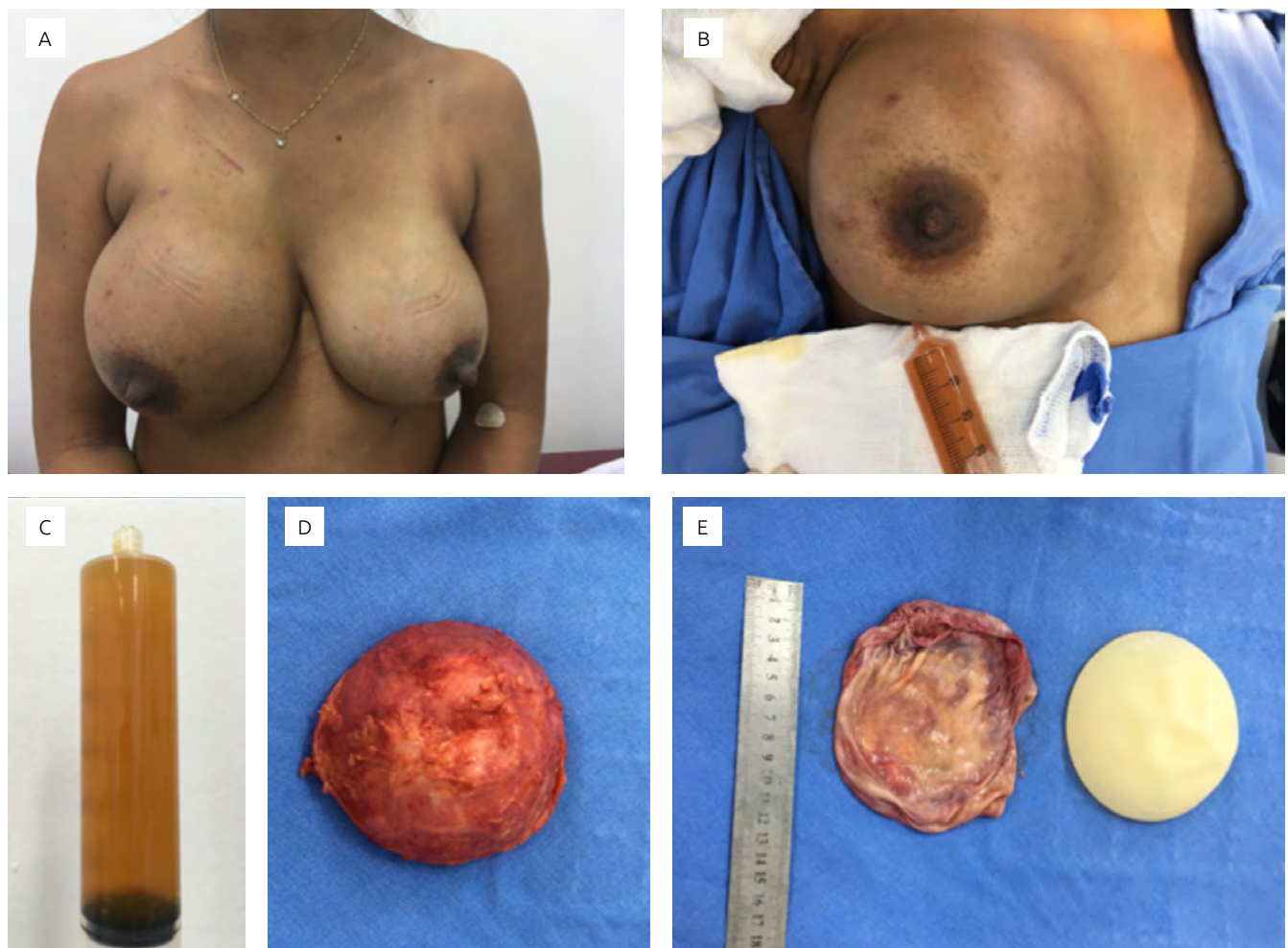

**Figure 2.** Clinical and surgical findings: (A) preoperative; (B) emptying of the seroma; (C) yellowish seroma; (D) total capsulectomy; (E) capsule without vegetation with the full textured prosthesis.

with high clinical suspicion of malignancy, or even in confirmed cases of BIA-ALCL to improve staging.

In the diagnostic assessment before surgery, it is suggested to perform, whenever possible, the immunophenotyping of the periprosthetic fluid by flow cytometry. The cytological and immunophenotyping assessment of the seroma is very important since, in stage I, BIA-ALCL is confined to effusion<sup>3</sup>.

The sensitivities of BUS, CT, MRI, and PET-CT for infusion detection are 84%, 55%, 52%, and 38%, while for tumor mass sensitivities are 46%, 50%, 50%, and 64%, respectively<sup>17</sup>. Since the inflammatory process resulting from the surgical procedure can interfere with the results, PET-CT, if not performed before surgery, can be performed only after two to three months<sup>14</sup>. In the case presented, although the only radiological findings were associated with periprosthetic seroma, PET-CT showed no changes.

Some care is needed with the collected fluid to avoid false-negative results. The aspiration puncture of the seroma with a cytological assessment on the same day is mandatory (less than six hours is considered adequate) to avoid cell degradation. If it is impossible to send the material to the laboratory in less than six hours, the material must be kept in a refrigerator at 4°C for up to 24 hours. In the presence of longer periods, the fluid must be discarded<sup>18</sup>, a fact that emphasizes the need to forward the material in the shortest possible time.

The pathologist must be informed in advance about the case, the date of the procedure, and the time that the material will be sent. It is suggested that no less than 50 mL of seroma be collected for cytopathological assessment and *cell block* preparation. At the same time, for flow cytometry immunophenotyping, it is recommended that at least 10 mL of aspirated fluid be collected in separate syringes.

The collected fluid can be viscous, serous, or hemorrhagic, when anticoagulant can be added, such as ethylenediaminetetraacetic acid or heparin. The fluid must be subjected to direct cytological assessment (Hematoxylin and Eosin stains, pap smear, Wright-Giemsa or May-Grünwald-Giemsa stain, according to the preference of the laboratory), immunohistochemical reactions in the cell block and immunophenotyping by flow cytometry, particularly to assess CD30 and ALK expression, regardless of morphological and cytological aspects.

There are several advantages in performing the cell block since the cytocentrifugation of the collected fluid makes it possible to obtain low-volume, high-cellularity, and paraffin-embedded material, which makes it possible to perform additional cuts and immunohistochemical reactions. The material can be sent without preservatives (*in natura*), or 70% alcohol, methyl alcohol, or 10% buffered formalin can be added, depending on the preference of the laboratory<sup>18,19</sup>.

The minimum panel of antibodies used in flow cytometry must contain the anti-CD30, -CD163 and/or -CD68, -CD3, -CD20, -ALK, and pan-cytokeratin assessment, aiming to differentiate

BIA-ALCL from other B or T lymphomas, reactive macrophages, and carcinomas<sup>8,19</sup>. Classically, the diagnosis of BIA-ALCL is based on the detection, by flow cytometry, of CD30-positive and ALK-negative T lymphocytes in more than 10% of the cells in the aspirated fluid. For immunophenotyping, other markers can be used, such as CD5, CD2, CD7, CD43, CD4, CD8, granzyme B, and TIA1<sup>18</sup>. However, Kadin et al.<sup>19</sup> detected >23% of CD30-positive T lymphocytes in late periprosthetic seroma in a 69-year-old patient. By investigating rearrangements of T cell antigenic receptors (TCRs), both in seroma and in peripheral blood, the authors concluded that these were activated T lymphocytes, which was consistent with local and peripheral immune responses, probably to bacterial superantigens that could be present in the biofilm formed on the surface of the prosthesis. These findings put into question the conception that the simple detection of >10% of CD30-positive T lymphocytes in late seromas is sufficient for the diagnosis of BIA-ALCL, making it necessary, before closing the diagnosis, to employ a wide antibody panel and the joint assessment of immunohistochemical findings (cell block) and immunophenotyping by flow cytometry. Still, the investigation of TCR clonality and the assessment of mutations in the JAK1 and STAT3 genes can be of great help in doubtful cases<sup>7</sup>.

The presence of a previous infectious and/or inflammatory process is related to the development of seromas, which may be secondary to infections, trauma, or rupture of the prosthesis. As BIA-ALCL can be found in up to 10% of cases of late and recurrent seromas, it is plausible to consider the hypothesis that the malignant transformation occurs through the infiltration of inflammatory cells present in the seroma. Such a fact would justify the emptying of the seroma with the removal of the capsule and prosthesis in the late and recurrent seromas, as performed in the case analyzed in this study.

In the presence of evidence or highly suspected BIA-ALCL, the standard surgical procedure consists of emptying the periprosthetic content, capsulectomy, and removal of the breast prosthesis<sup>16</sup>, as performed in the present case. Generally, BIA-ALCL is confined to the fibrous capsule. However, it may present further infiltration<sup>3</sup>, with no indication of removal of the breast parenchyma. In the presence of a tumor mass, the concomitant resection of the tumor is suggested, with free margins<sup>20</sup>, since patients with complete resection present better outcome<sup>14</sup>.

Although the presence of bilateral disease occurs in only 4.6% of cases, in the presence of BIA-ALCL, bilateral implant and capsule surgery is suggested<sup>14</sup>. In cases of BIA-ALCL, the placement of a new prosthesis is discouraged<sup>20</sup>. However, when there is only diagnostic suspicion, the indication of bilaterality becomes questionable, and the surgeon must previously discuss this fact with the patient. In patients whose BIA-ALCL has not been confirmed, a new prosthesis may, in the future, be placed, as performed in the present case.

About 20% of cases have metastatic lymph node disease so that in the absence of lymph node enlargement, lymph nodelectomy is not recommended, and there are no indications for the investigation of sentinel lymph node<sup>7</sup>. Axillary lymphadenectomy has rarely been recommended, due to lymph node involvement by lymphoma<sup>14</sup>.

In patients with BIA-ALCL, the approach should be discussed in a multidisciplinary manner, with the participation of the mastologist and/or plastic surgeon, the hematologist, and the oncologist, with complete clinical staging, according to the tumor-nodule-metastasis system<sup>13,14</sup>. Adjuvant treatment is conducted with the team of clinical oncology or hematology, and the follow-up must be carried out, jointly, every three to six months in the first two years<sup>6</sup>. Adequate management of these patients is essential for therapeutic success.

## CONCLUSION

BIA-ALCL is a rare subtype of non-Hodgkin's lymphoma with an indolent course, but which has been described with increasing

frequency and associated with recurrent seromas with late development after the placement of textured breast implants. The establishment of a multidisciplinary approach with the observance of a clinical and laboratory investigation protocol is fundamental for the diagnostic resolution, the appropriate clinical management, and the reduction of false-negative cases.

## AUTHORS' CONTRIBUTIONS

RACV: Conceptualization; Data curation; Formal analysis; Investigation; Supervision; Writing — original draft; Writing — review and editing.

IOJ: Conceptualization; Data curation; Investigation; Writing — review.

Santos LF: Data curation; Formal analysis; Investigation; Writing — original draft; Writing — review.

AUW: Data curation; Investigation; Writing — review.

LN: Conceptualization; Data curation; Formal analysis; Investigation; Writing — original draft; Writing — review.

## REFERENCES

- Aladily TN, Nathwani BN, Miranda RN, Kansal R, Yin CC, Protzel R, et al. Extranodal NK/T-cell lymphoma, nasal type, arising in association with saline breast implant: expanding the spectrum of breast implant-associated lymphomas. *Am J Surg Pathol*. 2012;36(11):1729-34. <https://doi.org/10.1097/pas.0b013e31826a006f>
- Ronchi A, Montella M, Argenzio V, Lucia A, De Renzo A, Alfano R, et al. Diagnosis of anaplastic large cell lymphoma on late peri-implant breast seroma: Management of cytological sample by an integrated approach. *Cytopathology*. 2018;29(3):294-9. <https://doi.org/10.1111/cyt.12541>
- Clemens MW, Medeiros LJ, Butler CE, Hunt KK, Fanale MA, Horwitz S, et al. Complete Surgical Excision Is Essential for the Management of Patients With Breast Implant-Associated Anaplastic Large-Cell Lymphoma. *J Clin Oncol*. 2016;34(2):160-8. <https://doi.org/10.1200/jco.2015.63.3412>
- Mehta-Shah N, Clemens MW, Horwitz SM. How I treat breast implant-associated anaplastic large cell lymphoma. *Blood*. 2018;132(18):1889-98. <https://doi.org/10.1182/blood-2018-03-785972>
- Clemens MW, Nava MB, Rocco N, Miranda RN. Understanding rare adverse sequelae of breast implants: anaplastic large-cell lymphoma, late seromas, and double capsules. *Gland Surg*. 2017;6(2):169-84. <https://doi.org/10.21037/gs.2016.11.03>
- Di Napoli A, Pepe G, Giarnieri E, Cippitelli C, Bonifacino A, Mattei M, et al. Cytological diagnostic features of late breast implant seromas: From reactive to anaplastic large cell lymphoma. *PLoS One*. 2017;12(7):e0181097. <https://doi.org/10.1371/journal.pone.0181097>
- Marra A, Viale G, Pileri SA, Pravettoni G, Viale G, De Lorenzi F, et al. Breast implant-associated anaplastic large cell lymphoma: A comprehensive review. *Cancer Treat Rev*. 2020;84:101963. <https://doi.org/10.1016/j.ctrv.2020.101963>
- Quesada AE, Medeiros LJ, Clemens MW, Ferruffino-Schmidt MC, Pina-Oviedo S, Miranda RN. Breast implant-associated anaplastic large cell lymphoma: a review. *Mod Pathol*. 2019;32(2):166-88. <https://doi.org/10.1038/s41379-018-0134-3>
- Ebner PJ, Liu A, Gould DJ, Patel KM. Breast implant-associated anaplastic large cell lymphoma, a systematic review and in-depth evaluation of the current understanding. *J Surg Oncol*. 2019;120(4):573-7. <https://doi.org/10.1002/jso.25626>
- Rastogi P, Deva AK, Prince HM. Breast Implant-Associated Anaplastic Large Cell Lymphoma. *Curr Hematol Malig Rep*. 2018;13(6):516-24. <https://doi.org/10.1007/s11899-018-0478-2>
- Keech JA, Jr., Creech BJ. Anaplastic T-cell lymphoma in proximity to a saline-filled breast implant. *Plast Reconstr Surg*. 1997;100(2):554-5. <https://doi.org/10.1097/00006534-199708000-00065>
- Groth AK, Graf R. Breast Implant-Associated Anaplastic Large Cell Lymphoma (BIA-ALCL) and the Textured Breast Implant Crisis. *Aesthetic Plast Surg*. 2020;44(1):1-12. <https://doi.org/10.1007/s00266-019-01521-3>
- Laurent C, Haioun C, Brousset P, Gaulard P. New insights into breast implant-associated anaplastic large cell lymphoma. *Curr Opin Oncol*. 2018;30(5):292-300. <https://doi.org/10.1097/cco.0000000000000476>
- Clemens MW, Jacobsen ED, Horwitz SM. 2019 NCCN Consensus Guidelines on the Diagnosis and Treatment of Breast Implant-Associated Anaplastic Large Cell Lymphoma (BIA-ALCL). *Aesthet Surg J*. 2019;39(Suppl. 1):S3-S13. <https://doi.org/10.1093/asj/sjy331>

15. Clemens MW, Brody GS, Mahabir RC, Miranda RN. How to Diagnose and Treat Breast Implant-Associated Anaplastic Large Cell Lymphoma. *Plast Reconstr Surg.* 2018;141(4):586e-599e. <https://doi.org/10.1097/prs.0000000000004262>
16. Jones JL, Hanby AM, Wells C, Calaminici M, Johnson L, Turton P, et al. Breast implant-associated anaplastic large cell lymphoma (BIA-ALCL): an overview of presentation and pathogenesis and guidelines for pathological diagnosis and management. *Histopathology.* 2019;75(6):787-96. <https://doi.org/10.1111/his.13932>
17. Adrada BE, Miranda RN, Rauch GM, Arribas E, Kanagal-Shamanna R, Clemens MW, et al. Breast implant-associated anaplastic large cell lymphoma: sensitivity, specificity, and findings of imaging studies in 44 patients. *Breast Cancer Res Treat.* 2014;147(1):1-14. <https://doi.org/10.1007/s10549-014-3034-3>
18. Di Napoli A. Achieving Reliable Diagnosis in Late Breast Implant Seromas: From Reactive to Anaplastic Large Cell Lymphoma. *Plast Reconstr Surg.* 2019;143(3S A Review of Breast Implant-Associated Anaplastic Large Cell Lymphoma):15S-22S. <https://doi.org/10.1097/prs.0000000000005565>
19. Kadin EM, Morgan J, Xu H, Glicksman A. CD30+ T Cells in Late Seroma May Not Be Diagnostic of Breast Implant-Associated Anaplastic Large Cell Lymphoma. *Aesthet Surg J.* 2017;37(7):771-775. <http://doi.org/10.1093/asj/sjw286>
20. Kaartinen I, Sunela K, Alanko J, Hukkinen K, Karjalainen-Lindsberg ML, Svarvar C. Breast implant-associated anaplastic large cell lymphoma - From diagnosis to treatment. *Eur J Surg Oncol.* 2017;43(8):1385-92. <https://doi.org/10.1016/j.ejso.2017.05.021>



# Criteria for evaluating studies at scientific medical events

René Aloisio da Costa Vieira<sup>1,2,3\*</sup> , Tatiana Carvalho de Souza Bonetti<sup>4</sup> ,  
Marcia Maria Chiquitelli Marques<sup>1</sup> , Gil Facina<sup>4</sup> 

## ABSTRACT

Medical journals value the quality of studies. Scientific events are spaces for discussion in the face of scientific advances, innovation and consensus. In them, space is opened for the presentation of clinical studies, translational studies, experience reports and videos, with the best-designed studies being selected and awarded. The lack of clear criteria allows for differences in assessments, making it difficult to place value on situations associated with research. In order to improve quality, it is necessary to evaluate ethics, the hierarchy of scientific evidence (methodology), the study design, the originality, the relevance, and the linearity of the material presented. The present study aims to discuss these points, presenting proposals to be used in the evaluation of clinical studies, translational studies, case reports and videos in scientific medical events.

**KEYWORDS:** scientific society; research design; ethics.

## CRITERIA FOR EVALUATING STUDIES AT SCIENTIFIC MEDICAL EVENTS

As medical literature expands, the need to improve objective criteria for analyzing the quality of scientific studies has increased. A hierarchy of evidence based on the quality of studies was created, which offers recommendations for use in clinical practice. Likewise, the number of studies in the area of molecular biology is increasing, a fact that allows support for clinical protocols, however, the medical population has difficulty in analyzing the quality of these studies and recognizing the hierarchy of evidence.

Scientific journals can be used as quality references for studies, as readers can analyze the impact, the article's citations and the researchers' performance. The journals present their editorial board, but there are a large number of articles to be evaluated. The editors evaluate the received article and verifies if it fits the scope of the journal. They later select associate editors to perform a second evaluation. There is a tendency to select new data, which will potentially be the basis for the bibliography of other studies and, consequently, will increase impact. It is then up to authors to create or present material that has been previously rarely addressed. Case reports are no longer a priority, since they are rarely cited. As such, specific magazines have come about for the publication of this type of content.

The fact is that many studies are not published for various reasons, such as limited quality, repetition of previously discussed findings, insufficient samples, deficiencies associated with data presentation, difficulty in choosing a specific journal, failure to convince editors about the quality of the research, as well as linguistic flaws.

Scientific events are consolidated and indirectly there is a hierarchy among them. There are major world events, American or European events, national events, state events and local events. It is possible to present a study orally, in a main auditorium, in parallel auditoriums, with posters, and with e-Posters etc. The works can be published in the annals of the events or in supplemental material from the specialty's magazines, and the content can be made available in print, online or through a digital presentation only on the event website.

It should be noted that scientific events have greater flexibility than scientific journals. This is because they are spaces reserved for discussion and the dissemination of knowledge, and are associated with the need to group professionals, creating spaces for the presentation of studies and new technologies and allowing for the improvement of interpersonal relationships, and the strengthening of specialties and services. Such facts determine greater flexibility in the analysis and selection of

<sup>1</sup>Hospital de Câncer de Barretos – Barretos (SP), Brazil.

<sup>2</sup>Faculdade de Medicina de Botucatu – Botucatu (SP), Brazil.

<sup>3</sup>Hospital de Câncer de Muriaé – Muriaé (MG), Brazil.

<sup>4</sup>Universidade Federal de São Paulo – São Paulo (SP), Brazil.

\*Corresponding author: reneacv@gmail.com

Conflict of interests: nothing to declare.

Received on: 05/20/2020. Accepted on: 06/01/2020.



studies to be presented at the event for the scientific community. In the selective selection process, there is a relationship between quality and quantity, a fact that is influenced by the availability of space and time for presentations; in addition to the need to include services and young researchers. To enhance the quality of studies, the best studies are given awards according to selection and classification rules and scores.

The scientific committee, which is usually made up of experts with a lot of experience in the specialty, has the task of selecting the best studies. However, there is no one rule to follow. This influences the selection of papers that will be accepted at the event, as well as their classification and whether they will be offered the chance to give an oral presentation and an award.

When registering a study for a specific event, the lack of rules limits how it is valued. As such, it is necessary to discuss general rules and how they will be scored for the scientific committees. This makes the study design and presentation easier for the author. Furthermore, it brings transparency and linearity to the scientific committee of a specialty. As such, the authors present themselves through general rules that should be evaluated, contextualized and adapted for each event or specialty, in the search for greater uniformity in the studies to be sent, analyzed, compared and potentially accepted in a specific scientific event.

## CRITERIA RELATED TO THE METHODOLOGY OF STUDIES

In the evaluation of the studies, it is suggested that the design, methodology (including statistical analysis), originality, authorization by the Research Ethics Committee, promotion and practical/social relevance be considered (Table 1). These items are substantiated by:

- The amount of evidence<sup>1</sup> is associated with the methodology of the study<sup>2-7</sup>, a fact that influences the quality of the study, the degree of recommendation<sup>8</sup> and use in clinical practice;
- Originality, bringing new aspects to light facilitates potential publication;
- Journals only accept articles if approved by a Research Ethics Committee. If this is not necessary, the Committee must state that it does not require an evaluation;
- The presence of funding suggests that the study was previously evaluated by a committee and, due to its merits, was given funding for carrying it out;
- A study's practical relevance, although not valued in publications, is important in specialty events, even in translational research, given its potential benefit to patients.

In order to facilitate the analysis in the methodology of the study, researchers can include and describe the use of scripts that are available in the literature proposed by Enhancing the Quality and Transparency of Health Research (EQUATOR) Network

(<https://www.equator-network.org>), the main methods being used in clinical studies:

- Preferred Reporting Items for Systematic Review and Meta-Analysis (PRISMA)<sup>2</sup> — systematic reviews;
- Consolidated Standards of Reporting Trials (CONSORT)<sup>3</sup> — randomized studies;
- Strengthening the Reporting of Observational Studies in Epidemiology (STROBE)<sup>4</sup> — observational studies;
- Reporting Recommendations for Tumor Marker Prognostic Studies (REMARK)<sup>5</sup> — prognostic markers;
- Standards for the Reporting of Diagnostic Accuracy Studies (STARD)<sup>6</sup> — diagnostic studies;
- Consensus-based Clinical Case Reporting Guideline (CARE)<sup>7</sup> — case studies.

In order to demonstrate prior approval by research committees, the numbers associated with this approval should be presented. The main ones are:

- The Research Ethics Committee approval number;
- The registration of randomized clinical studies in national (ReBEC) or international (ClinicalTrials) platforms;
- The agency that gave grants to the study and its number.

Many papers submitted to conferences constitute reports or a series of cases. Such studies should be evaluated in detail, given their frequency in national and regional conferences. The fact is that there is no classification for them, and many papers may not be accepted because the presentation was inadequate, because the rarity of the event was not valued, or because a particular and rare aspect of the case addressed was unable to be presented. For the best selection of these studies, several criteria are considered, which are presented in Table 2, in which the reports are evaluated for having approval by the local Research Ethics Committee; they are rare and complex based on the evaluation of the literature, innovation of the aspect addressed, description and detailed documentation of the case.

In addition to clinical studies, we should emphasize the importance of research in basic and translational science. While basic science employs experimental data that will provide a basis for clinical research, translational studies allow the research results to be moved from theory to clinical practice in the community<sup>9</sup>. For this, the methodology should be described in the greatest possible detail and evaluated respecting the caveats inherent to experimental studies (Table 3).

Given the current context, we suggest that scientific events analyze clinical studies, molecular biology studies and case reports separately, with the purpose of classifying them objectively and giving them awards in different categories. As such, there is the possibility of valuing good case reports so that they receive honorable mentions.

## FORMATTING OF THE STUDIES TO BE PRESENTED

The lack of specific formatting hinders an author's design and impairs the comparative evaluation of the reviewers. In order to standardize the studies that are prepared for scientific events, the criteria presented in Tables 1 to 3 are proposed:

- General presentation:
  - Study title;
  - Authors' names;
  - Institution where the study was carried out;
  - Number of words in the abstract, up to 300;
  - Text structured according to the type of study
    - clinical and molecular biology studies: introduction, materials and methods, results, conclusions;

**Table 1.** Proposal of criteria and scores to be used in conferences and scientific events.

Points	Criteria
	<b>Study methods</b>
2.8	Systematic review of randomized studies with or without a meta-analysis
2.4	Randomized experimental studies
2.0	Cohort Studies
1.6	Case control studies
1.2	Case series
0.8	Case report
0.4	Expert opinions
	<b>Research Ethics</b>
1.0	Approval from the ethics committee
1.0	No need for a Research Ethics Committee under Resolution No. 466
0.0	No description or evaluation by the ethics committee
	<b>Study Design</b>
2.5	Adequate description of the study with clear, reproducible methodology, consistent results and adequate conclusion that is compatible with the data presented. Approved through ClinicalTrials/ReBEC or something similar.
2.0	Adequate description of the study with clear, reproducible methodology, consistent results and adequate conclusion that is compatible with the data presented. Not approved through ClinicalTrials/ReBEC or something similar.
1.5	Adequate description of the study, however the methodology is weak (not reproducible), consistent results and adequate conclusion that is compatible with the data presented.
1.0	Adequate description of the study, however the methodology is weak (not reproducible), and the results and/or conclusions were not adequate for the data presented.
0.5	Severe failures in the introduction, methodology, results and conclusions.
0.0	Does not apply. Methodology and results not described.
	<b>Originality</b>
1.7	Unprecedented - new interpretation of the concept
1.2	Ratifies a known concept that is optional
0.7	Ratifies a classic concept that is used everyday
0.4	Does not introduce a new concept
	<b>Promotion</b>
1.0	Promotion from a public agency
0.5	Promotion from a private agency
0.0	Self-promotion or no promotion
	<b>Practical/social relevance</b>
1.0	Applicable at any center
0.5	Applicable only in a private or public center that is an exception (ex. has many resources)
0.0	No clinical applicability or does not fit

ReBEC: *Registro Brasileiro de Ensaio Clínicos* (Brazilian Registry of Clinical Trials).

- case report: introduction, case description, literature review and conclusion (optional if there are revisions);
- Study registration numbers: Research Ethics Committee; authorization of the patient — case reports that are not approved by the Research Ethics Committee, or that use photos, must have authorization signed by the patient or legal guardian, and this must be written in the text (example: “obtained authorization of the patient to use information”) —; clinical record (ReBEC or ClinicalTrials); promotion (agency, number); auxiliary methodology (PRISMA, CONSORT, STROBE, REMARK, STARD, CARE). At the discretion of the commission, giving proof of this data may or may not be requested.

## SCIENTIFIC VIDEOS

The use of scientific videos is frequent in surgical conferences in order to demonstrate technical and tactical aspects of surgery that are relevant and innovative, or to present tactics conducted by surgeons with extensive experience in specific procedures. The selection of videos is a little more complex due to the content of the abstract and the procedure to be presented in the proceedings of the event. Furthermore, the video itself needs to be evaluated since the best videos will be presented and discussed

in a specific place. Due to the different nature of videos, how they are awarded must also be different.

It is advisable that the abstract be structured, observing: an introduction to the theme, principal suggestions; a presentation of the particularities of the case or theme that justify the importance of the video; the technical care to be taken; and the main complications associated with the procedure.

In the video presentation rules, the time (5 to 7 min), the digital format (mp4, wmv, mpg, mpeg, avi, flv) and the minimum resolution (720 dpi) must be specified, in addition to the methodology used for sending and viewing it (Youtube, Dropbox).

Organization and linearity are the lifeblood of the video, demonstrated by an introduction to the topic, the presentation of particularities of the case that justify the importance of the video, the technique, the surgical tactic and the final result. Table 4 presents proposed criteria and specific scores for comparative video analysis.

## RESEARCH ETHICS

The Brazilian Resolution no. 466/2012 of the National Commission for Ethics in Research (Comissão Nacional de Ética em Pesquisa — CONEP) regulates studies that are carried out on humans and will be published<sup>10</sup>. Circular Letter 166/2018 regulates the publication of case reports<sup>11</sup>.

**Table 2.** Proposal of criteria to be used in conferences and scientific events for case reports and case series.

Points	Criteria
	<b>Research Ethics</b>
1.0	Approval by the ethics committee
0.5	Authorization from the patient
0.0	No description or evaluation from the Ethics Committee
	<b>Complexity</b>
2.0	Case with a systematic review
1.0	Case with no systematic review
0.5	Description exclusive to the case
	<b>Rarity</b>
4.0	Extremely rare (< 50 cases described)
3.0	Rare (< 200 cases described)
2.0	Uncommon (< 500 cases described)
0.5	Common
	<b>Aspect addressed</b>
1.0	Innovative
0.5	Common
	<b>Description</b>
2.0	Good and concise
1.0	Fair
0.5	Non-linear, confusing

Scientific events are spaces to discuss and disseminate knowledge among health professionals. They focus on a specialty, but they allow for a multi-professional space. The act of including ethical scores in studies aims to value and emphasize the care of this nature in human studies, in addition to identifying and selecting the best works, which will be presented in a free form or will be directed toward future publications. Similarly, including these scores in the videos aims to improve patient care and identify those with potential for publication.

Scientific events may have greater flexibility in relation to the presentation of findings. Care must be taken as to not unnecessarily submit studies to the CONEP system, if they are not meant for scientific publication. In the presence of case

reports and videos, regardless if they are included on Plataforma Brasil<sup>12</sup>, it is necessary to maintain patient confidentiality, even when using images. Patient consent is also essential and must be included in the medical record. In videos that demonstrate scientific experience or for case reports that won't be published, it does not make sense to have them be evaluated by the CONEP system.

## FINAL CONSIDERATIONS

If the event chooses to use a specific language, such as English, the author is responsible for the translation, and a study in a language other than the requested criterion will not be accepted.

**Table 3.** Proposal of criteria to be used in molecular biology studies.

Points	Criteria
	<b>Study methods</b>
2.8	Omics studies (genomics, transcriptomics, proteomics)
2.4	Functional studies ( <i>in vitro/in vivo</i> )
2.0	The identification of biomarkers (with validation methodology)
1.6	Case control studies
1.2	Descriptive studies without validation or without a control group
0.8	Studies that do not fit into the items previously mentioned
	<b>Study Design</b>
2.5	Description of the study is clear and has an adequate sample size, and methodology that is compatible with the objectives, results and conclusions
2.0	Description of the study is clear but there is no sample size that supports the proposed methodology and results (non-reproducible methodology)
1.5	Serious flaws in the description of the study, methodology and results
1.0	Does not apply. No methodology in the field of molecular biology
	<b>Research Ethics</b>
1.0	Approval by the Ethics Committee (or science for studies with commercial cell lines)
1.0	No need for a Research Ethics Committee under Resolution No. 466, and a description in the study
0.0	No description or evaluation from the Ethics Committee
	<b>Originality / Innovation</b>
1.7	Unprecedented — new interpretation of the concept
1.2	Ratifies a known concept that is optional
0.7	Ratifies a classic concept that is used everyday
0.4	Does not introduce a new concept
	<b>Promotion</b>
1.0	Promotion from a public agency
0.5	Promotion from a private agency
0.0	Self-promotion or no promotion
	<b>Clinical correlation</b>
1.0	In the study design and clinical practice
0.5	In the study design
0.0	Not applicable in clinical practice

**Table 4.** Proposal of criteria and scores to be used in conferences and scientific events for scientific videos.

Points	Criteria
	ABSTRACT
	<b>Ethics</b>
1.0	Authorization from the patient. Declaration of conflict of interest. Approval from the Ethics Committee (in the publication proposal).
0.5	Authorization by the patient and/or declaration of conflict of interest
0.0	No description or evaluation by the Ethics Committee
	<b>Structured Abstract</b>
1.5	Good, linear and concise
1.0	Fair
0.5	Non-linear, confusing
	<b>VIDEO</b>
	<b>Originality</b>
1.5	Relevant and Innovative
1.0	Relevant or Innovative
0.5	Common
	<b>Practical interest — clinical applicability</b>
1.5	Little-known procedure or adds new approach
1.0	Well-known procedure and adds new approach
0.5	Well-known procedure and does not add new approach
	<b>Didactic practices</b>
2.0	Linearity and clarity
1.0	Small technical limitations
0.5	Major technical limitations
	<b>Quality: image, sound and content</b>
1.5	Good presentation of the field and surgical tactics. Cleaning of the surgical field.
1.0	Small technical limitations
0.5	Major technical limitations
	<b>Interest: general format</b>
1.0	Compliance with the event rules (format, size)
0.5	Technical limitations

Some committees have sections in which the article should be designed according to its main characteristics, at the time of data inclusion. This will facilitate the organization of the annals and favor research by the event participants.

When inserting the data, the main author must indicate that it is authorized for publication in the annals of the event, and take responsibility for the property and veracity of the data presented.

The present work does not wish to present a rule, but a script to be used or improved for future events, which will assist researchers and scientific committees. Likewise, it intends to value aspects to be presented by the researcher, in order to demonstrate the seriousness and quality of his or her research.

Lastly, it aims to provide transparency and value the discussions present at the scientific event.

## AUTHORS' CONTRIBUTION

RACV, TCSB, MMCM and GF participated in all of the steps related to this publication. All authors performed: substantial contributions to the conception or design of the work; the acquisition, analysis, or interpretation of data for the work; the drafting of the work or critical revisions for important intellectual content; final approval of the version to be published; agreement to be accountable for all aspects of the work; and ensuring that questions related to the accuracy or integrity of any part of the work are appropriately investigated and resolved.

## REFERENCES

1. Cook DJ, Guyatt GH, Laupacis A, Sackett DL, Goldberg RJ. Clinical recommendations using levels of evidence for antithrombotic agents. *Chest*. 1995;108(4 Supl.):227S-30S. [http://doi.org/10.1378/chest.108.4\\_supplement.227s](http://doi.org/10.1378/chest.108.4_supplement.227s)
2. Stewart LA, Clarke M, Rovers M, Riley RD, Simmonds M, Stewart G, et al. Preferred Reporting Items for Systematic Review and Meta-Analyses of individual participant data: the PRISMA-IPD Statement. *JAMA*. 2015;313(16):1657-65. <http://doi.org/10.1001/jama.2015.3656>
3. Schulz KF, Altman DG, Moher D, Group C. CONSORT 2010 statement: updated guidelines for reporting parallel group randomised trials. *PLoS Med*. 2010;7(3):e1000251. <http://doi.org/10.1371/journal.pmed.1000251>
4. Vandembroucke JP, von Elm E, Altman DG, Gotzsche PC, Mulrow CD, Pocock SJ, et al. Strengthening the Reporting of Observational Studies in Epidemiology (STROBE): explanation and elaboration. *Int J Surg*. 2014;12(12):1500-24. <http://doi.org/10.1016/j.ijsu.2014.07.014>
5. McShane LM, Altman DG, Sauerbrei W, Taube SE, Gion M, Clark GM, Statistics Subcommittee of NCI EWGoCD. Reporting recommendations for tumor MARKer prognostic studies (REMARK). *Breast Cancer Res Treat*. 2006;100(2):229-35. <http://doi.org/10.1007/s10549-006-9242-8>
6. Cohen JF, Korevaar DA, Altman DG, Bruns DE, Gatsonis CA, Hooft L, et al. STARD 2015 guidelines for reporting diagnostic accuracy studies: explanation and elaboration. *BMJ Open*. 2016;6:e012799. <http://doi.org/10.1136/bmjopen-2016-012799>
7. Gagnier JJ, Kienle G, Altman DG, Moher D, Sox H, Riley D, et al. The CARE guidelines: consensus-based clinical case reporting guideline development. *J Med Case Rep*. 2013;7:223. <http://doi.org/10.1186/1752-1947-7-223>
8. Oxford Centre for Evidence-based Medicine. Nível de Evidência científica por tipo de estudo [Internet]. Oxford Centre for Evidence-based Medicine; 2020 [accessed on May 1, 2020]. Available at: [http://conitec.gov.br/images/Artigos\\_Publicacoes/Oxford-Centre-for-Evidence-Based-Medicine.pdf](http://conitec.gov.br/images/Artigos_Publicacoes/Oxford-Centre-for-Evidence-Based-Medicine.pdf)
9. Rubio DM, Schoenbaum EE, Lee LS, Scheingart DE, Marantz PR, Anderson KE, et al. Defining translational research: implications for training. *Acad Med*. 2010;85(3):470-5. <http://doi.org/10.1097/ACM.0b013e3181ccd618>
10. Padilha ARS. Resolução nº 466, de 12 de dezembro de 2012 [Internet]. Brasília: Conselho Nacional de Saúde; 2012 [accessed on May 1, 2020]. Available at: <http://www.conselho.saude.gov.br/resolucoes/2012/Reso466.pdf>
11. Venancio JAA. Carta Circular nº 166/2018-CONEP/SECNS/MS [Internet]. Brasília: Conselho Nacional de Saúde; 2018 [accessed on May 1, 2020]. Available at: <http://conselho.saude.gov.br/images/comissoes/conep/documentos/CARTAS/CartaCircular166.pdf>
12. Ministério da Saúde. Plataforma Brasil [Internet]. [accessed on May 1, 2020]. Available at: <http://plataformabrasil.saude.gov.br/login.jsf>



# Breast cancer neoadjuvant endocrine therapy and COVID-19: a renewed breath with future perspectives

Maria Carolina Gouveia<sup>1,2</sup> , Raffaella Levy de Andrade<sup>1,3</sup> , Larissa Cabral Marques<sup>1,3</sup> ,  
Candice Amorim de Araujo Lima Santos<sup>4,5</sup> , Ariani Impieri Souza<sup>6</sup> 

## ABSTRACT

In 2020, the COVID-19 pandemic is the major healthcare concern around the world. The infection is especially severe to those with immune system suppression, including patients with cancer. In order to mitigate the negative effects of COVID-19, guidelines have been developed by societies worldwide to review oncology care during this pandemic time. Neoadjuvant endocrine therapy (NET) is a well-established option for hormone positive (HR) HER2 negative breast cancer and showed a positive response in breast conservative surgery with substantially less toxicity. Compared to chemotherapy, the NET cost is lower, and its administration is easier, due to less medical visits. Even with remarkable advantages, NET remains taking less place in treatments than it might have. Periods of humanity crisis, such as World Wars and other pandemics, boosted the development of science and established many treatments, which are currently practiced. New data generated during the COVID-19 outbreak can inspire more trials comparing chemotherapy to endocrine therapy within the neoadjuvant setting. The purpose of this letter is to suggest NET as a safe low toxicity treatment strategy for breast cancer, not only to postpone breast cancer surgery during the pandemic, but also to become a standard therapy, a flame kept burning crossing the COVID-19 border.

**KEYWORDS:** breast neoplasms; coronavirus infections; neoadjuvant therapy; anastrozole; tamoxifen.

New coronavirus disease (COVID-19), caused by SARS-CoV-2, became a major healthcare concern in 2020. On March 11<sup>th</sup>, the World Health Organization (WHO) declared the COVID-19 outbreak a global pandemic.<sup>1</sup> Globally, as of August 2020, there have been over 23 million cases and 810,000 confirmed deaths, numbers which are certainly underestimated.<sup>2</sup>

COVID-19 is associated to different presentations, ranging from asymptomatic infections to pneumonia, severe acute respiratory syndrome, and death. Up to date, people older than 60 and/or those with immune system suppression, including patients with cancer, are more vulnerable to infection.<sup>2,3</sup>

Cancer patients need diagnosis, evaluation, and treatment even during a pandemic. It is relevant to consider them, however, immunocompromised and at an increased risk of experiencing COVID-19-related serious events (requirement for mechanical ventilation, intensive care admission, and/or death) when

compared to the general population.<sup>4,5</sup> Guidelines intending to reduce the negative effects of COVID-19 have been developed by oncology societies around the world.<sup>6,7</sup>

The Centers for Disease Control and Prevention and the American College of Surgeons have proposed to postpone elective surgeries, if possible. Evidence suggests that patients who received surgery and concomitantly contracted COVID-19 were at much higher risk of incurring severe clinical events than those who did not have surgery.<sup>6,7</sup> These new protocols have emphasized the importance of carefully selecting patients eligible for surgical procedures during this time.<sup>6</sup>

The decision of postponing cancer surgeries should be dimensioned with the possibility of disease progression, as well as face-to-face meetings to chemotherapy infusion or follow up consultations. COVID-19-free departments are an attractive alternative to provide greater safety for patients and staff, but their implementation takes time and is still an operational challenge.<sup>6,7</sup>

<sup>1</sup>Breast Surgery, Instituto de Medicina Integral Professor Fernando Figueira – Recife (PE), Brazil.

<sup>2</sup>Grupo Oncoclínicas – Recife (PE), Brazil.

<sup>3</sup>Real Instituto de Mastologia/Real Hospital Português – Recife (PE), Brazil.

<sup>4</sup>Clinical Oncology, Instituto de Medicina Integral Professor Fernando Figueira – Recife (PE), Brazil.

<sup>5</sup>Clinical Oncology, Rede D'Or – Recife (PE), Brazil.

<sup>6</sup>Gynecology, Instituto de Medicina Integral Professor Fernando Figueira – Recife (PE), Brazil.

\*Corresponding author: [raffaelandrade@hotmail.com](mailto:raffaelandrade@hotmail.com)

Conflict of interests: nothing to declare.

Received on: 06/29/2020. Accepted on: 08/31/2020.

Given the worldwide magnitude of breast cancer in terms of public health, reviewing care strategies is vital. With this article, we intend to present some data to review and encourage the use of neoadjuvant hormone-therapy during the COVID-19 crisis and after it.

During this viral outbreak, neoadjuvant therapies have been used to provide an opportunity for safely postponing breast cancer surgery.<sup>8</sup> If equivalent, approved oral therapy regimens are recommended instead of parenteral chemotherapy to reduce patients risk of exposure to the virus without compromising oncological outcomes.<sup>5,7</sup>

Neoadjuvant endocrine therapy (NET) is a low-toxicity approach to hormone receptor positive (HR) and HER2 negative breast cancer. NET effectiveness is equivalent to chemotherapy in downsizing tumors, raising breast conserving surgery in patients with HR positive disease, and providing information on endocrine responsiveness.<sup>9,10</sup> Several studies showed that monotherapy with aromatase inhibitors had a similar clinical, radiological, and breast conserving surgery rates than neoadjuvant standard chemotherapy, and both treatments had a low pathologic complete response (pCR) rate of roughly 10%.<sup>9,10</sup>

However, whereas neoadjuvant chemotherapy (NCT) is a common strategy, NET is underutilized, either due to an uncommon pathologic complete response after neoadjuvant endocrine therapy—expected for luminal breast tumors—or to the less useful prognostic information after treatment.<sup>10,11</sup> A recent study comparing NET *versus* NCT found 11% of nodal pCR in previous node-positive breast cancer treated with NET (not statistically different from NCT group), and 77% woman became eligible for breast conserving surgery (BCS).<sup>12</sup> NET is more likely to be successful in de-escalating breast surgery than axillary surgery, because pathologic complete response is not necessary to allow downstaging to BCS, but it is required to avoid axillary lymph node dissection after neoadjuvant treatments.<sup>12</sup>

NET is usually limited to the treatment of elderly postmenopausal women with large tumors, who were the worst candidates for NCT or upfront surgery. An examination of the United States National Cancer Data Base reveals that only 3% of potentially eligible patients received NET.<sup>10,11,13</sup> Evidence shows various benefits in the use of NET for a wider spectrum of patients (younger, including premenopause, and potentially candidates for up-front surgery).<sup>10,11,13</sup>

Regardless of the lack of pCR, NET results suggest that other primary endpoints should be considered. Until today, there was no evidence of an increased overall survival (OS) in patients who achieve pCR for HR positive tumors. The Preoperative Endocrine Prognostic Index (PEPI)—an index that combines, among other clinicopathologic factors, the residual Ki67 score and measurement of estrogen receptors during NET—has also found an application in clinical trials and NET as a potential endpoint. The idea of assessing clinical and biomarker responses has inspired the development of novel clinical trial designs for measuring the impact of endocrine agents.<sup>7-9</sup> Besides that, another motivating outcome is the number of patients who initially would have undergone radical surgeries and were converted into conservative breast surgeries after NET.<sup>14</sup>

Several advantages of NET can be especially valuable during a pandemic. When compared to anthracycline and taxane-based chemotherapy, NET has significantly lower toxicity. Some randomized trials comparing NET and NCT showed equivalent response and rate of breast conservative surgery for both treatments, with substantially less severe adverse events, such as neutropenia, febrile neutropenia, and cardiotoxicity in endocrine treatment.<sup>13,15</sup>

Endocrine therapy offers a lower cost, easier medication administration and, obviously, less visits to health units, not only to receive medication, but less hospitalizations due to side effects. All these factors, added to the safety and effectiveness of this type of neoadjuvant therapy, highlights NET as an excellent treatment option during the COVID-19 pandemic. Additionally, NET can show its value in the window trial space as treatment strategies for CDK4/6 inhibitors, and other new drugs and protocols are developed and continue to evolve.<sup>15-19</sup>

The present historical moment is helping the scientific community to rethink current practices, in which most positive HR breast cancer patients candidates to neoadjuvant therapy still receive chemotherapy, even experiencing less robust responses when compared to other molecular profiled tumors.<sup>15,19</sup>

The COVID-19 pandemic, just as other difficult periods of humanity, has not only changed daily routines, but also forced specialists to replan management options of cancer patients in these new times. During periods of crisis, generating opportune evidence for treatment options for cancer patients is vital for the community to identify best practices and optimized treatment plans for those susceptible to the virus. The higher risk of COVID-19-related complications for patients with cancer expresses the need for creating pragmatic approaches, and a deep review of potential available treatments.

Surgical entities suggest increasing the criteria for selecting candidates for up-front surgery. NET for luminal breast cancer can perform an important role in this unprecedented pandemic scenario for our generation; it combines a safe oncological outcome with less toxicity and exposure to the current unfavorable hospital environment. A rising number of patients undergoing NET is foreseen due to this current pandemic.

New data generated during the COVID-19 outbreak can inspire further research and trials to compare chemotherapy to endocrine therapy on the neoadjuvant scenario. More than ever, personalized medicine is the current goal to keep patients safe and healthy.

## AUTHORS' CONTRIBUTIONS

M.G.: Conceptualization, project administration, supervision, validation, visualization, investigation, methodology, writing — review & editing.

R.A.: Project administration, supervision, validation, visualization, investigation, methodology, writing — review & editing.

L.M.: Writing — review & editing, formal analysis.

C.S.: Formal analysis, review & editing.

A.S.: Formal analysis, review & editing.





## REFERENCES

- World Health Organization. Director General's opening remarks at the media briefing on COVID-19 [Internet]. World Health Organization; 2020 [accessed on May 26, 2020]. Available at: <https://www.who.int/dg/speeches/detail/who-director-general-s-opening-remarks-at-the-media-briefing-on-covid-19--11-march-2020>
- Wu Z, McGoogan JM. Characteristics of and Important Lessons from the Coronavirus Disease 2019 (COVID-19) Outbreak in China: Summary of a Report of 72314 Cases from the Chinese Center for Disease Control and Prevention. *JAMA*. 2020;323(13):1239-42. <https://doi.org/10.1001/jama.2020.2648>
- Sidaway P. COVID-19 and cancer: what we know so far. *Nat Rev Clin Oncol*. 2020;17:336. <https://doi.org/10.1038/s41571-020-0366-2>
- Yu J, Ouyang W, Chua MLK, Xie C. SARS-CoV-2 Transmission in Patients with Cancer at a Tertiary Care Hospital in Wuhan, China. *JAMA Oncol*. 2020;6(7):1108-10. <https://doi.org/10.1001/jamaoncol.2020.0980>
- Gosain R, Abdou Y, Singh A, Rana N, Puzanov I, Ernstoff MS. COVID-19 and Cancer: a Comprehensive Review. *Curr Oncol Rep*. 2020;22(5):53. <https://doi.org/10.1007/s11912-020-00934-7>
- American College of Surgeons. COVID 19: Elective Case Triage Guidelines for Surgical Care 2020 [Internet]. 2020 [cited on May 15, 2020]. Available at: <https://www.facs.org/covid-19/clinical-guidance/elective-case/breast-cancer>
- Curigliano G, Cardoso MJ, Poortmans P, Gentilini O, Pravettoni G, Mazzocco K, et al. Recommendations for triage, prioritization and treatment of breast cancer patients during the COVID-19 pandemic. *Breast*. 2020;52:8-16. <https://doi.org/10.1016/j.breast.2020.04.006>
- Marti C, Sánchez-Méndez JI. Neoadjuvant endocrine therapy for luminal breast cancer treatment: a first-choice alternative in times of crisis, such as the COVID-19 pandemic. *Ecancer*. 2020;14:1027. <https://doi.org/10.3332/ecancer.2020.1027>
- Palmieri C, Cleator S, Kilburn LS, Kim SB, Ahn SH, Beresford M, et al. NEOCENT: a randomised feasibility and translational study comparing neoadjuvant endocrine therapy with chemotherapy in ER-rich postmenopausal primary breast cancer. *Breast Cancer Res Treat*. 2014;148(3):581-90. <https://doi.org/10.1007/s10549-014-3183-4>
- Spring LM, Gupta A, Reynolds KL, Gadd MA, Ellisen LW, Isakoff SJ, et al. Neoadjuvant endocrine therapy for estrogen receptor-positive breast cancer a systematic review and meta-Analysis. *JAMA Oncol*. 2016;2(11):1477-86. <https://doi.org/10.1001/jamaoncol.2016.1897>
- Charehbili A, Fontein DBY, Kroep JR, Liefers GJ, Mieog JSD, Nortier JWR, et al. Neoadjuvant hormonal therapy for endocrine sensitive breast cancer: A systematic review. *Cancer Treat Rev*. 2014;40(1):86-92. <https://doi.org/10.1016/j.ctrv.2013.06.001>
- Montagna G, Sevilimedu V, Fornier M, Jhaveri K, Morrow M, Pilewskie ML. How Effective is Neoadjuvant Endocrine Therapy (NET) in Downstaging the Axilla and Achieving Breast-Conserving Surgery? *Ann Surg Oncol*. 2020. <https://doi.org/10.1245/s10434-020-08888-7>
- Chiba A, Hoskin TL, Heins CN, Hunt KK, Habermann EB, Boughey JC. Trends in Neoadjuvant Endocrine Therapy Use and Impact on Rates of Breast Conservation in Hormone Receptor-Positive Breast Cancer: A National Cancer Data Base Study. *Ann Surg Oncol*. 2017;24(2):418-24. <https://doi.org/10.1245/s10434-016-5585-5>
- Guerrero-Zotano AL, Arteaga CL. Neoadjuvant trials in ER+ breast cancer: A tool for acceleration of drug development and discovery. *Cancer Discov*. 2017;7(6):561-74. <https://doi.org/10.1158/2159-8290.CD-17-0228>
- Murphy CG. The Role of CDK4/6 Inhibitors in Breast Cancer. *Curr Treat Options Oncol*. 2019;20(6):52. <https://doi.org/10.1007/s11864-019-0651-4>
- Wang Y, He L, Song Y, Wu Q, Wang H, Zhang B, et al. The tumour response of postmenopausal hormone receptor-positive breast cancers undergoing different types of neoadjuvant therapy: A meta-analysis. *BMC Womens Health*. 2020;20(1):17. <https://doi.org/10.1186/s12905-020-0879-y>
- Dietz JR, Moran MS, Isakoff SJ, Kurtzman SH, Willey SC, Burstein HJ, et al. Recommendations for prioritization, treatment, and triage of breast cancer patients during the COVID-19 pandemic. the COVID-19 pandemic breast cancer consortium. *Breast Cancer Res Treat*. 2020;181(3):487-97. <https://doi.org/10.1007/s10549-020-05644-z>
- American Society of Breast Surgeons. ASBrS Resource Guide to Endocrine Therapy in the COVID-19 Pandemic. American Society of Breast Surgeons; 2020.
- Curigliano G, Gómez Pardo P, Meric-Bernstam F, Conte P, Lolkema MP, Beck JT, et al. Ribociclib plus letrozole in early breast cancer: A presurgical, window-of-opportunity study. *Breast*. 2016;28:191-8. <https://doi.org/10.1016/j.breast.2016.06.008>



# Plagiarism in scientific publications

Gil Facina<sup>1</sup> , Francisco Pimentel Cavalcante<sup>2</sup> , Régis Resende Paulinelli<sup>3,4</sup> , René Aloisio da Costa Vieira<sup>5\*</sup> 

## ABSTRACT

Plagiarism in scientific publications is a topic of fundamental importance and rarely addressed in the literature. It is associated with ethical issues that go beyond research itself, a fact that values the discussion on the topic. The concept, the main types of plagiarism, ethical relationships, preventive methodologies aiming to minimize their occurrence, diagnostic methodologies, and potential penalties involved are discussed. Every researcher and team involved in publishing articles should be aware of the importance and relevance of not plagiarizing, since being cautious about it is essential to build a solid curriculum on the part of the researcher, and credibility on the part of scientific journals.

**KEYWORDS:** plagiarism; scientific misconduct; codes of ethics; publications.

## PLAGIARISM IN SCIENTIFIC PUBLICATIONS

In the dictionary, the term plagiarism implies the act or effect of plagiarizing, copying, imitating, or reproducing.<sup>1</sup> From a legal point of view, stealing an idea is like stealing someone's property.<sup>2</sup> Scientific journals have been increasingly concerned in this regard, considering that although authors transfer their copyright to journals, they maintain responsibility for the written material, and the occurrence of plagiarism may imply loss of authors' reputation and/or scientific journal. When evaluating the term plagiarism on Medical Subject Headings (MeSH), less than two thousand references are observed in PubMed,<sup>3</sup> and, when associated with the term Brazil or Brazilian, there are less than 25 publications, a fact that suggests the need for discussing this subject, still incipient in Brazil, in order to address the concepts involved, preventive measures, and evaluation methodologies.

Today, when writing a scientific article, authorship is often divided due to the difficulty of carrying out innovative and complex research, and many authors, in their study groups, come to believe in the reputation of their team, which can be compromised if one of the collaborators plagiarizes. As to younger researchers, there is a desire to publish, unaware that plagiarism shares conceptual and philosophical similarities with

cheating on an exam. Likewise, for senior researchers, publication in indexed journals is a fundamental factor in their academic life in research institutions. Senior researchers and scientific journals are responsible for preserving the image they build over time.

Ethics is not only associated with the submission of the study to a committee for conducting research, but it is also present in the preparation of the text, in which the practice of plagiarism poses ethical questions.<sup>4</sup> Thus, scientific journals request that authors take responsibility for the originality of the publication, obtaining their signature or consent through e-mail.

Public retraction associated with publications may be due to misconduct, gross errors or fraud, with plagiarism being the main factor.<sup>5</sup> From a writing point of view, plagiarism can be considered substantially copying and pasting, making a literal copy of a text, paraphrasing (placing words in the middle of copied text), or recycling a text (self-plagiarism).<sup>6</sup> We can also divide plagiarism into four main forms:<sup>7</sup>

- **Form:** it represents the copy of sentences or sentences taken from another text;
- **Content:** uses previous data, without the given express authorization of the author, such as definitions, figures, and images;

<sup>1</sup>Universidade Federal de São Paulo – São Paulo (SP), Brazil.

<sup>2</sup>Hospital Geral de Fortaleza – Fortaleza (CE), Brazil.

<sup>3</sup>Hospital Araújo Jorge, Associação de Combate ao Câncer de Goiás – Goiânia (GO), Brazil.

<sup>4</sup>Hospital das Clínicas da Universidade Federal de Goiás – Goiânia (GO), Brazil.

<sup>5</sup>Hospital do Câncer de Muriaé, Fundação Cristiano Varella – Muriaé (MG), Brazil.

\*Corresponding author: reneacv@terra.com.br

Conflict of interests: nothing to declare.

Received on: 08/05/2020. Accepted on: 08/07/2020

- **Concept:** it consists of the appropriation of research methods, experimental procedures, or argued structures. Authors must use their own words and ideas and be careful, and remember to cite the authors who presented similar concepts;
- **Self-plagiarism:** authors, as they carry out research in the line, transfer copyright to journals when publishing a study. Therefore, care should be taken when preparing their texts. When many works are published on the same project, authors must try not to repeat the narration or present the same information. The limits are not well defined in the literature, but this situation urges for care and attention.<sup>8</sup>

Some measures are suggested to reduce plagiarism, among them: the education of researchers on the subject; the institution of policies for revising the material by undergraduate and graduate programs, and scientific journals; the monitoring of content and the creation of internal penalty mechanisms, such as the refusal to publish in scientific journals and even the suspension of research programs.<sup>9,10</sup>

For the authors, one of the ways to avoid plagiarism may be to organize ideas previously, before the writing itself begins. Thus, before starting text elaboration, a proper bibliographic review is suggested, in which different concepts are marked in the references, and, later, the grouping of references into concepts is performed. Junior researchers are advised to avoid the use of textbooks, using these only to understand the subject, which should be followed by a literature review. The selection of review articles, systematic reviews, and meta-analyses greatly facilitates problem understanding, but writing must be based on the understanding and presentation of the concepts and ideas, followed by references that support the statements. The use of references from textbooks is not recommended, preferring the use of original articles published in recent years. After understanding the topic and the potential concepts to be presented, these should be organized into paragraphs to create a linearity of ideas and justify the introduction and discussion. The results should be compared to previous publications, highlighting the potential differences between the studies, a fact that values the publication. The task is not easy and requires time, effort, dedication, and teamwork. Researchers are not born ready, they learn from their mistakes.

Reading and rereading, care with the content and reflection on it qualify the material presented. The text must be linear, and multiple adjustments are often necessary until the final version is reached. The journals request the description of the individual participation of each author in the construction of the text, and the review of the text by the entire team is required, a fact that aims to minimize problems related to the understanding and to maximize the quality of the material. Another point to be discussed is the need to use a table

or figure, or part of them, which were previously published. The simple citation of the source does not authorize researchers to use them. Granting of rights to use by the author or the scientific journal is needed, along with the citation of the source. In the case of systematic reviews and meta-analyses, this is not necessary, since raw data will be used and the author who collected such information will be cited.

There is a range of plagiarism detection software, such as Turnitin®, Ephorus®, WCopyfind®, as well as websites that carry out this assessment, such as iThenticate® ([www.ithenticate.com](http://www.ithenticate.com)), JPlag® ([www.jplag.de/](http://www.jplag.de/)), Plagiarism Combat® (<http://www.plagiarismcombat.com>), Viper® (<https://www.scanmysay.com>), checkForm®, and Plagiarism® (<https://www.checkforplagiarism.net>)<sup>11,12</sup>.

When analyzing the text in a plagiarism detector program, they evaluate similarities between publications, as well as between published references, displaying phrases, references and, finally, a percentage of similarities. Authors should be careful when writing their text to avoid using few sources and respective references, and reviewers should be careful when evaluating percentages and crossing data. It is up to the editor to evaluate the content presented and observe the similarities in the phrases, ideas, and references.

These software analyze similarities between phrases, paragraphs, and articles, which are identified by colors, and, finally, present partial and total similarity scores that will allow the reviewers a more careful analysis. There is no limit defined as acceptable for plagiarism. There are several indices in the literature, such as 5, 10, and 20%.<sup>10,13</sup> A study that evaluated the potential cutoff for considering plagiarism, when using the iThenticate® software, found the 15% similarity limit to be acceptable.<sup>14</sup> However, currently, there is a zero tolerance policy in international and national journals.

Every researcher and their team must be aware of the importance and relevance of not plagiarizing, thus allowing a climate of trust between authors and editors, a fact that motivated the present discussion. Measures and care related to plagiarism are fundamental in building a solid curriculum on the part of the researcher, and credibility on the part of scientific journals.

## AUTHORS' CONTRIBUTION

G.F.: Conceptualization, Data curation, Formal analysis, Project administration, Writing – original draft.

F.P.C.: Conceptualization, Data curation, Formal analysis, Writing – original draft.

R.R.P.: Conceptualization, Data curation, Formal analysis, Writing – original draft.

R.A.C.V.: Conceptualization, Data curation, Formal analysis, Project administration, Writing – original draft.

## REFERENCES

1. Michaelis. Dicionário Brasileiro da língua Portuguesa [Internet]. [cited on Aug 4, 2020]. Available at: <https://michaelis.uol.com.br/moderno-portugues/busca/portugues-brasileiro/Plágio/>
2. JusBrasil. Plágio: quando a cópia vira crime [Internet]. JusBrasil; 2012 [cited on Aug 4, 2020]. Available at <https://stj.jusbrasil.com.br/noticias/3174944/plagio-quando-a-copia-vira-crime>
3. PubMed [Internet]. Bethesda: National Library of Medicine; c2012 [cited on July 31, 2020]. Available from: <https://pubmed.ncbi.nlm.nih.gov>
4. Benos DJ, Fabres J, Farmer J, Gutierrez JP, Hennessy K, Kosek D, et al. Ethics and scientific publication. *Adv Physiol Educ.* 2005;29(2):59-74. <https://doi.org/10.1152/advan.00056.2004>
5. Stavale R, Ferreira GI, Galvão JAM, Zicker F, Novaes M, Oliveira CM, et al. Research misconduct in health and life sciences research: A systematic review of retracted literature from Brazilian institutions. *PLoS One.* 2019;14(4):e0214272. <https://doi.org/10.1371/journal.pone.0214272>
6. Debnath J. Plagiarism: A silent epidemic in scientific writing - Reasons, recognition and remedies. *Med J Armed Forces India.* 2016;72(2):164-7. <https://doi.org/10.1016/j.mjafi.2016.03.010>
7. Chamon W, Dantas PE. What is plagiarism after all? *Arq Bras Oftalmol.* 2016;79(2):V-VI. <http://dx.doi.org/10.5935/0004-2749.20160021>
8. MacDermid JC. Self-plagiarism is not easily defined, but should be avoided. *J Hand Ther.* 2018;31(4):427-8. <https://doi.org/10.1016/j.jht.2018.10.001>
9. Guraya SY, Guraya SS. The confounding factors leading to plagiarism in academic writing and some suggested remedies: A systematic review. *J Pak Med Assoc.* 2017;67(5):767-72.
10. Kadam D. Academic integrity and plagiarism: The new regulations in India. *Indian J Plast Surg.* 2018;51(2):109-10. [https://dx.doi.org/10.4103%2Fijps.IJPS\\_208\\_18](https://dx.doi.org/10.4103%2Fijps.IJPS_208_18)
11. Araújo ERO. The plagiarism in scientific research of higher education. *RCA.* 2017;2(1):93-107.
12. Kumar PM, Priya NS, Musalaiah S, Nagasree M. Knowing and avoiding plagiarism during scientific writing. *Ann Med Health Sci Res.* 2014;4(Suppl. 3):S193-8. <https://dx.doi.org/10.4103%2F2141-9248.141957>
13. Memon AR. Similarity and Plagiarism in Scholarly Journal Submissions: Bringing Clarity to the Concept for Authors, Reviewers and Editors. *J Korean Med Sci.* 2020;35(27):e217. <https://dx.doi.org/10.3346%2Fjkms.2020.35.e217>
14. Higgins JR, Lin FC, Evans JP. Plagiarism in submitted manuscripts: incidence, characteristics and optimization of screening-case study in a major specialty medical journal. *Res Integr Peer Rev.* 2016;1:13. <https://doi.org/10.1186/s41073-016-0021-8>



# The first mastectomy: truth or legend?

Luiz Marinho<sup>1,2\*</sup> 

Radical breast mastectomy is tied to the name William Halsted. He is regarded as the pioneer in performing radical surgery as the effective way to treat breast cancer in 19<sup>th</sup> century. Some publications record that the first radical mastectomy occurred in 1882 at New York<sup>1</sup>. However, there is record that it was occurred at John Hopkins Medical School in Baltimore<sup>2</sup>. There is two register to the year of the first surgery from professor Halsted, 1882<sup>3</sup> and 1889<sup>4</sup>.

In 1984, Halsted published the 50 cases that he operated with a recurrence rate of 6%, while in Europe the recurrence rate were from 51% to 82%, because they did not use the surgical technique described by Halsted.

## LISTER AND BREAST CANCER SURGERY

Joseph Lister, surgeon and chief of surgery at the University of Glasgow-Scotland, was researching some substance that could prevent contamination of surgical wounds. Suddenly, in the summer of 1867, Lister was approached by his sister, Isabella Lister Pinn. She had a breast cancer and she had already sought a surgeon in London and another in Edinburgh, Scotland. None of them accepted to treat her.

Lister had no way to refusing the treatment to his sister. He travelled to Edinburgh to discuss the situation with professor Syme, one of the doctors who had examined Isabella before. Syme was Lister's father-in-law and chief of surgery at Edinburgh Hospital.

Doctor Lister shared with his father-in-law that he had good results after surgery using carbolic acid as an antiseptic, and many patients have left the hospital in Glasgow without problems with surgical scarring, since he started using the antiseptic solution to prevent infections. Lister believed the germ theory and he was employing antiseptic treatment since he had read the papers from Louis Pasteur. Syme accepted the arguments of this former assistant. If there was any hope to Isabella, it was the surgery plus carbolic acid as a prevention the suppuration of the wound.

Lister returned from Edinburgh and devoted himself to working in the anatomy room from Glasgow's University, to familiarize himself with the anatomy of woman's chest.

In June 16, 1867, the patient was operated. Lister decided to carry out the operation in his own home, and the dining table was adapted to be an operating table. Lister feared that Isabella could more chance to have an infection if he made the surgery in the hospital. Chloroform was used to anesthetize Isabella. The instruments to the surgery had been dipped in carbolic acid. The gauze and everything that it would be used was sanitized with carbolic acid. Lister and three other surgeons also claimed their hands with carbolic acid<sup>5</sup>.

Hector Cameron was one of Lister's assistant and wrote that Lister believed that if hands and skin were thoroughly washed in carbolic lotion and instruments and drapes soaked in it, then a safe elective surgery could be undertaken<sup>6</sup>.

Lister removed the breast tissue, muscles and lymph nodes. It was the same surgery published by Halsted in 1894. Isabella stayed in the Lister's house until she got well. Isabella's wound healed without suppuration due to Lister's careful application of carbolic acid during and after her procedure. She lived three years after the treatment at Glasgow, but she died because she had a relapse in the liver.

Lister published in *The Lancet* one paper entitled: *Lister covered her chest*. He did not announced a new technique surgery for breast cancer. The goal was to prevent surgery infection using carbolic acid. This paper was published in 1875, exactly 19 years before the paper published by Halsted<sup>7</sup>.

Isabella's story was one of the stories of the life of Lister in Scotland. Lister had no alternative, he must help Isabella. He continued to research how to prevent infections. Halsted opened the way for mastologists around the world. Halsted was for us as the lighthouse of knowledge that showed us what and how we could treat women with breast cancer. Just Neil Armstrong in the moon, Halsted gave the first step to a new era of treatment of breast cancer.

<sup>1</sup>Universidade do Oeste de Santa Catarina – Joaçaba (SC), Brazil.

<sup>2</sup>Hospital Unimed – Chapecó (SC), Brazil.

\*Corresponding author: lbmarinho@uol.com.br

Conflict of interests: nothing to declare.

Received on: 10/01/2020. Accepted on: 10/17/2020.

## REFERENCES

1. Kinne WD. Primary treatment of breast cancer. In: Harrys JH, Hellman S, Henderson CI, Kinne WD, eds. Breast disease. 2<sup>a</sup> ed. Pennsylvania: Lippincott; 1991. Chapter 16, p. 347.
2. Wagner Jr. BF. History of breast disease and its treatment. In: Wagner Jr. BF, ed. The breast. Philadelphia: Saunders, Bland & Copeland; 1991. Chapter 1., p. 10.
3. Moura DL. História do tratamento cirúrgico do cancro da mama: empirismo e ciência. *Rev Port Cir.* 2013;(27):41-58.
4. Cavalcante PF. História Halsted antes da fama. *Mastology News.* 2016;20:13.
5. Fitzharris L. The Butchering Art. In: Lane A, ed. *The Storm.* Great Britain: Clays Ltd, St Yves plc; 2017. Chapter 9, p. 177.
6. Jones PF. The friendship of Joseph Lister and Hector Cameron. *J Med Biogr.* 2001;9(3):143-50. <https://doi.org/10.1177/096777200100900304>
7. Fitzharris L. The Butchering Art. In: *Notes.* Great Britain: Clays Ltd, St Yves plc; 2017, p. 259.



